



Epson[®] SureColor[®] P5000 User's Guide

Contents

Epson SureColor P5000 User's Guide	9
Introduction to Your Printer	10
Printer Features	10
Optional Equipment and Replacement Parts	10
Notations Used in the Documentation	11
Printer Part Locations	11
Product Parts - Front	12
Product Parts - Top/Inside	13
Product Parts - Rear/Spindle	14
Control Panel Parts	15
Media Handling	19
Roll Paper Handling	19
Removing the Roll Media Adapter - 2-inch Core	19
Installing the Roll Media Adapter - 3-inch Core	20
Loading Roll Paper on the Spindle	21
Installing the Borderless Spacer	23
Loading Roll Paper	24
Cutting Roll Paper	28
Cutting Roll Paper Manually	29
Printing Trim Lines	29
Removing Roll Paper	30
Cut Sheet Handling	31
Loading Cut Sheets in the Paper Cassette	32
Loading Cut Sheets in the Rear Manual Feeder	39
Loading Cut Sheets in the Front Manual Feeder	42
Adjusting the Platen Gap	44
Creating Custom Paper Configurations	45
Printing a Custom Paper Configuration List	47
Selecting Custom Paper Configurations	47
Available Epson Papers	47

Borderless Paper Type Compatibility	54
Printing from a Computer	56
Printing with Windows	56
Selecting Basic Print Settings - Windows	56
Paper Configuration Options - Windows	60
Advanced B&W Photo Options - Windows	61
Print Quality Options - Windows	62
Color Management Options - Windows	62
Advanced Color Controls - Windows	64
Paper Source Options - Windows	64
Roll Paper Options - Windows	65
Using Layout Manager - Windows	68
Selecting Print Layout Options - Windows	74
Reduce/Enlarge Options - Windows	75
Multi-Page Printing Options - Windows	75
Selecting Additional Settings - Windows	76
Printing Your Document or Photo - Windows	78
Checking Print Status - Windows	80
Saving, Sharing, and Customizing the Printer Settings	80
Saving and Sharing Print Settings - Windows	80
Saving and Sharing Media Settings - Windows	82
Editing Print Setting Displays - Windows	83
Selecting Default Print Settings - Windows	85
Changing the Language of the Printer Software Screens	86
Changing Automatic Update Options	88
Printing on a Mac	88
Selecting Basic Print Settings - Mac	89
Advanced Color Settings - Mac	93
Output Resolution Settings - Mac	96
Print Options - Mac	96
Selecting Print Layout Options - Mac	97
Selecting Roll Paper Settings - Mac	97
Selecting Advanced Media Control Settings - Mac	100

Advanced Media Control Options - Mac.....	101
Managing Color - Mac	101
Color Matching Options - Mac.....	102
Sizing Printed Images - Mac.....	103
Selecting Printing Preferences - Mac	103
Printing Preferences - Mac.....	104
Printing Your Document or Photo - Mac	105
Checking Print Status - Mac.....	107
Using the Control Panel Menus.....	108
Accessing the Printer's Menus	108
Maintenance Menu Settings.....	108
Paper Menu Settings.....	110
Printer Setup Menu Settings	114
Printer Status Menu Settings.....	117
Network Setup Menu Settings	117
Preferences Menu Settings	118
Administrator Menu Settings	120
Replacing Ink Cartridges and Maintenance Tanks	121
Checking Ink and Maintenance Tank Status with Windows	121
Checking Ink and Maintenance Tank Status on a Mac.....	122
Purchase Epson Ink Cartridges and Maintenance Tanks.....	123
Ink Cartridge and Maintenance Tank Part Numbers.....	124
Removing and Installing Ink Cartridges.....	125
Replacing Maintenance Tanks	128
Replacing the Ink Maintenance Tank	128
Replacing the Borderless Maintenance Tank	131
Switch Black Ink Type	135
Switching the Black Ink Type.....	135
Black Ink Type Media List.....	135
Adjusting Print Quality.....	138
Print Head Maintenance.....	138
Print Head Nozzle Check.....	138
Printless Nozzle Check.....	138

Checking the Nozzles Using the Product Control Panel	139
Checking the Nozzles Using a Computer Utility	140
Print Head Cleaning	142
Cleaning the Print Head Using the Product Control Panel	142
Cleaning the Print Head Using a Computer Utility	144
Using the Powerful Cleaning Utility	146
Print Head Alignment	147
Aligning the Print Head Automatically Using a Computer Utility	148
Aligning the Print Head Automatically Using the Product Control Panel	149
Aligning the Print Head Manually Using the Product Control Panel	149
Maintenance and Transportation	152
Cleaning Your Product	152
Cleaning the Roll Paper Feed Slot	154
Replacing the Cutter	156
Moving or Transporting Your Product	162
Solving Problems	164
Product Status Messages	164
Solving Printer Problems	171
Printer Does Not Turn On	172
LCD Screen Shuts Off	172
Solving Printing Problems	172
Nothing Prints	172
Cannot Print Over a Network	173
Print Head Moves But Nothing Prints	173
Solving Paper Problems	174
Paper Feeding Problems	174
Roll Paper Jam Problems	175
Cut Sheet Paper Jam Problems in the Paper Cassette	177
Cut Sheet Paper Jam Problems in the Front or Rear Manual Feeder	178
Solving Print Quality Problems	179
Nozzle Check Pattern Prints Incorrectly	179
Overall Print Quality is Poor	180
Lines Are Misaligned	181

Prints are Scuffed or Smeared	181
Margins Appear in Borderless Roll Prints	182
Too Much Ink is Consumed	183
Where to Get Help.....	183
Technical Specifications	185
Windows System Requirements	185
Mac System Requirements	186
Paper Specifications	186
Printable Area Specifications	188
Ink Cartridge Specifications.....	189
Dimension Specifications	190
Electrical Specifications	191
Environmental Specifications	191
Interface Specifications	192
Safety and Approvals Specifications	192
Notices	193
Important Safety Instructions.....	193
General Product Safety Instructions	193
Ink Cartridge Safety Instructions.....	195
FCC Compliance Statement.....	196
Trademarks	196
Copyright Notice.....	197
A Note Concerning Responsible Use of Copyrighted Materials.....	197
Copyright Attribution	198

Epson SureColor P5000 User's Guide

Welcome to the Epson SureColor P5000 *User's Guide*.

For a printable PDF copy of this guide, [click here](#).

Introduction to Your Printer

Refer to these sections to learn more about your printer and this manual.

[Printer Features](#)

[Notations Used in the Documentation](#)

[Printer Part Locations](#)

Printer Features

The Epson SureColor P5000 printer includes these special features:

High productivity

- PrecisionCore print head capable of 10 channels with 360 nozzles per inch
- Available 200 ml high-capacity ink cartridges with increased black density
- Auto-switching between roll paper and high-capacity cut sheet cassette

Reliability

- Improved dust and static control for reduced print head nozzle maintenance
- Ink-repellent print head surface for reduced nozzle clogging

High resolution

- Prints at resolutions up to 2880 x 1440 dpi
- Supports variable-sized droplet technology as small as 3.5 picoliter

Easy-to-use setup and operation

- Intuitive, easy-to-read, color LCD display
- Four media paths, all front-loaded for easy access
- Easy-to-use software

[Optional Equipment and Replacement Parts](#)

Parent topic: [Introduction to Your Printer](#)

Optional Equipment and Replacement Parts

You can purchase genuine Epson ink, paper, and accessories from an Epson authorized reseller. To find the nearest reseller, visit proimaging.epson.com (U.S.) or proimaging.epson.ca (Canada), select

your product series and product, and click the **Where to Buy** button. Or call 800-GO-EPSON (800-463-7766) in the U.S. or 800-807-7766 in Canada.

Option or part	Part number
Replacement ink maintenance tank (maintenance box 1)	T6190
Replacement borderless maintenance tank (maintenance box 2)	T6191
Additional 2"/3" roll media spindle	C12C811251
Replacement printer cutter blade	C12C815351
Cleaning sheets	C13S400045
SpectroProofer 17" UVS	Spectro17UVS
1-year extended Epson Preferred Plus service plan for SpectroProofer	EPPSPB1
1-year extended Epson Preferred Plus service plan	EPP49B1
2-year extended Epson Preferred Plus service plan	EPP49B2

Parent topic: [Printer Features](#)

Notations Used in the Documentation

Follow the guidelines in these notations as you read your documentation:

- **Warnings** must be followed carefully to avoid bodily injury.
- **Cautions** must be observed to avoid damage to your equipment.
- **Notes** contain important information about your printer.
- **Tips** contain additional printing information.

Parent topic: [Introduction to Your Printer](#)

Printer Part Locations

Check the printer part illustrations to learn about the parts on your printer.

[Product Parts - Front](#)

[Product Parts - Top/Inside](#)

[Product Parts - Rear/Spindle](#)

[Control Panel Parts](#)

Parent topic: [Introduction to Your Printer](#)

Product Parts - Front

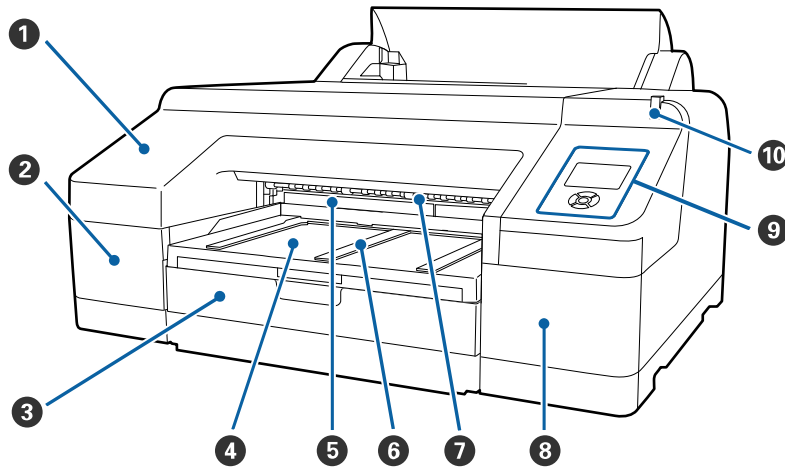

- 1 Front cover
- 2 Ink cartridge cover (left)
- 3 Paper cassette
- 4 Output tray
- 5 Borderless maintenance tank (maintenance box 2)
- 6 Paper eject support
- 7 Front manual feeder
- 8 Ink cartridge cover (right)
- 9 Control panel
- 10 Alert light

Parent topic: [Printer Part Locations](#)

Product Parts - Top/Inside

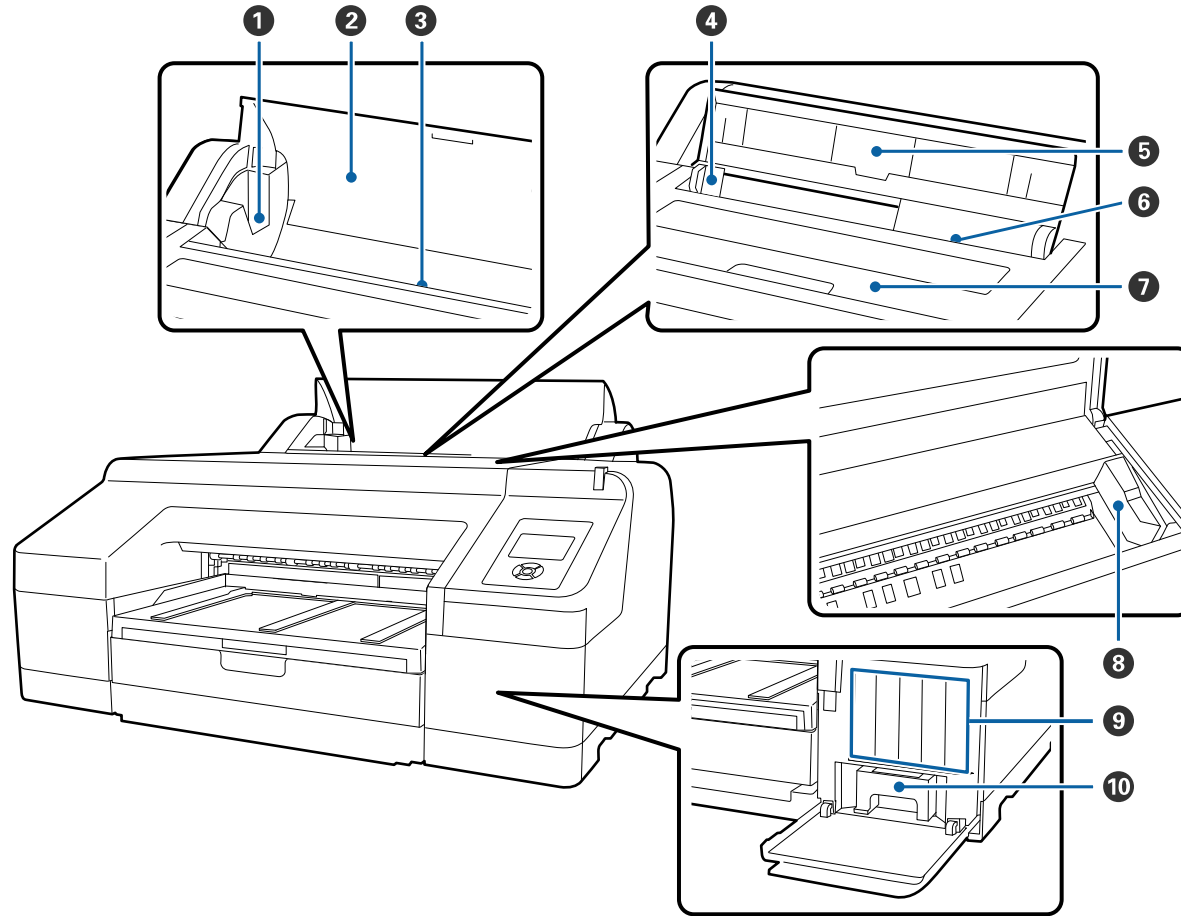

- 1 Roll paper spindle holders
- 2 Roll paper cover
- 3 Roll paper feeder
- 4 Edge guide
- 5 Paper support

- 6 Rear manual feeder
- 7 Printer cover
- 8 Print head
- 9 Ink cartridges
- 10 Ink maintenance tank (maintenance box 1)

Parent topic: [Printer Part Locations](#)

Product Parts - Rear/Spindle

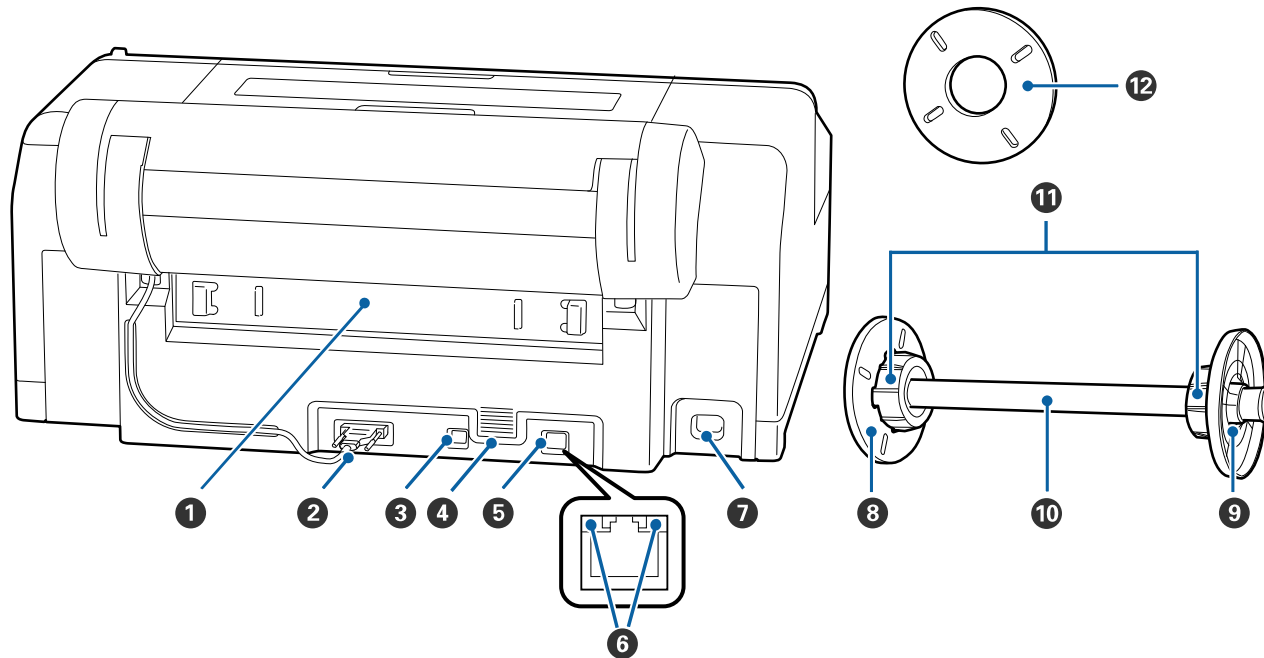









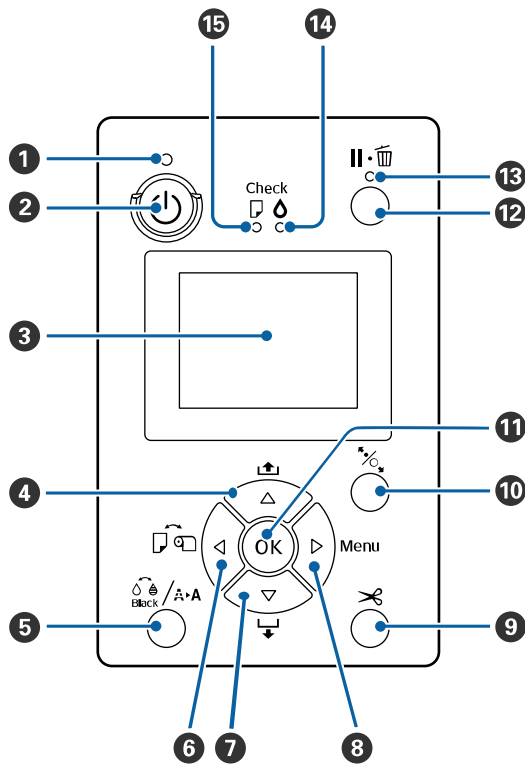



- 1 Rear access unit
- 2 Roll paper holder unit connector
- 3 USB port
- 4 Airflow vents

- 5 Ethernet/LAN port
- 6 Status lights
- 7 AC inlet
- 8 Removable paper stop (black)
- 9 Removable paper stop (gray)
- 10 Spindle
- 11 3-inch core adapters
- 12 Borderless printing spacer

Parent topic: [Printer Part Locations](#)

Control Panel Parts



- 1  power light
- 2  power button
- 3 LCD screen
- 4  paper feed and up arrow button
- 5  **Black** ink/maintenance button
- 6  paper source and left arrow button
- 7  paper feed and down arrow button
- 8 **Menu** and right arrow button
- 9  paper cut button
- 10  load paper button
- 11 **OK** button
- 12  pause/cancel button
- 13  pause/cancel light
- 14  **Check** ink light
- 15  **Check** paper light

LCD Screen Display

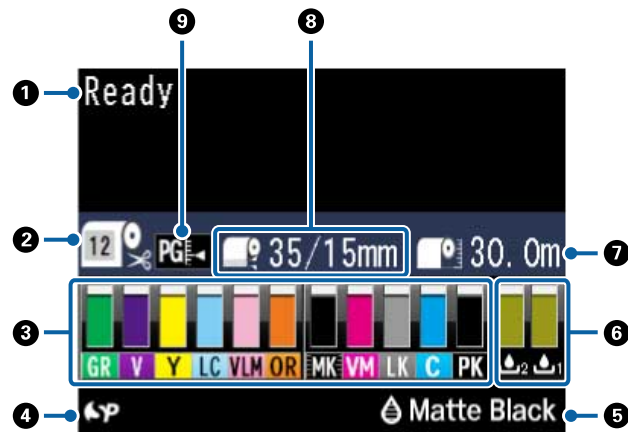

1 Status messages

2 Paper source

The icon indicates the current paper source settings. The number appears when a **Custom Paper** setting is selected.

: Roll paper with Auto Cut enabled

: Roll paper with Auto Cut disabled

: Cut sheet paper

3 Ink cartridge status

: Amount of ink remaining in the cartridge

: Ink level is low

: Ink cartridge is expended

: Ink error; check the status message on the LCD screen

4 : Installed options: SpectroProofer (shown) is the only supported option

5 Photo Black or Matte Black ink selected

Press the  **Black** ink/maintenance button to switch cartridge types

6 Maintenance tank status

: Amount of space remaining in the maintenance tank

: Maintenance tank is nearing the end of its service life

: Maintenance tank is at the end of its service life

7 Roll paper remaining

8 Roll paper margin setting

9 Platen gap setting

: **Narrow**

: **Standard**

: **Wide**

: **Wider**

: **Widest**

Parent topic: [Printer Part Locations](#)

Media Handling

See these sections to load and handle media on your product.

[Roll Paper Handling](#)

[Cut Sheet Handling](#)

[Creating Custom Paper Configurations](#)

[Available Epson Papers](#)

[Borderless Paper Type Compatibility](#)

Roll Paper Handling

See these sections to load, cut, and remove roll paper in your product.

[Removing the Roll Media Adapter - 2-inch Core](#)

[Installing the Roll Media Adapter - 3-inch Core](#)

[Loading Roll Paper on the Spindle](#)

[Installing the Borderless Spacer](#)

[Loading Roll Paper](#)

[Cutting Roll Paper](#)

[Removing Roll Paper](#)

Parent topic: [Media Handling](#)

Removing the Roll Media Adapter - 2-inch Core

For roll canvas media with a 2-inch core, you need to remove the roll media adapter from the paper stop to match the core size of your roll canvas media.

Note: Thin media (less than 250 gsm) is not supported for this core size.

1. Remove the black paper stop from the spindle.

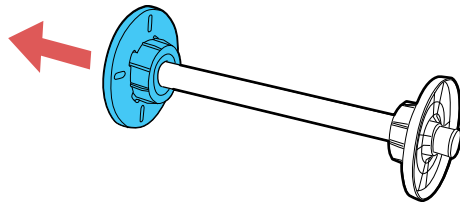

2. Push out the two hooks on the black paper stop and remove the gray adapter from the paper stop.

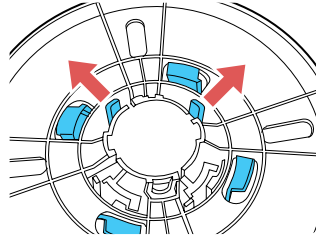

3. To remove the gray adapter from the other paper stop, slide it off the spindle.

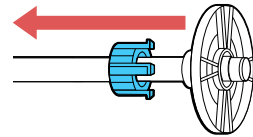

Parent topic: [Roll Paper Handling](#)

Installing the Roll Media Adapter - 3-inch Core

For roll paper with a 3-inch core, you need to install the roll media adapter onto the paper stop to match the core size of your roll paper.

1. Remove the black paper stop from the spindle.

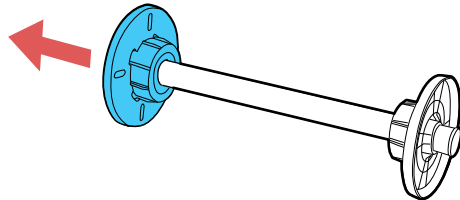

2. Align the triangles on the gray adapter with the triangles on the paper stop and press until the hooks click into place.

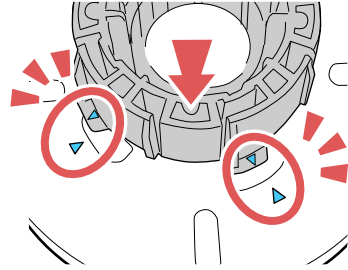

3. Insert the other gray adapter onto the spindle and attach it to the other paper stop.

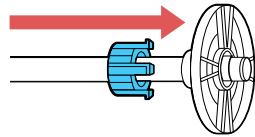

Parent topic: [Roll Paper Handling](#)

Loading Roll Paper on the Spindle

Load roll canvas media on the spindle included with the roll paper unit.

1. Remove any tape and protective paper from the end of the roll. Make sure the paper is cut straight across to avoid paper feeding problems.

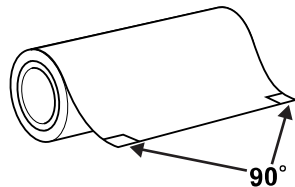

Note: Avoid touching the surface of your paper or resting it on a dusty area. With canvas media that you have previously loaded, it's a good idea to cut the edge straight each time you reload it.

2. Remove the black paper stop from the spindle.

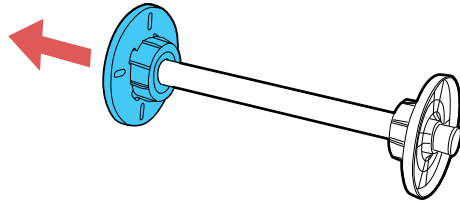

3. Insert the spindle into the roll paper core so that the end of the roll paper is facing towards you.

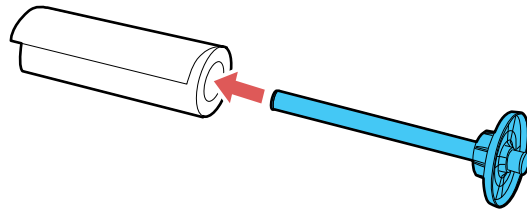

4. Press the roll paper against the fixed paper stop until that there is no gap between the paper stop and the roll paper.

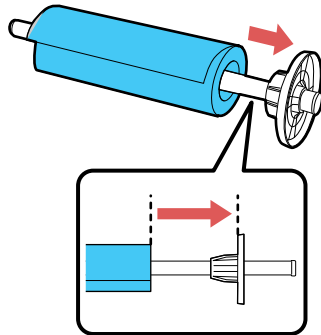

5. Insert the black paper stop onto the spindle and press in until there is no gap between the paper stop and the roll paper.

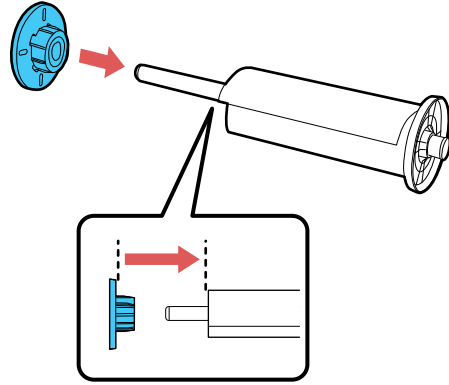

Parent topic: [Roll Paper Handling](#)

Installing the Borderless Spacer

When you perform borderless printing on roll paper, you may need to install the borderless spacer.

Note: Only 2-inch core media is supported when using the borderless spacer.

1. Remove the black paper stop from the spindle.

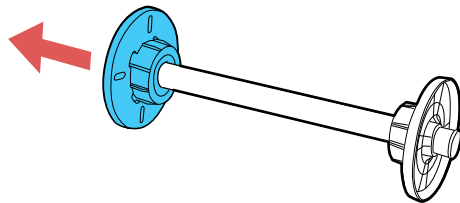

2. Slide the spacer all the way onto the spindle until it reaches the gray paper stop on the other end. Make sure the holes in the spacer and paper stop line up exactly.

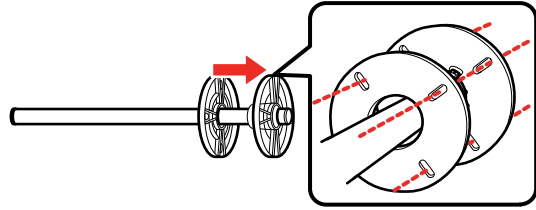

Parent topic: [Roll Paper Handling](#)

Related references

[Borderless Paper Type Compatibility](#)

Loading Roll Paper

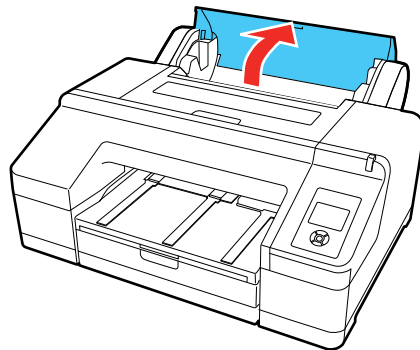

You can load roll paper with a 2- or 3-inch core and a width of up to 17 inches (43 cm).

1. Make sure the printer is turned on.
2. On the control panel, press the  paper source button.
3. Press the down arrow button to select **Roll Paper/Cut** or **Roll Paper/No Cut**, and press the **OK** button.
4. Open the roll paper cover.

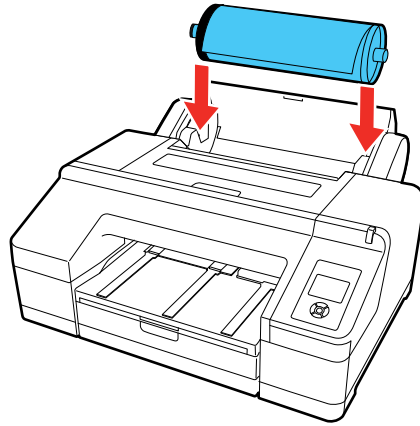

5. Place the roll paper in the printer as shown (the black end of the spindle goes on the left).



6. Press the , load paper button on the control panel.
7. Insert the leading edge of the roll paper into the rear manual paper feeder until a message on the LCD screen tells you to press the , load paper button.

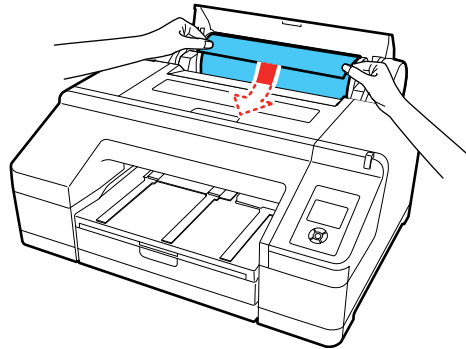

8. Press the , load paper button on the control panel. The printer automatically feeds the paper to the printing position.

9. Close the roll paper cover.

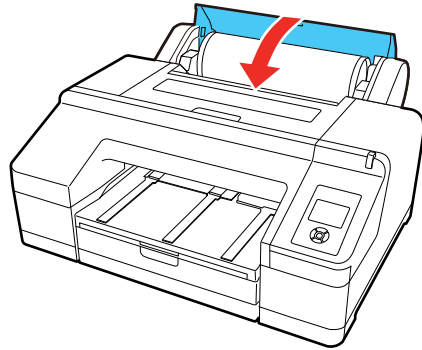

Note: To prevent dust from accumulating inside the printer, always keep the roll paper cover closed unless you are loading or unloading media.

10. On the screen that appears, select one of the following settings:

- If the paper settings are correct, select **Yes**.
- If you want to change the paper settings, select **No** so you can adjust the settings.

11. Press the **OK** button.

12. Slide out the output tray. Do not raise the paper stopper or the roll paper may not eject correctly.

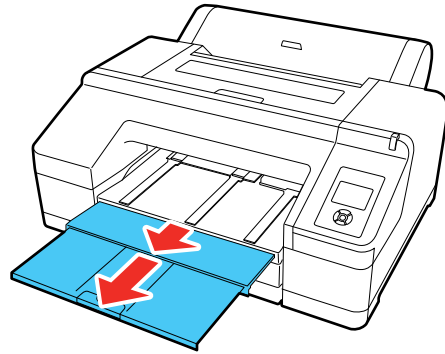

Note: If you are printing on plain paper or thin media types, or if you are using the optional Spectroproofer, raise the paper eject support. This prevents paper from curling up in the output tray, which can cause paper jams and print head strikes.

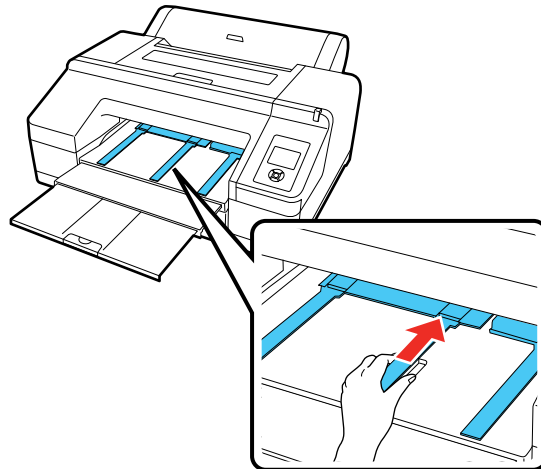

Parent topic: [Roll Paper Handling](#)

Related references

[Available Epson Papers](#)

[Roll Paper Options - Windows](#)

[Paper Specifications](#)

Related tasks

[Removing Roll Paper](#)

[Selecting Roll Paper Settings - Mac](#)

Cutting Roll Paper

The printer has a built-in cutter that can automatically cut most paper types, or you can cut your prints manually. To switch between cutting methods, press the  paper source button on the control panel or adjust the auto cut settings in the printer driver. The setting selected in the printer driver overrides the control panel setting.

Caution: Use of the built-in cutter is not recommended for the below paper types, as it may lead to dulling of the blade and more frequent replacement:

- Fine art paper
- Canvas

Caution: Do not use the built-in cutter with these paper types or you may damage or dull the built-in cutter:

- Vinyl
- Matte poster board
- Adhesive paper
- Banner media

When you print on these paper types, you need to disable the Auto Cut setting and cut the print off the roll manually.

[Cutting Roll Paper Manually](#)

[Printing Trim Lines](#)

Parent topic: [Roll Paper Handling](#)

Related references

[Roll Paper Options - Windows](#)



Related tasks

[Selecting Roll Paper Settings - Mac](#)

Cutting Roll Paper Manually

You can keep your prints on the roll until you manually cut them.

Note: The built-in cutter may not be able to cut some types of media. In addition, heavy or thick media types may damage or dull the cutter, requiring more frequent replacement.

1. Press the  paper source button.
2. Press the down arrow button to select **Roll Paper/No Cut**, and press the **OK** button.
3. Run your print job.
4. Press the  paper cut button.

Note: If the paper cannot be cut by the built-in cutter, press the  paper feed button until your print is clear of the printer, then cut the print by hand.

Parent topic: [Cutting Roll Paper](#)

Printing Trim Lines

When you disable the Auto Cut setting, you can print a trim line (page line) between print jobs as a guide for manual cutting.

1. Before you print, press the **Menu** button.
2. Press the down arrow button to select **Paper** and press the right arrow button.
3. Select **Roll Paper Setup** and press the right arrow button.
4. Select **Print Page Line** and press the right arrow button.
5. Press the up or down arrow button to select **On**.
6. Press the **OK** button to save the setting.
A check mark appears next to the setting.
7. Press the  pause/cancel button to exit the menu.
8. Run your print job.

Parent topic: [Cutting Roll Paper](#)

Related references

[Paper Menu Settings](#)

Removing Roll Paper

When you finish printing on roll paper, you should remove it from the printer to avoid indenting or creasing the paper.

1. Open the roll paper cover.

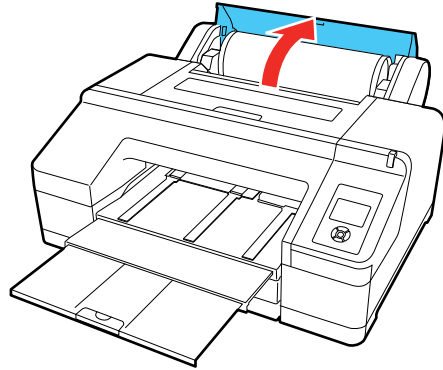

2. Press the  load paper button to release the paper. The paper rewinds automatically.

Note: Make sure the roll paper is rewound completely before removing it from the printer.

3. Hold both ends of the spindle and lift it up from the spindle holder.

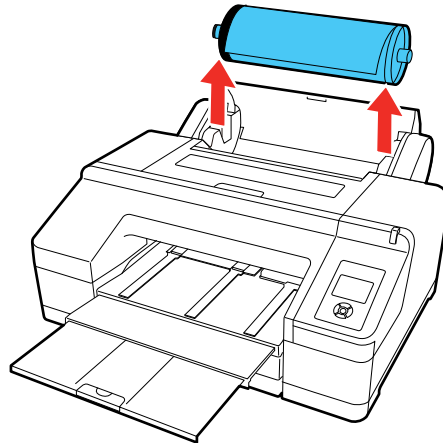

4. Remove the black paper stop from the spindle as shown.

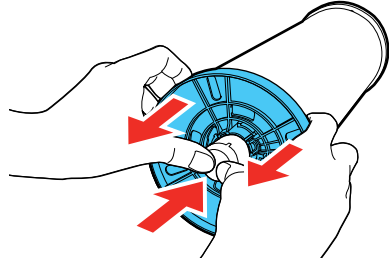

5. Remove the roll paper from the spindle.

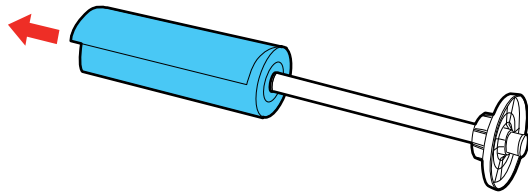

6. Place the roll paper in its original package.

Note: Store roll paper on its end or horizontally (if the packaging end-caps are installed). Never store roll paper on its edge, as a flat spot can develop and lead to imaging artifacts on the prints.

Note: Do not store roll paper in dusty areas. Print head maintenance and cleanings increase if dust accumulates on the paper.

7. Close the roll paper cover.

Note: To prevent dust from accumulating inside the printer, always keep the roll paper cover closed unless you are loading or unloading media.

Parent topic: [Roll Paper Handling](#)

Cut Sheet Handling

You can load a variety of types and sizes of cut sheet paper in your product.

[Loading Cut Sheets in the Paper Cassette](#)
[Loading Cut Sheets in the Rear Manual Feeder](#)
[Loading Cut Sheets in the Front Manual Feeder](#)
[Adjusting the Platen Gap](#)

Parent topic: [Media Handling](#)

Loading Cut Sheets in the Paper Cassette

You can print on a variety of paper types and sizes up to 17 inches (43 cm) wide and 0.1 inch (0.27 mm) thick from the paper cassette.

1. Make sure the printer is turned on.
2. On the control panel, press the  paper source button.
3. Press the down arrow button to select **Cut Sheet**, and press the **OK** button.
4. Lift the edge of the output tray to remove it.

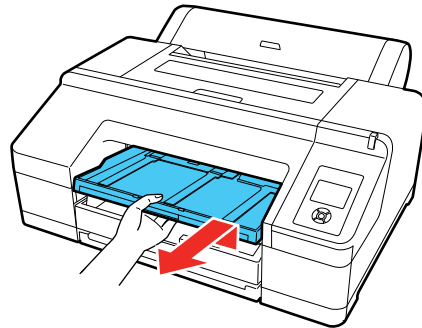

5. Slide out the paper cassette, then pull it all the way out.

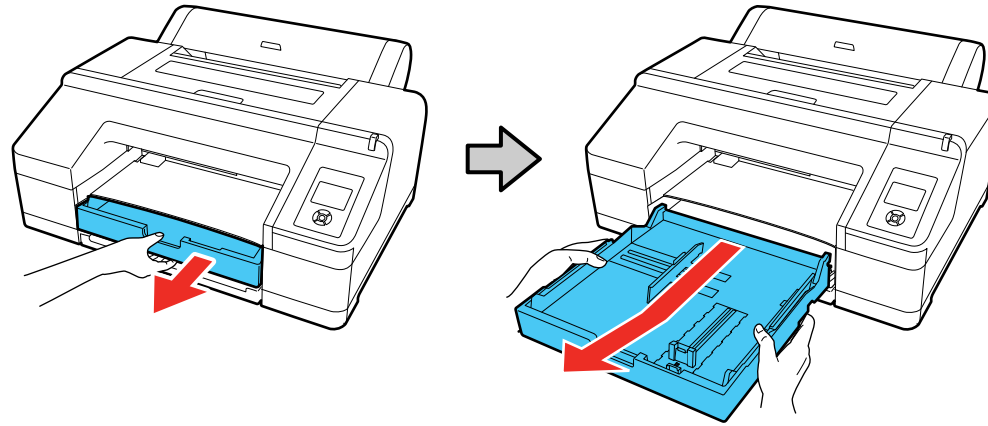

Note: If you are loading paper that is 13 × 19 inches (330 × 483 mm) or larger, pull the lever in the paper cassette to extend it as far as possible and expand the slider all the way to the edge of the paper cassette.

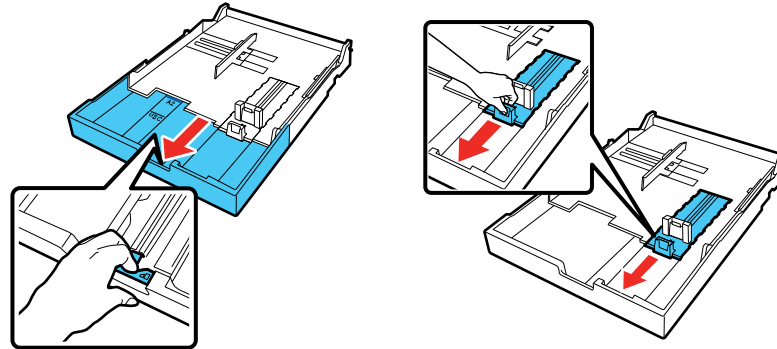

6. Slide the edge guides outward.

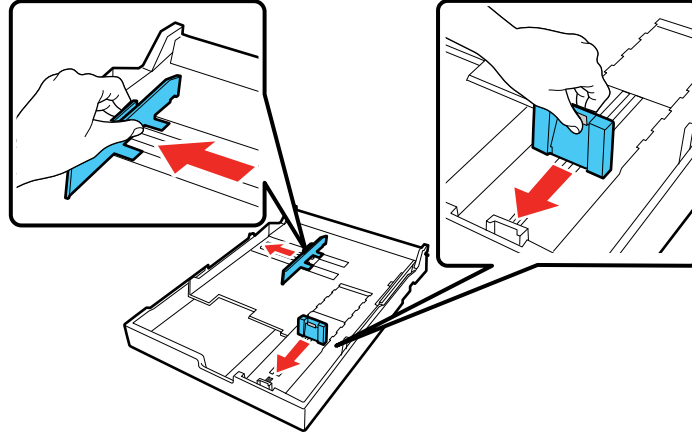

7. Fan through a stack of paper, then gently tap it on a flat surface to even the edges.



8. Load the paper with the printable side facedown and short edge first. Place the paper all the way back in the paper cassette and next to the right edge. Make sure the paper fits under the arrow on the left edge guide.

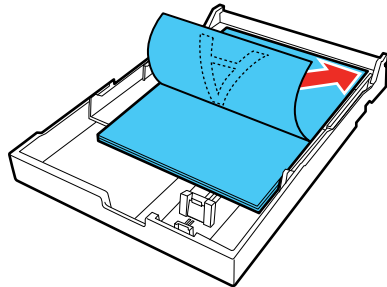

9. Slide the edge guides against the paper, but not too tightly.

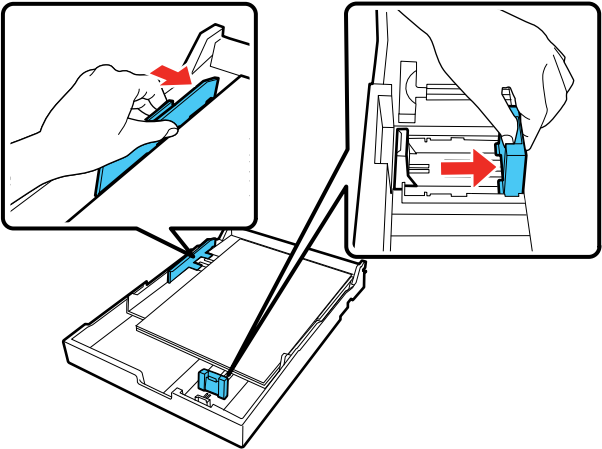

10. Insert the paper cassette and push it firmly into the printer.

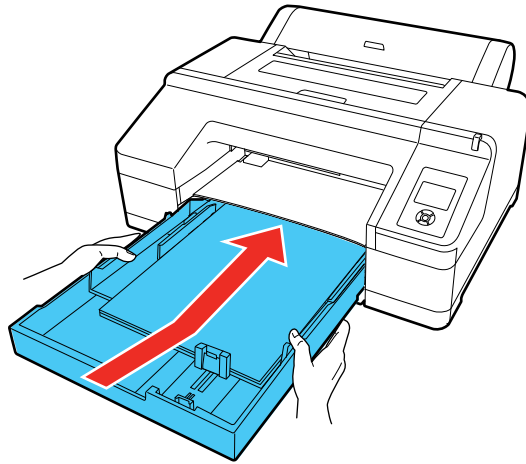

Note: If you loaded paper that is 13 × 19 inches (330 × 483 mm) or larger, install the paper cassette cover, aligning the arrows as shown. This cover is important to limit dust from accumulating on cut sheets in the paper cassette and will help reduce print head maintenance and cleanings.

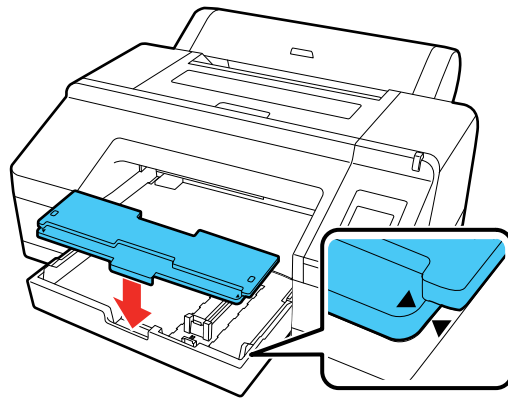

11. Replace the output tray.

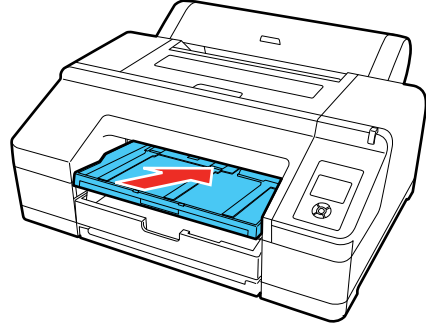

12. Adjust the output tray to fit your paper size.

A4 paper: Slide out the third extension, raise the paper stopper, and push the extension back in.

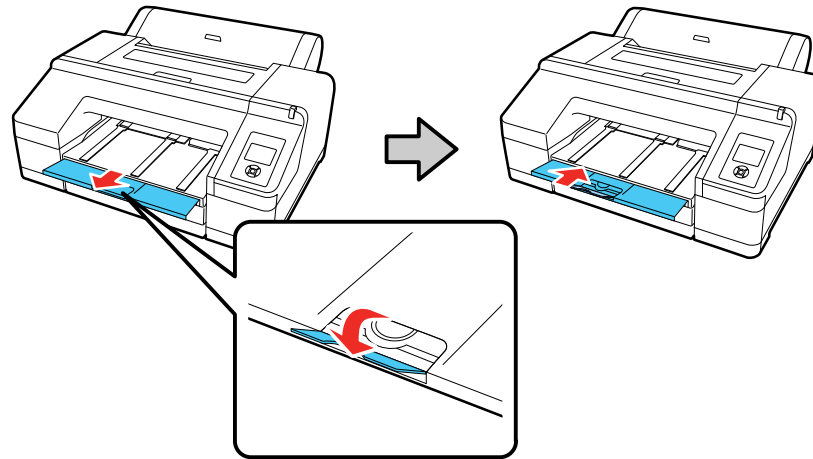

A3 paper: Pull out the third extension and raise the paper stopper.

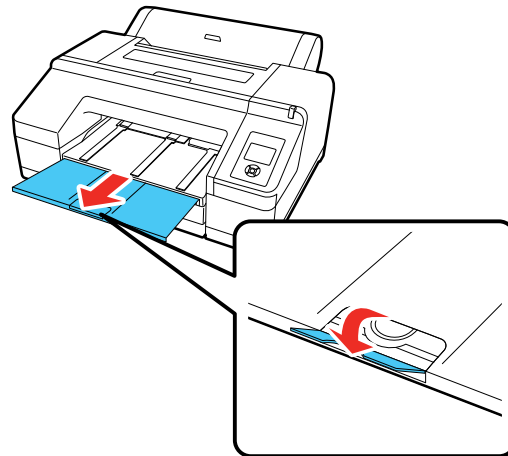

Super A3 or larger paper: Pull out the second and third extensions and raise the paper stopper.

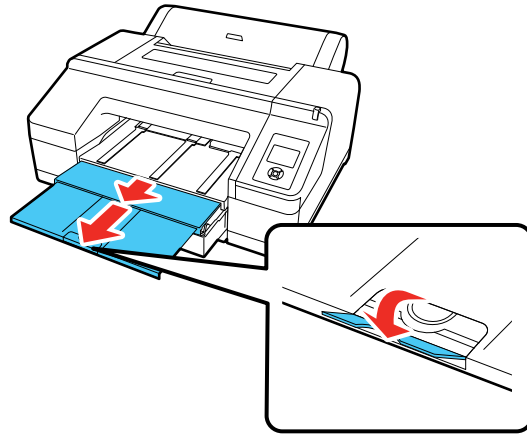

Parent topic: [Cut Sheet Handling](#)

Related references

[Available Epson Papers](#)

[Paper Specifications](#)

Loading Cut Sheets in the Rear Manual Feeder

Use the rear manual feeder to load one cut sheet at a time up to 0.3 inch (0.79 mm) thick.

1. Make sure the printer is turned on.
2. On the control panel, press the  paper source button.
3. Press the down arrow button to select **Cut Sheet**, and press the **OK** button.

4. Open and extend the paper support.

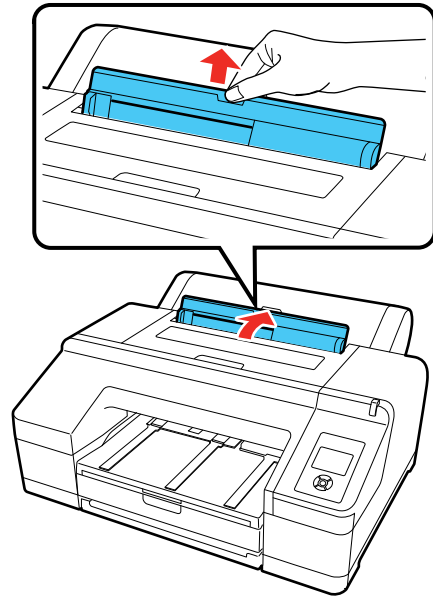

5. Adjust the edge guide to fit the paper width.

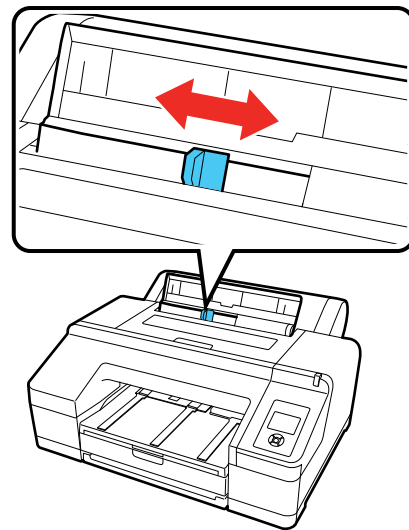

6. Insert a single cut sheet into the rear manual feeder, printable side up, until it reaches the gray rollers inside the printer.

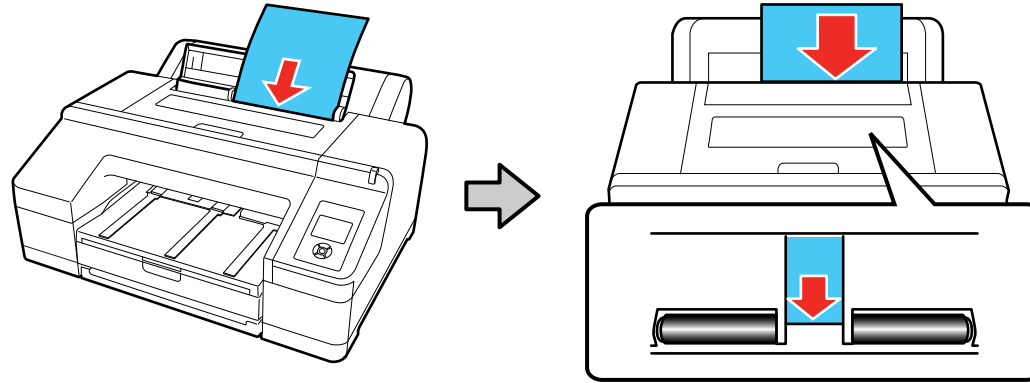

7. Extend the output tray as necessary to support the sheet as it comes out of the printer.

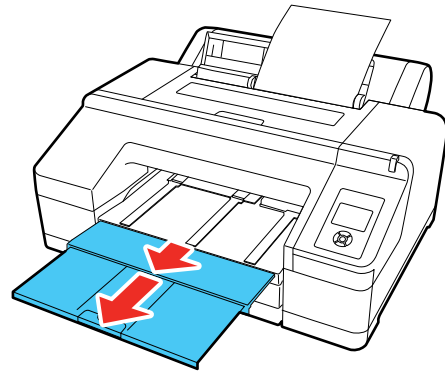

8. Press the  paper feed button on the control panel to feed the paper through the printer.

Parent topic: [Cut Sheet Handling](#)



Related references

[Available Epson Papers](#)

[Paper Specifications](#)

Loading Cut Sheets in the Front Manual Feeder

Use the front manual feeder to load one cut sheet at a time up to 0.06 inch (1.5 mm) thick.

1. Make sure the printer is turned on.
2. On the control panel, press the  paper source button.
3. Press the down arrow button to select **Cut Sheet**, and press the **OK** button.
4. Press the , load paper button to release the pressure roller.
5. Insert paper with the printable side up over the black roller in the front manual feeder as shown.

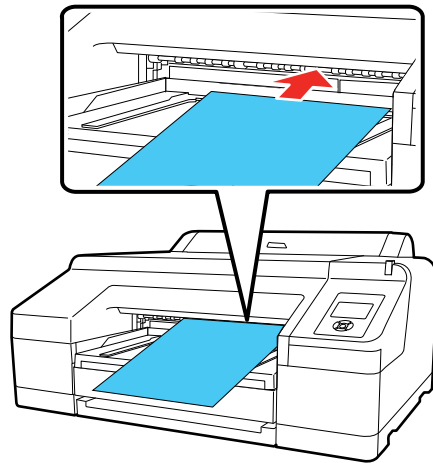

6. Look through the printer window and make sure the paper is inserted under the gray roller inside the printer.

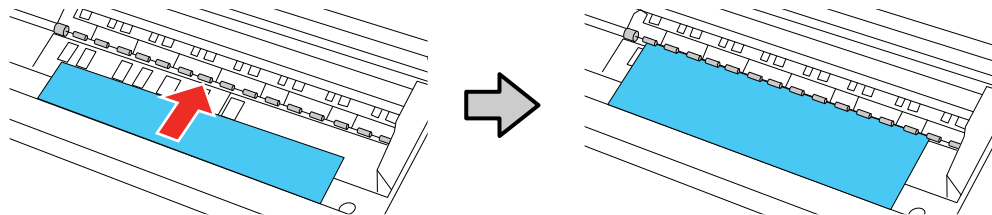

7. Align the edge of the paper with the guide line on the output tray.

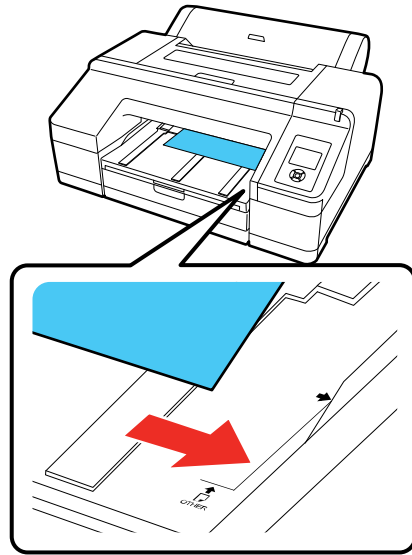

8. Press the , load paper button to feed the paper through the printer.
9. Extend the output tray to support the paper as it comes out of the printer. Do not raise the paper stopper or paper may be ejected incorrectly.

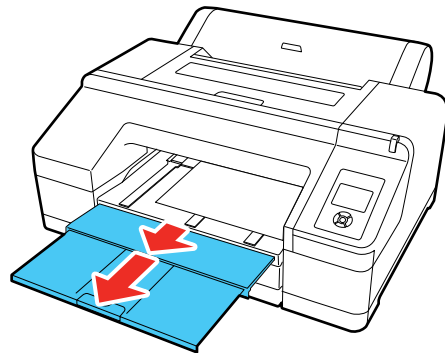

10. When printing is finished, press the $\frac{1}{2}$ load paper button to release the pressure roller so you can pull out the paper.

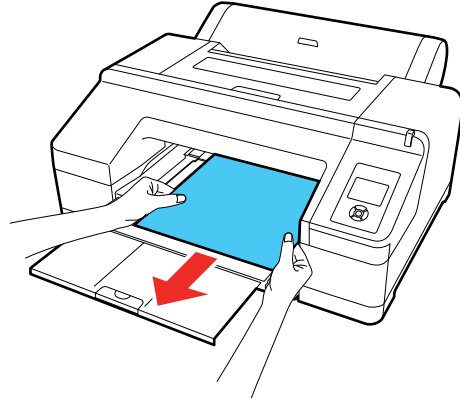

Parent topic: [Cut Sheet Handling](#)

Related references

[Available Epson Papers](#)

[Paper Specifications](#)

Adjusting the Platen Gap

If the print quality is not satisfactory when printing on very thin or very thick media, you may need to adjust the Platen Gap setting to adjust the gap between the media and the print head. Use the widest gap that maintains high quality printing. Selecting a narrower than required gap can lead to increased print head maintenance and cleanings.

Note: If you notice scuffs on the first few inches of your prints, this is caused by paper curl and print head strikes. Make sure your paper is flat. You can also try changing the Platen Gap setting to **Wide**. If that doesn't solve the problem, try changing it to **Wider**.

1. Press the **Menu** button.
2. Press the down arrow button to select **Printer Setup** and press the right arrow button.
3. Press the right arrow button to select **Platen Gap**.

4. Press the up or down arrow to select a platen gap setting and press the **OK** button.

Note: To avoid damaging the printer, do not select the **Narrow** setting when loading thick media.

A check mark appears next to the selected setting.

5. Press the **II**  pause/cancel button to exit the menu.

The platen gap symbol on the LCD screen changes to match the new setting.

Parent topic: [Cut Sheet Handling](#)

Related references

[Printer Setup Menu Settings](#)

Creating Custom Paper Configurations

You can create and store up to 10 custom paper configurations for use in printing on non-Epson paper or paper that is not supported by the Epson printer driver.

Note: Custom paper configurations are based on the existing Uni-D and Bi-D print head alignment. For best results, perform the print head alignment using Epson Doubleweight Matte Paper, Epson Enhanced Matte Paper, or Epson Ultra Premium Photo Paper Luster.

1. Load the type of paper that you want to configure in the printer.
2. Press the **Menu** button.
3. Press the up or down arrow button to select **Paper** and press the right arrow button.
4. Select **Custom Paper** and press the right arrow button.
5. Select a number for the custom paper configuration and press the right arrow button.
6. Select **Select Reference Paper** and press the right arrow button.
7. Select a paper preset that is similar to the paper that you loaded and press the right arrow button.

Note: Use the following guidelines when selecting the reference paper that is closest to the paper you are using:

- Glossy paper: **Photo Paper** or **Proofing Paper**
- Thick paper that is not glossy: **Matte Paper**
- Thin, soft paper that is not glossy: **Plain Paper**

- Cotton paper with a rough surface: **Fine Art Paper**
 - Special media such as film, cloth, poster board, or tracing paper: **Others**
8. Press the left arrow button to return to the **Custom Paper** menu.
 9. Select **Platen Gap** and press the right arrow button.
 10. Select a platen gap setting and press the **OK** button.
 11. Press the left arrow button to return to the **Custom Paper** menu.
 12. Select **Thickness Pattern** and press the right arrow button.
 13. Press the **OK** button.
A paper thickness pattern prints.
 14. Check the printed pattern and locate the pattern with the most evenly overlapping lines.

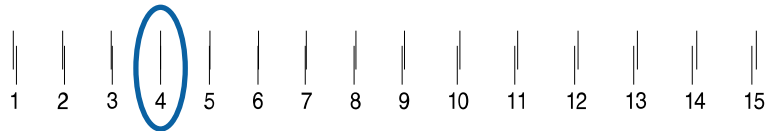

Note: It is normal for two patterns to look very similar. Select the most acceptable pattern.

15. Select the number of the most even pattern and press the **OK** button.
16. Select any additional settings in the Custom Paper Settings menu, as necessary.
17. When you finish changing the custom paper configuration settings, press **II** •  pause/cancel to exit the menu.

After you create custom paper configurations, you can print a list of the presets and the settings for each one.

Note: You can also use the LFP Remote Panel Utility software to create custom paper configurations.

[Printing a Custom Paper Configuration List](#)
[Selecting Custom Paper Configurations](#)

Parent topic: [Media Handling](#)

Related references

[Paper Menu Settings](#)

Printing a Custom Paper Configuration List

You can print a list of the settings for all the custom paper configurations that you have created.

1. Press the **Menu** button.
2. Press the down arrow button to select **Paper** and press the right arrow button.
3. Select **Print Paper List** and press the right arrow button.
4. Press the **OK** button to print the list of your custom paper configurations.

Parent topic: [Creating Custom Paper Configurations](#)

Related references

[Paper Menu Settings](#)

Selecting Custom Paper Configurations

Once you have created a custom paper configuration, you can select the configuration whenever you print on the associated media.

1. Press the **Menu** button.
2. Press the up or down arrow button to select **Paper** and press the right arrow button.
3. Select **Paper Type** and press the right arrow button.
4. Select **Custom Paper** and press the right arrow button.
5. Select the custom paper configuration you want to use and press the **OK** button.
6. Press the **II**  pause/cancel button to exit the menu.

The custom paper configuration you selected is displayed on the LCD screen.

Parent topic: [Creating Custom Paper Configurations](#)

Related references

[Paper Menu Settings](#)

Available Epson Papers

You can purchase genuine Epson ink, paper, and accessories from an Epson authorized reseller. To find the nearest reseller, visit proimaging.epson.com (U.S.) or proimaging.epson.ca (Canada), select

your product series and product, and click the **Where to Buy** button. Or call 800-GO-EPSON (800-463-7766) in the U.S. or 800-807-7766 in Canada.

Note: Paper/media availability varies by country.

Paper Type	Size	Part number	Sheet count
Epson Legacy Platine	Letter (8.5 × 11 inches [216 × 279 mm])	S450079	25
	13 × 19 inches (330 × 483 mm)	S450080	25
	17 × 22 inches (432 × 559 mm)	S450081	25
	17 inches (432 mm) × 50 feet (15.2 m)	S450076	1 roll
Epson Legacy Fibre	Letter (8.5 × 11 inches [216 × 279 mm])	S450085	25
	13 × 19 inches (330 × 483 mm)	S450086	25
	17 × 22 inches (432 × 559 mm)	S450087	25
	17 inches (432 mm) × 50 feet (15.2 m)	S450082	1 roll
Epson Legacy Etching	Letter (8.5 × 11 inches [216 × 279 mm])	S450091	25
	13 × 19 inches (330 × 483 mm)	S450092	25
	17 × 22 inches (432 × 559 mm)	S450093	25
	17 inches (432 mm) × 50 feet (15.2 m)	S450088	1 roll
Epson Legacy Baryta	Letter (8.5 × 11 inches [216 × 279 mm])	S450097	25
	13 × 19 inches (330 × 483 mm)	S450098	25
	17 × 22 inches (432 × 559 mm)	S450099	25
	17 inches (432 mm) × 50 feet (15.2 m)	S450094	1 roll

Paper Type	Size	Part number	Sheet count
Epson Cold Press Bright	Letter (8.5 × 11 inches [216 × 279 mm])	S042307	25
	13 × 19 inches (330 × 483 mm)	S042310	25
	17 × 22 inches (432 × 559 mm)	S042311	25
Epson Cold Press Natural	Letter (8.5 × 11 inches [216 × 279 mm])	S042297	25
	13 × 19 inches (330 × 483 mm)	S042300	25
	17 × 22 inches (432 × 559 mm)	S042301	25
Epson Velvet Fine Art Paper	Letter (8.5 × 11 inches [216 × 279 mm])	S041636	20
	13 × 19 inches (330 × 483 mm)	S041637	20
	17 × 22 inches (432 × 559 mm)	S042097	25
Epson Exhibition Fiber Paper	Letter (8.5 × 11 inches [216 × 279 mm])	S045033	25
	13 × 19 inches (330 × 483 mm)	S045037	25
	17 × 22 inches (432 × 559 mm)	S045039	25
Epson Hot Press Bright	Letter (8.5 × 11 inches [216 × 279 mm])	S042327	25
	13 × 19 inches (330 × 483 mm)	S042330	25
	17 × 22 inches (432 × 559 mm)	S042331	25
Epson Hot Press Natural	Letter (8.5 × 11 inches [216 × 279 mm])	S042317	25
	13 × 19 inches (330 × 483 mm)	S042320	25
	17 × 22 inches (432 × 559 mm)	S042321	25
Epson Exhibition Watercolor Paper Textured	Letter (8.5 × 11 inches [216 × 279 mm])	S045486	25
	13 × 19 inches (330 × 483 mm)	S045487	20
	17 × 22 inches (432 × 559 mm)	S045488	25

Paper Type	Size	Part number	Sheet count
Epson Ultra Premium Photo Paper Glossy	Letter (8.5 × 11 inches [216 × 279 mm])	S042175	20
	8 × 10 inches (203 × 254 mm)	S041946	20
Epson Premium Luster Photo Paper (260)	8.3 inches (211 mm) × 32 feet (9.8 m)	S041408	1 roll
	13 inches (330 mm) × 32 feet (9.8 m)	S041409	1 roll
	10 inches (254 mm) × 100 feet (30.5 m)	S042077	1 roll
	16 inches (406 mm) × 100 feet (30.5 m)	S042079	1 roll
Epson Metallic Photo Paper Glossy	Letter (8.5 × 11 inches [216 × 279 mm])	S045589	25
	13 × 19 inches (330 × 483 mm)	S045590	25
	17 × 22 inches (432 × 559 mm)	S045591	25
Epson Metallic Photo Paper Luster	Letter (8.5 × 11 inches [216 × 279 mm])	S045516	25
	13 × 19 inches (330 × 483 mm)	S045517	25
	17 × 22 inches (432 × 559 mm)	S045598	25
Epson Photo Paper Glossy	Letter (8.5 × 11 inches [216 × 279 mm])	S041649	50
	11 × 17 inches (279 × 432 mm)	S041156	20
	13 × 19 inches (330 × 483 mm)	S041143	20
	Letter (8.5 × 11 inches [216 × 279 mm])	S041271	100

Paper Type	Size	Part number	Sheet count
Epson Premium Photo Paper Glossy	Letter (8.5 × 11 inches [216 × 279 mm])	S041286	20
	A3 (11.7 × 16.5 inches [297 × 420 mm])	S041288	20
	13 × 19 inches (330 × 483 mm)	S041289	20
	Letter (8.5 × 11 inches [216 × 279 mm])	S041667	50
	11 × 17 inches (279 × 432 mm)	S041290	20
	8 × 10 inches (203 × 254 mm)	S041465	20
	11 × 14 inches (279 × 356 mm)	S041466	20
	17 × 22 inches (432 × 559 mm)	S042092	25
Epson Premium Photo Paper Semi-gloss	Letter (8.5 × 11 inches [216 × 279 mm])	S041331	20
	13 × 19 inches (330 × 483 mm)	S041327	20
	8 × 10 inches (203 × 254 mm)	S041467	50
	Letter (8.5 × 11 inches [216 × 279 mm])	S041257	50
	11 × 14 inches (279 × 356 mm)	S041468	50
	A3 (11.7 × 16.5 inches [297 × 420 mm])	S041260	50
	13 × 19 inches (330 × 483 mm)	S041263	50
	17 × 22 inches (432 × 559 mm)	S042124	25

Paper Type	Size	Part number	Sheet count
Epson Premium Presentation Paper Matte	Letter (8.5 × 11 inches [216 × 279 mm])	S041062	100
	Legal (8.5 × 14 inches [216 × 356 mm])	S041067	100
	11 × 17 inches (279 × 432 mm)	S041070	100
	13 × 19 inches (330 × 483 mm)	S041069	100
	16.5 × 23.4 inches (420 × 594 mm)	S041079	30
	17 × 22 inches (432 × 559 mm)	S041171	100
Epson Proofing Paper White Semimatte	13 × 19 inches (330 × 483 mm)	S045115	100
	13 inches (300 mm) × 100 feet (30.5 m)	S042002	1 roll
	17 inches (432 mm) × 100 feet (30.5 m)	S042003	1 roll
Epson Standard Proofing Paper Publication	13 inches (300 mm) × 100 feet (30.5 m)	S041996	1 roll
	17 inches (432 mm) × 100 feet (30.5 m)	S041997	1 roll
Epson Standard Proofing Paper Commercial	13 inches (300 mm) × 100 feet (30.5 m)	S042144	1 roll
	17 inches (432 mm) × 100 feet (30.5 m)	S041997	1 roll
Epson Standard Proofing Paper (240)	13 × 19 inches (330 × 483 mm)	S045115	100

Paper Type	Size	Part number	Sheet count
Epson Ultra Premium Photo Paper Luster	Letter (8.5 × 11 inches [216 × 279 mm])	S041405	50
	A3 (11.7 × 16.5 inches [297 × 420 mm])	S041406	50
	13 × 19 inches (330 × 483 mm)	S041407	50
	13 × 19 inches (330 × 483 mm)	S041604	100
	17 × 22 inches (432 × 559 mm)	S042084	25
	13 inches (330 mm) × 32.8 feet (10 m)	S041409	1 roll
Epson Ultra Premium Presentation Paper Matte	Letter (8.5 × 11 inches [216 × 279 mm])	S041341	50
	A3 (11.7 × 16.5 inches [297 × 420 mm])	S041343	50
	13 × 19 inches (330 × 483 mm)	S041339	50
	13 × 19 inches (330 × 483 mm)	S041605	100
	17 × 22 inches (432 × 559 mm)	S041908	100
Epson UltraSmooth Fine Art Paper	13 × 19 inches (330 × 483 mm)	S041896	25
	17 × 22 inches (432 × 559 mm)	S041897	25
Epson Watercolor Paper Radiant White	13 × 19 inches (330 × 483 mm)	S041351	20
Epson Exhibition Canvas Matte	13 inches (330 mm) × 20 feet (6.1 m)	S045255	1 roll
	17 × 22 inches (432 × 559 mm)	S045255	25
Epson Exhibition Canvas Satin	13 inches (330 mm) × 20 feet (6.1 m)	S045248	1 roll
Epson Exhibition Canvas Gloss	13 inches (330 mm) × 20 feet (6.1 m)	S045241	1 roll
Epson Exhibition Canvas Natural Matte	13 inches (330 mm) × 20 feet (6.1 m)	S045241	1 roll

Paper Type	Size	Part number	Sheet count
Epson Exhibition Canvas Natural Satin	13 inches (330 mm) × 20 feet (6.1 m)	S045396	1 roll
Epson Exhibition Canvas Natural Gloss	13 inches (330 mm) × 20 feet (6.1 m)	S045410	1 roll
Epson Premium Glossy Photo Paper (250)	16 inches (406 mm) × 100 feet (30.5 m)	S041742	1 roll
Epson Premium Semimatte Photo Paper (250)	16 inches (406 mm) × 100 feet (30.5 m)	S042149	1 roll
Epson Premium Glossy Photo Paper (170)	16.5 inches (419 mm) × 100 feet (30.5 m)	S042076	1 roll
Epson Enhanced Matte Paper	16 inches (406 mm) × 100 feet (30.5 m)	S041725	1 roll
Epson Singleweight Matte Paper	17 inches (432 mm) × 132 feet (40.2 m)	S041746	1 roll
	17 inches (432 mm) × 132 feet (40.2 m)	S041853	1 roll

Parent topic: [Media Handling](#)

Borderless Paper Type Compatibility

You can print borderless photos on compatible paper types in compatible paper widths:

Examples of Borderless Paper Types

- Epson Singleweight Matte Paper
- Epson Doubleweight Matte Paper
- Epson Premium Glossy Photo Paper (250)
- Epson Premium Glossy Photo Paper (170)
- Epson Premium Semimatte Photo Paper (250)
- Epson Premium Luster Photo Paper (260)

Borderless Roll Paper Widths

- 10 inches (254 mm)
- 11.8 inches (300 mm)
- 13 inches (330 mm)
- 14 inches (356 mm)
- 16 inches (406 mm)
- 17 inches (432 mm)

Borderless Roll Paper Widths for 2-inch Core Media

(requires use of the borderless spacer)

- 8 inches (203 mm)
- 11 inches (280 mm)
- 16.5 inches (420 mm)

Note: The printer software allows you to create and select custom page sizes. To print borderless on roll media, make sure the standard or custom size uses a supported width or an error will occur on the printer.

Parent topic: [Media Handling](#)

Related references

[Printable Area Specifications](#)

[Roll Paper Options - Windows](#)

Related tasks

[Selecting Roll Paper Settings - Mac](#)

Printing from a Computer

Note: If you have an Internet connection, it is a good idea to check for updates to your product software on Epson's support website. If you see a Software Update screen, select **Enable automatic checking** and click **OK**. The update scans your system to see if you have the latest product software. Follow the on-screen instructions.

[Printing with Windows](#)

[Printing on a Mac](#)

Printing with Windows

You can print with your product using any Windows application, as described in these sections.

[Selecting Basic Print Settings - Windows](#)

[Selecting Print Layout Options - Windows](#)

[Selecting Additional Settings - Windows](#)

[Printing Your Document or Photo - Windows](#)

[Saving, Sharing, and Customizing the Printer Settings](#)

[Selecting Default Print Settings - Windows](#)

[Changing the Language of the Printer Software Screens](#)

[Changing Automatic Update Options](#)

Parent topic: [Printing from a Computer](#)

Selecting Basic Print Settings - Windows

Select the basic settings for the photo or document you want to print.

1. Open a photo or document for printing.
2. Select the print command in your application.

Note: You may need to select a print icon on your screen, the **Print** option in the File menu, or another command. See your application's help utility for details.

3. If necessary, select your product name as the printer you want to use.

Note: You may also need to select **Preferences**, **Properties**, **Print Settings**, or **Printer Properties** to view your print settings.

You see the Main tab of your printer settings window:

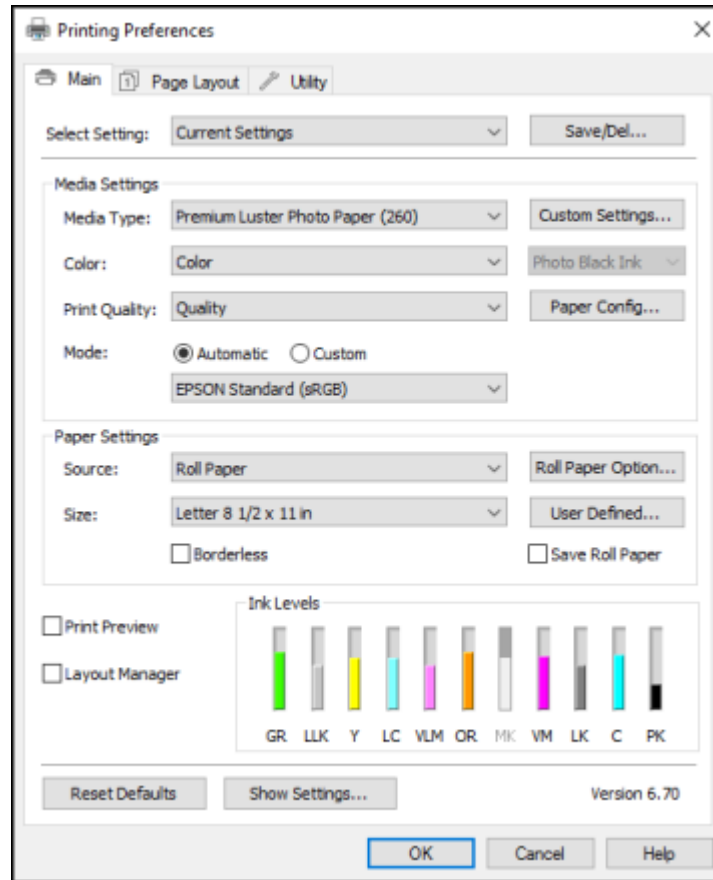

4. Select the **Media Type** setting that matches the paper you loaded.

Note: You can click **Custom Settings** to select a custom paper configuration.

5. If you are using non-Epson paper or media and you need to fine-tune its performance, select the **Media Type** setting that is closest to the paper you loaded, click the **Paper Config** button, and adjust the paper configuration options as necessary.
6. Select the **Photo Black Ink** or **Matte Black Ink** setting according to the media type you are using.

Note: If you set the **Auto Black Ink Change** option to **On** in the Printer Setup menu on the control panel, the black ink is automatically selected when you choose a media type.

7. Select a **Color** option:
 - To print a color document or photo, select the **Color** setting.
 - To print high quality black and white photos, select the **Advanced B&W Photo** setting.

Note: The **Advanced B&W Photo** setting is not available for Commercial Edition printers (configured with Violet ink).

 - To print text and graphics when plain paper is the selected media type, select the **Black** setting.
8. For the **Print Quality** setting, select **Speed**, **Quality**, or **Max Quality** (available with certain media types only), or select **Quality Options** and choose the quality option that matches the print quality you want to use.
9. Select the desired color management option as the **Mode** setting.
10. Select the **Source** setting that matches the paper feeding method you are using.
11. Select the size of the paper you loaded as the **Size** setting.

Note: You can also select the **User-Defined** setting to create a custom paper size.

12. If you are printing on roll paper, click the **Roll Paper Option** button and adjust the settings as necessary.
13. When Auto Cut is enabled, select the **Save Roll Paper** checkbox to have the printer cut the roll paper at the end of the image as it is positioned on the page.
14. If you want to print a photo without borders, select **Borderless**.

Note: You must select a compatible borderless paper type and size to print without borders. Check the borderless paper compatibility list for details.

15. To see a preview of how your document or photo will print, select **Print Preview**. (The preview appears after you click **Print** but before printing starts.)
16. To layout multiple print jobs for printing all at once, select **Layout Manager**.

[Paper Configuration Options - Windows](#)

[Advanced B&W Photo Options - Windows](#)

[Print Quality Options - Windows](#)

[Color Management Options - Windows](#)

[Advanced Color Controls - Windows](#)

[Paper Source Options - Windows](#)

[Roll Paper Options - Windows](#)

[Using Layout Manager - Windows](#)

Parent topic: [Printing with Windows](#)

Related references

[Borderless Paper Type Compatibility](#)

Related tasks

[Printing Your Document or Photo - Windows](#)

Paper Configuration Options - Windows

Select any of the available Paper Configuration options to fine-tune the quality of your print.

Paper Configuration

Color Density: -50 | 50 | + 0 (%)

Drying Time per Print Head Pass: 0 | 50 | 0 (0.1sec)

Paper Feed Adjustment: -70 | 70 | + 0 (0.01%)

Paper Suction: Standard | -1 | -2 | -3 | -4

Paper Thickness: 2 (0.1mm)

Platen Gap: Auto

Roll Paper Back Tension: Auto

Default OK Cancel Help

Color Density

Adjusts the ink saturation level.

Drying Time per Print Head Pass

Pauses print head movement for up to 5 seconds after each pass to allow ink to dry. This lets you print with non-Epson media and avoid smearing the ink.

Paper Feed Adjustment

Modifies the speed of the paper feeding to compensate for banding in the direction of the print head.

Paper Suction

Decreases the paper suction when printing on thin media, such as drafting paper or backlight film.

Paper Thickness

Adjusts the appearance of details in printouts based on paper thickness.

Note: If you have high speed (bi-directional) printing enabled and small type or fine details appear too thick, you may need to adjust the paper thickness setting.

Platen Gap

Adjusts the distance from the paper to the print head. (Use a wider setting if you are seeing edge marks or scuffs on your prints.)

Roll Paper Back Tension

Increases or automatically controls the tension for cloth or thin paper, or if the roll paper wrinkles during printing.

Parent topic: [Selecting Basic Print Settings - Windows](#)

Advanced B&W Photo Options - Windows

If you select **Advanced B&W Photo** as the Color option, you can easily produce neutral and toned black-and-white prints. Whether your photo is color or grayscale, you can use this screening and color management technology to create stunning black-and-white prints. Select **Custom** as the Mode setting, then click **Advanced** and select any of the available options.

Note: Advanced B&W Photo mode is not available for Commercial Edition printers (configured with the Violet ink).

Color Toning

Adds tone (hue) to your black-and-white output. The default is **Neutral**, which provides a neutral tonal scale print. You can also choose other popular presets such as **Cool**, **Warm**, and **Sepia**. Note that the presets affect the target in the tone color circle.

Tone

Changes the entire tonal scale of your black-and-white output. While **Darker** is the default setting, you may see better results if you choose **Dark**. The tone color circle adjusts the hue of your black-and-

white print. Click on any portion of the color wheel or enter corresponding values to customize the tone (hue) to add to your print. The closer you select to the edge of the wheel, the more color you add.

Brightness

Adjusts the overall lightness and darkness of your image.

Contrast

Adjusts the difference between the light and dark areas of your image.

Shadow Tonality

Controls tonality only in the shadow areas of your image.

Highlight Tonality

Controls tonality only in the highlight areas of your image.

Max Optical Density

Adjusts the overall density or focus of the print. Create a soft focus print by lowering the density setting.

Highlight Point Shift

Helps reduce gloss differential on glossy media by adding density to the highlights of your image.

Parent topic: [Selecting Basic Print Settings - Windows](#)

Print Quality Options - Windows

You can use the Speed/Quality slider to set the desired quality level and select any of the available Print Quality options to fine-tune the quality of your print. Some settings may be unavailable, depending on the paper type and border setting you have chosen.

High Speed

Speeds up printing but may reduce print quality.

Edge Smoothing

Smooths jagged edges in low-resolution images such as screen captures or images from the Web.

Finest Detail

Sharpens edges on vector-based data including text, graphics, and line art. (This setting does not affect photographs.)

Note: Enabling **Finest Detail** may decrease the print speed.

Parent topic: [Selecting Basic Print Settings - Windows](#)

Color Management Options - Windows

You can adjust the **Mode** setting to fine-tune the colors in your printout or turn off color management in your printer software.

If you select **Automatic** as the **Mode** setting, you can choose from these options:

Charts and Graphs

Intensifies colors and lightens the midtones and highlights of an image.

EPSON Standard (sRGB)

Increases the contrast in images.

Note: This is the standard mode for most photos and documents when not using an ICC profile.

Adobe RGB

Matches image colors to the Adobe RGB color standard. Use this setting if your source file was captured in Adobe RGB.

If you select **Custom** as the **Mode** setting, you can choose from these options:

Color Controls

Lets you select a **Color Mode** setting, individual settings for **Brightness**, **Contrast**, **Saturation**, and **Density**, and individual color tones. Depending on the selected color mode, you can also adjust the midtone density using the **Gamma** setting.

PhotoEnhance

Lets you choose from various Scene Correction settings to automatically analyze your photos.

Note: PhotoEnhance uses a sophisticated face recognition technology to optimize photos that include faces. For this to work, both eyes and the nose must be visible in the subject's face. If your photo includes a face with an intentional color cast, such as a statue, you may want to turn off **PhotoEnhance** to retain the special color effects.

ICM

Automatically adjusts colors based on the printer's ICC profile and the selected **Media Type** setting, using the Image Color Matching system. Click the **Advanced** button to choose the input profile and other settings.

Note: In most cases, you get better results by applying color management in your application, rather than in the printer driver.

Off (No Color Adjustment)

Turns off color management in your printer software so you can manage color using only your application software.

Note: An ICC profile is required if color management is turned off.

Parent topic: [Selecting Basic Print Settings - Windows](#)

Advanced Color Controls - Windows

If you selected **Custom** as the **Mode** setting and **Color Controls** from the dropdown menu, you can click the **Advanced** button to select detailed settings.

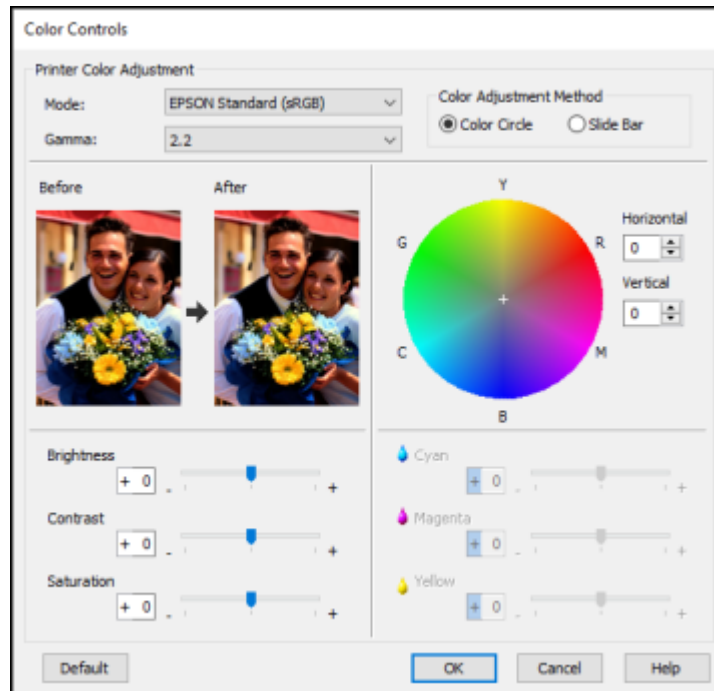

The Color Controls screen lets you specify values for adjusting brightness, contrast, saturation, and individual Cyan, Magenta, and Yellow color tones. You can choose from two Printer Color Adjustment modes and two Gamma settings, and use either a color circle or slide bar to adjust color.

Parent topic: [Selecting Basic Print Settings - Windows](#)

Paper Source Options - Windows

You can select any of the available options in the paper Source menu to print on the paper loaded in that source.

Roll Paper

Selects roll paper loaded in the roll paper holder.

Roll Paper (Banner)

Selects roll paper loaded in the roll paper holder for a series of continuous images without any margin space between them.

Paper Cassette

Selects the paper in the cassette.

Manual Feed

Selects the paper in the front or rear manual feeder.

Parent topic: [Selecting Basic Print Settings - Windows](#)

Roll Paper Options - Windows

Select any of the available roll paper options.

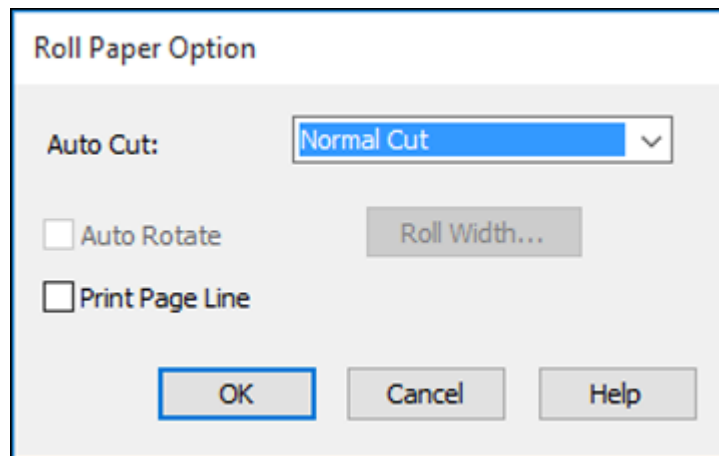

Note: Some settings may not be available, depending on the Roll Paper Option you selected for your paper size.

Auto Cut options:

- **Off:** Select this option to cut your prints manually.

- **Normal Cut:** Creates a margin at the top and bottom of your image. These margins vary by media type and may be changed from their defaults using custom media settings.

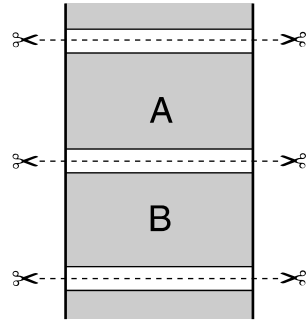

- **Single Cut:** Prints images within the same print job end-to-end with no gap between them. Borderless images may overlap slightly.

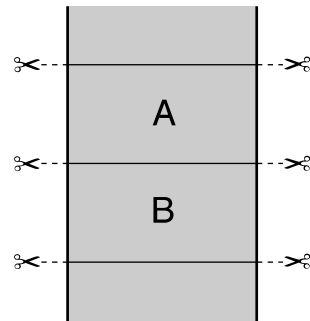

- **Double Cut:** Increases the space between each image and trims each print individually, providing the cleanest edge with no image overlap for borderless printing.

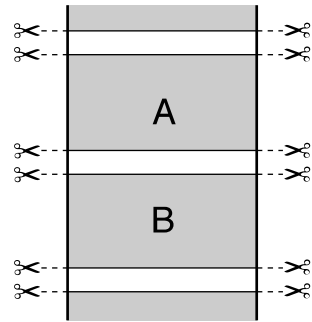

Auto Rotate

Automatically positions the image or file to fit the roll paper. When Auto Rotate is selected, select the width of the paper as the **Roll Width** setting.

Print Page Line

Prints lines between pages as a guide for manual cutting.

Parent topic: [Selecting Basic Print Settings - Windows](#)

Related references

[Borderless Paper Type Compatibility](#)

Using Layout Manager - Windows

Layout Manager lets you create a poster or display by dragging multiple pieces of print data created in different applications onto one sheet of paper for printing.

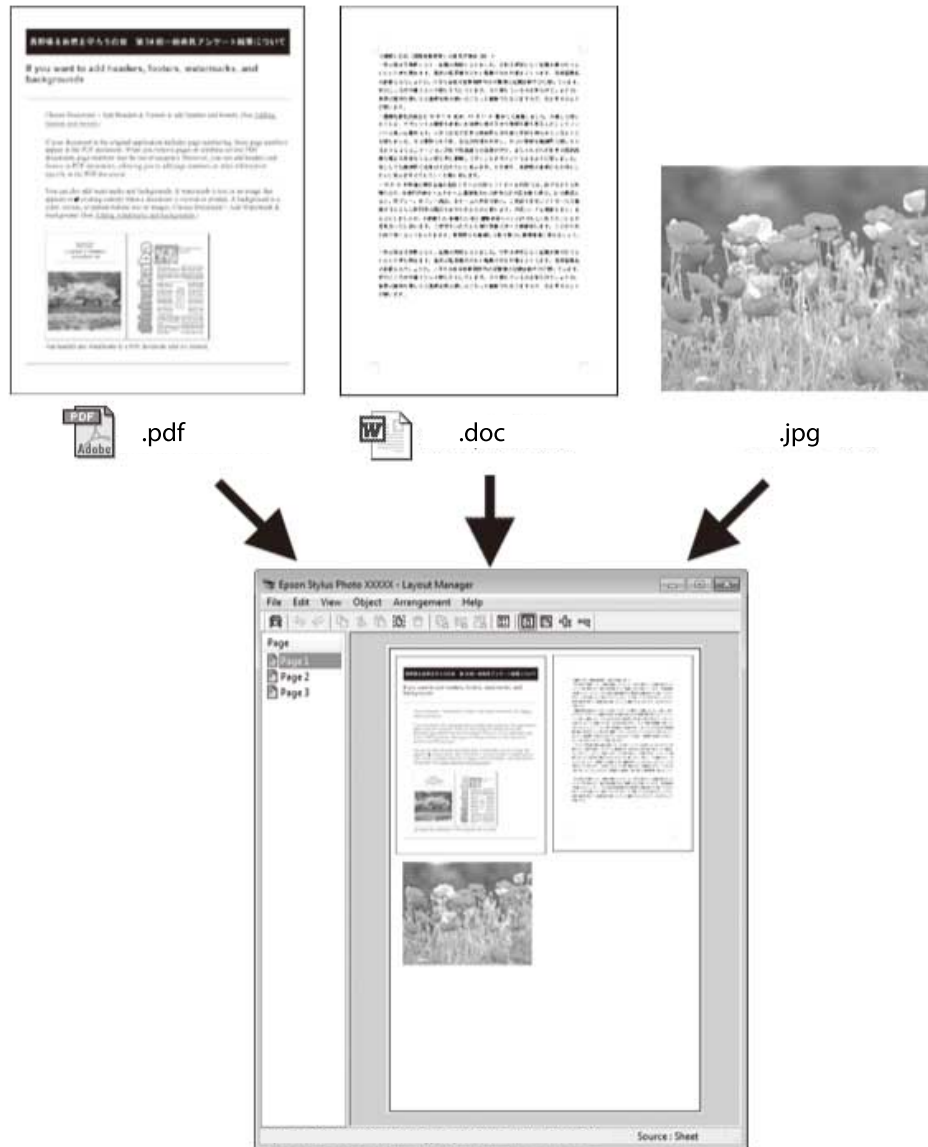

You can also place the same print data multiple times as shown here.



You can place print data in different sizes and orientations to maximize media usage, as shown here.

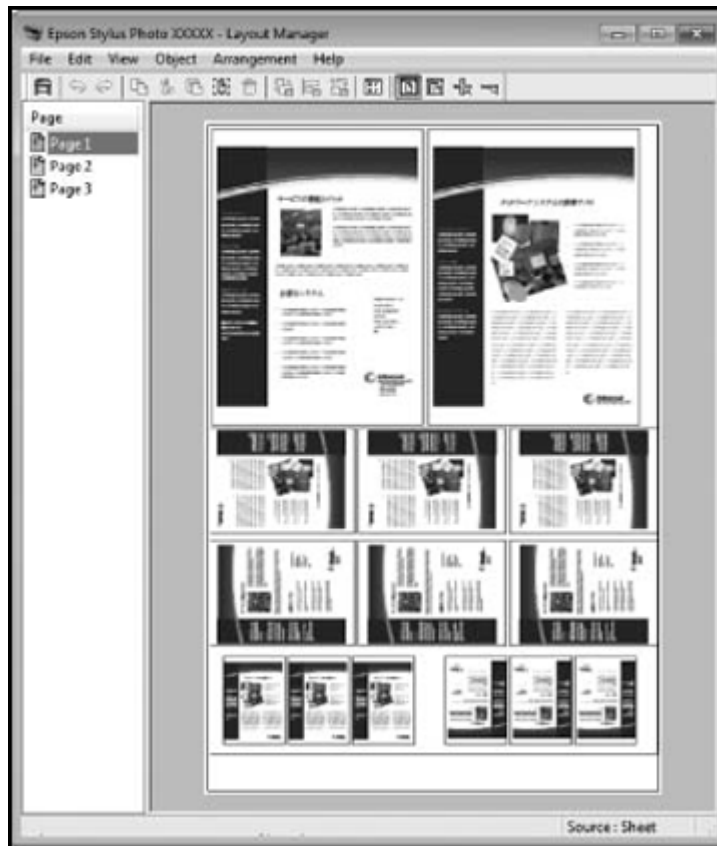

You can place print data on roll paper as shown here.

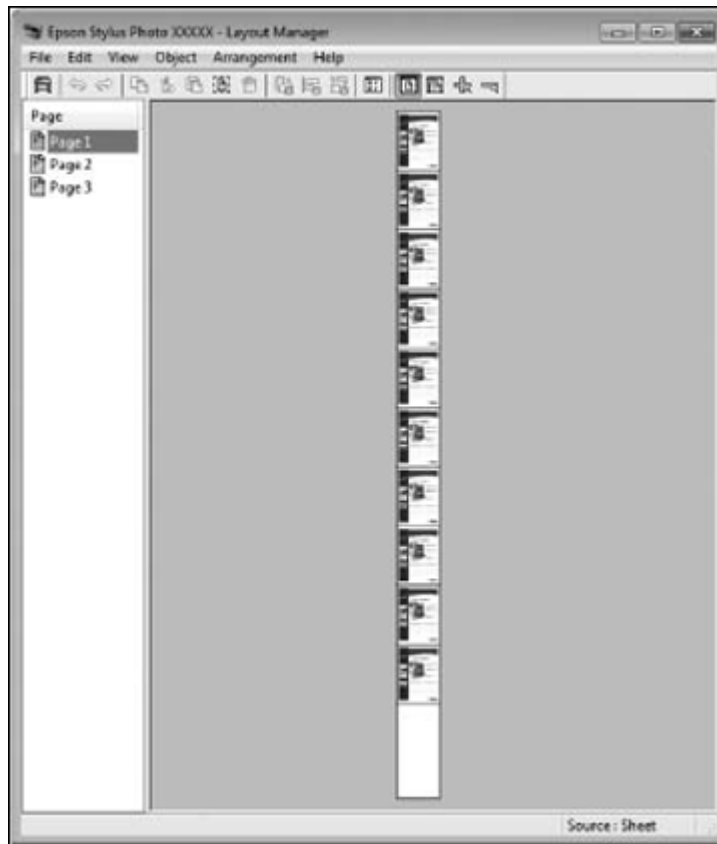

1. Open the file you want to print in your application.
2. Select the print command in your application.

3. Select **Layout Manager** on the Main tab and choose an option for the **Size** setting that matches the size of the document in your application.

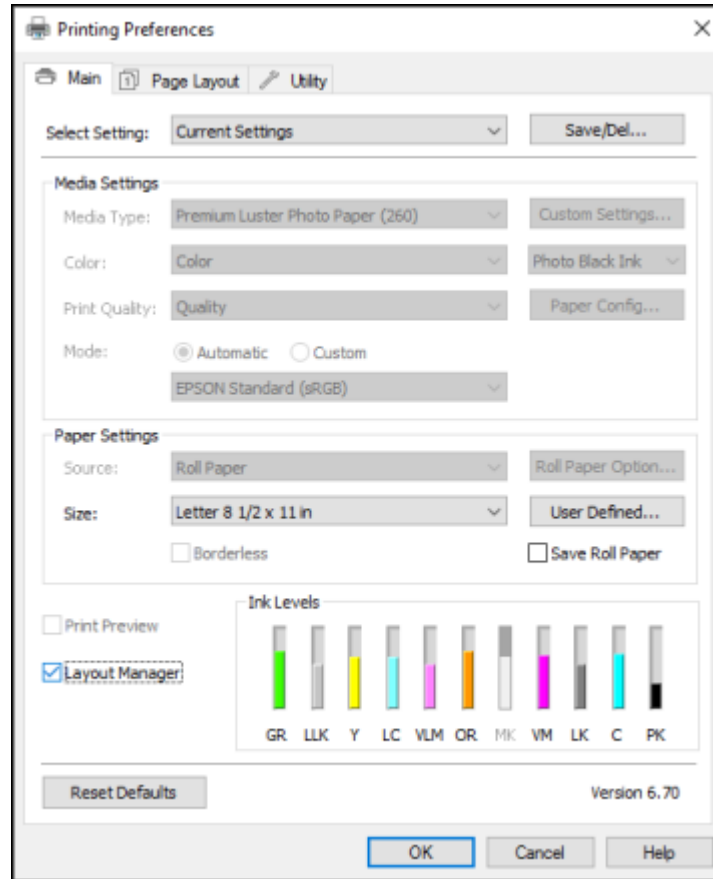

Note: You select the size of the paper you are printing on in a later step.

4. Click **OK** and then click **Print**, if necessary.
The Layout Manager screen opens and displays one page in the layout.
5. Leave the Layout Manager screen open and repeat steps 1 to 4 to arrange additional print data. The pages are added to the Layout Manager screen.

6. Do the following to arrange objects on the Layout Manager screen:
 - Drag pages to move and resize them.
 - Use the tool buttons and the Object menu to align and rotate pages.
 - Resize and replace whole pages in the Preference or Arrangement Settings screens.

Note: See the Layout Manager screen help for details.

7. Click **File > Properties**, then select your print settings, including the size of the paper you are printing on, on the Main tab.
8. Click the **File** menu on the Layout Manager screen and click **Print**.

Note: To save the current job to a file, click the **File** menu on the Layout Manager screen, save the file, and close the Layout Manager screen. To open the saved file later for editing or reprinting, right-click the printer icon in the Windows taskbar, click **Layout Manager**, and open the file.

Parent topic: [Selecting Basic Print Settings - Windows](#)

Selecting Print Layout Options - Windows

You can select a variety of sizing and layout options for your document or photo on the Page Layout tab.

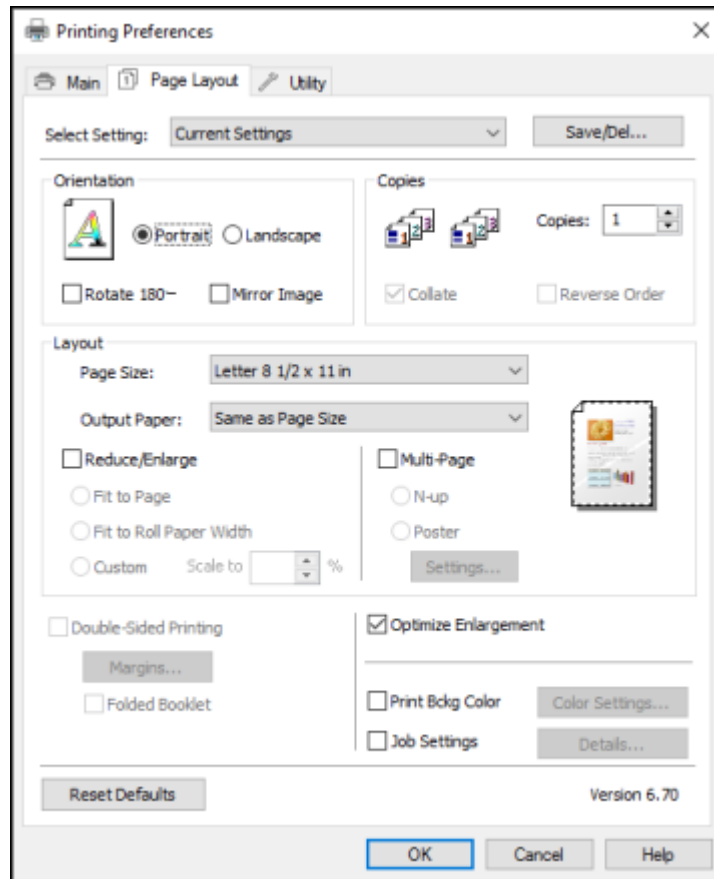

- To change the orientation of your printed document or photo, select the **Portrait** or **Landscape** checkbox.
- To rotate or flip the printed image, select the **Rotate 180°** or **Mirror Image** checkbox.
- To select multiple copies and their print order, select the **Copies**, **Collate**, and **Reverse Order** options.

- To change the size of your printed document or photo, select the **Reduce/Enlarge** checkbox and select sizing options.
- To print multiple pages on one sheet of paper, or print one image on multiple sheets of paper, select the **Multi-Page** checkbox and select the options you want.
- To enlarge your image beyond the limits of your application program, select the **Optimize Enlargement** checkbox.

Note: The driver can increase the image size up to 650% and decrease the output resolution to stay within the pixel limitations. Depending on the resolution of the original image and the print size, you may see reduced print quality.

- To print a color background on the page, select the **Print Bckg Color** checkbox and click **Color Settings** to select the color you want to use.
- To print the time, date, and other information about your print job at the top or bottom of the page, select the **Job Settings** checkbox and click **Details** to select the settings you want to use.
- To print on both sides of the paper, select the **Double-Sided Printing** checkbox and select the options you want.

[Reduce/Enlarge Options - Windows](#)

[Multi-Page Printing Options - Windows](#)

Parent topic: [Printing with Windows](#)

Reduce/Enlarge Options - Windows

You can select any of the Reduce/Enlarge options to size your printed image.

Fit to Page

Sizes your printed image to fit on the paper you loaded and selected as the Output Paper setting.

Fit to Roll Paper Width

Sizes your printed image to fit the width of the roll paper you loaded.

Custom

Sizes your printed image by the percentage you select as the **Scale to** setting.

Parent topic: [Selecting Print Layout Options - Windows](#)

Multi-Page Printing Options - Windows

You can select these Multi-Page options to set up your multi-page print job.

N-up

Prints 2 (**2-up**) or 4 (**4-up**) pages on one sheet of paper.

Poster

Prints one image on multiple sheets of paper to create a large poster with or without borders. Click the **Settings** button to select the layout and guideline options.

Parent topic: [Selecting Print Layout Options - Windows](#)

Selecting Additional Settings - Windows

You can run maintenance utilities and select additional settings that apply to all the print jobs you send to your product.

1. Access the Windows Desktop and right-click the product icon in the Windows taskbar.
2. Select **Printer Settings**.
3. Click the **Utility** tab.

You see a window like this:

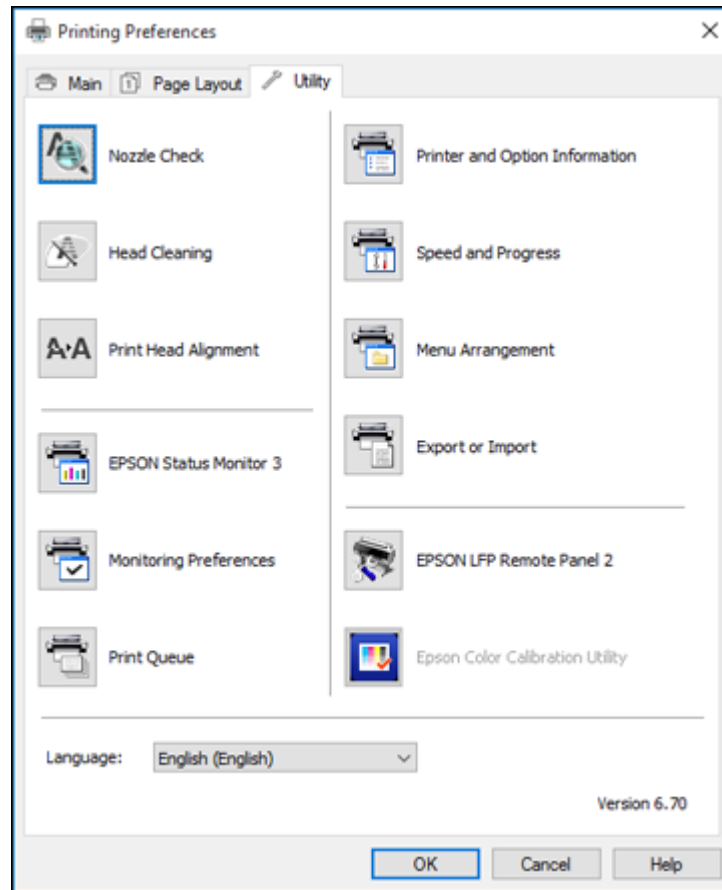

4. Select any of the following options, as necessary:
 - **Nozzle Check** to print a nozzle check pattern to check whether the print head nozzles are clogged.
 - **Head Cleaning** to clean the print head if you notice banding or gaps in your printouts.
 - **Print Head Alignment** to align the print head if printouts appear grainy or out of focus.
 - **Epson Status Monitor 3** to check the printer's status.

- **Monitoring Preferences** to select the error notifications displayed on the Epson Status Monitor 3 screen, or add a shortcut to the utility in the Windows taskbar.
- **Print Queue** to display a list of all waiting print jobs, view information on the data waiting to be printed, and delete or reprint the jobs.
- **Language** to select the language you want to use for the printer software screens.
- **Printer and Option Information** to set the time to turn off the printer automatically.
- **Speed and Progress** to select various printing options.
- **Menu Arrangement** to arrange the **Setting**, **Media Type**, and **Paper Size** options by frequency of use.
- **Export or Import** to save the print settings to a file or import them from a file. This is useful when you want to select the same print settings on multiple computers.
- **Epson LFP Remote Panel 2** to optimize printer settings and create and manage custom paper configurations. This option is available only if Epson LFP Remote Panel 2 is installed.
- **Epson Color Calibration Utility** to perform printer calibration. This option is available only if the Epson Color Calibration Utility is installed.

5. Click **OK** to close the printer software window.

Parent topic: [Printing with Windows](#)

Related tasks

[Checking the Nozzles Using a Computer Utility](#)

[Cleaning the Print Head Using a Computer Utility](#)

[Aligning the Print Head Automatically Using a Computer Utility](#)

Printing Your Document or Photo - Windows

Once you have selected your print settings, you are ready to save your settings and print.

1. Click **OK** to save your settings.

You see your application's Print window, such as this one:

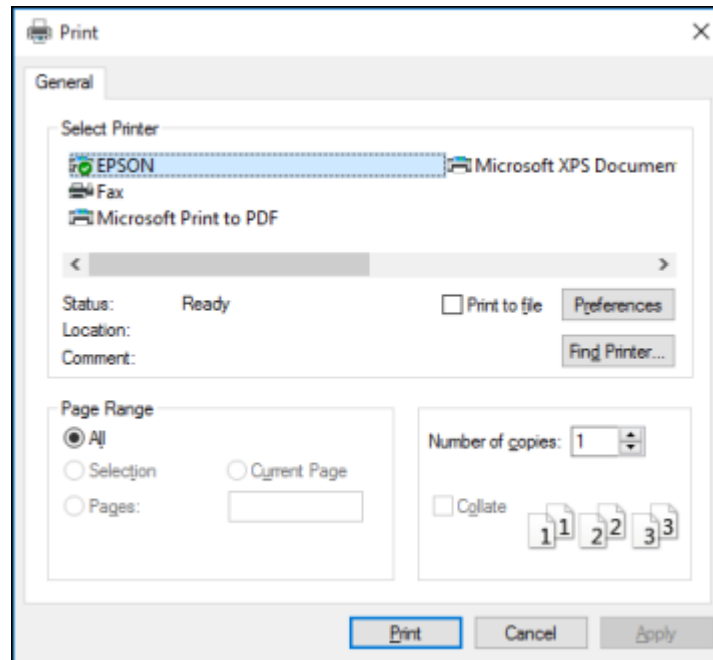

2. Click **OK** or **Print** to start printing.

[Checking Print Status - Windows](#)

Parent topic: [Printing with Windows](#)

Checking Print Status - Windows

During printing, you see this window showing the progress of your print job. It allows you to control printing and check ink cartridge status.

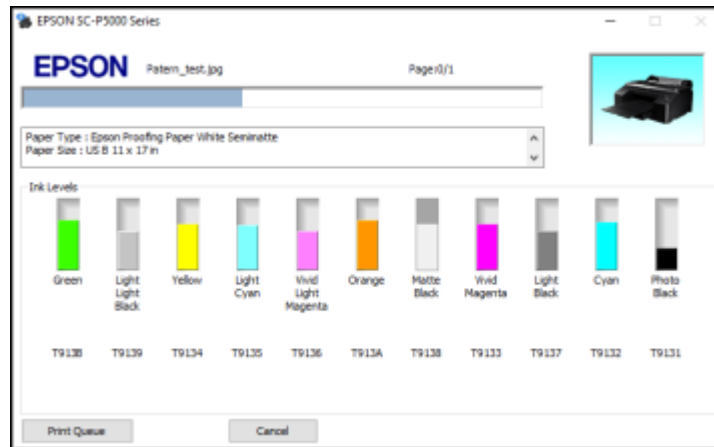

- To cancel printing, click **Cancel**.
- To see print jobs waiting to print or to cancel printing, click **Print Queue**.

Parent topic: [Printing Your Document or Photo - Windows](#)

Saving, Sharing, and Customizing the Printer Settings

You can save groups of print settings or media settings so you can reuse them for future print jobs. You can export these settings as a file so you can share them with other users. You can also edit the settings displayed in the printer software screens.

[Saving and Sharing Print Settings - Windows](#)

[Saving and Sharing Media Settings - Windows](#)

[Editing Print Setting Displays - Windows](#)

Parent topic: [Printing with Windows](#)

Saving and Sharing Print Settings - Windows

You can save your print settings so you can use them for future print jobs.

1. Select the print settings you want to save.

2. Click **Save/Del** at the top of the Main or Page Layout tab in your printer software.
You see a window like this:

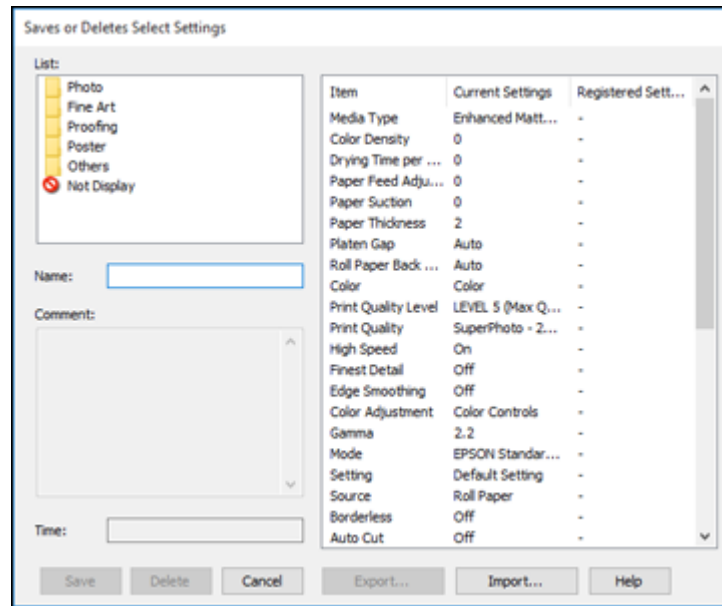

3. Verify that your settings are correct, enter a name for the group of settings in the **Name** field, and click **Save**.

Note: If you need to delete a group of settings you have created, select the name of the group of settings from the list and click **Delete**.

4. Do the following as necessary:
 - Select the name of the group of settings from the Select Setting list and use them to print.
 - To export the settings, click **Save/Del**, select the name of the group of settings, click **Export**, select a location, and enter a file name.
 - To import a group of settings, click **Save/Del**, click **Import**, select the file you want to use, and click **Open**. Then use the settings to print.

Parent topic: [Saving, Sharing, and Customizing the Printer Settings](#)

Related tasks

[Selecting Basic Print Settings - Windows](#)

[Printing Your Document or Photo - Windows](#)

Saving and Sharing Media Settings - Windows

You can save and share settings you have selected for a particular media type so you can use them for future print jobs.

1. Select the Media Settings you want to save on the Main tab, as necessary.
2. Click **Custom Settings**.

You see a window like this:

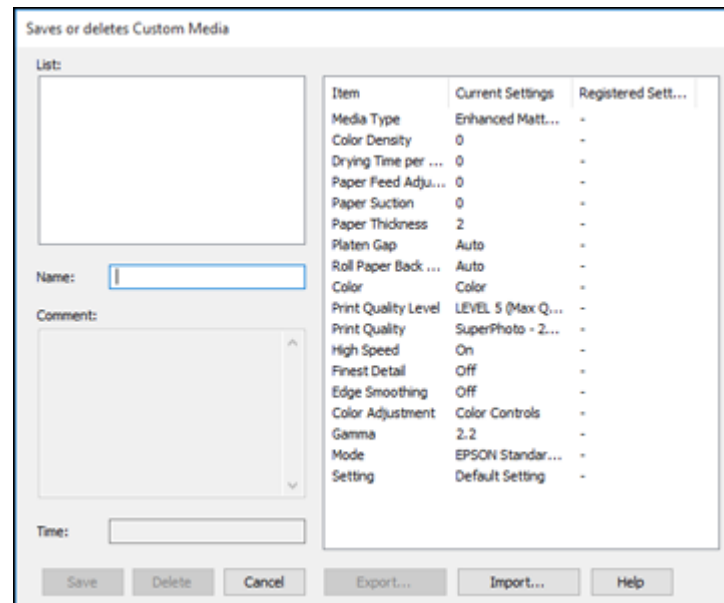

3. Verify that your settings are correct, enter a name for the media settings in the **Name** field, and click **Save**.

Note: If you need to delete a group of settings you have created, select the name of the settings from the list and click **Delete**.

4. Do the following as necessary:
 - Select the name of a media setting as the **Media Type** setting and use it to print.
 - To export the settings, click **Custom Settings**, select the name of the media settings, click **Export**, select a location, and enter a file name.
 - To import settings, click **Custom Settings**, select the name of the media settings, click **Import**, select the file you want to use, and click **Open**. Then use these settings to print.

Parent topic: [Saving, Sharing, and Customizing the Printer Settings](#)

Related tasks

[Selecting Basic Print Settings - Windows](#)

[Printing Your Document or Photo - Windows](#)

Editing Print Setting Displays - Windows

You can arrange the displayed print settings so you can easily select the settings you use most often.

1. Click the **Utility** tab in the printer software.
2. Select **Menu Arrangement**.

You see this window:

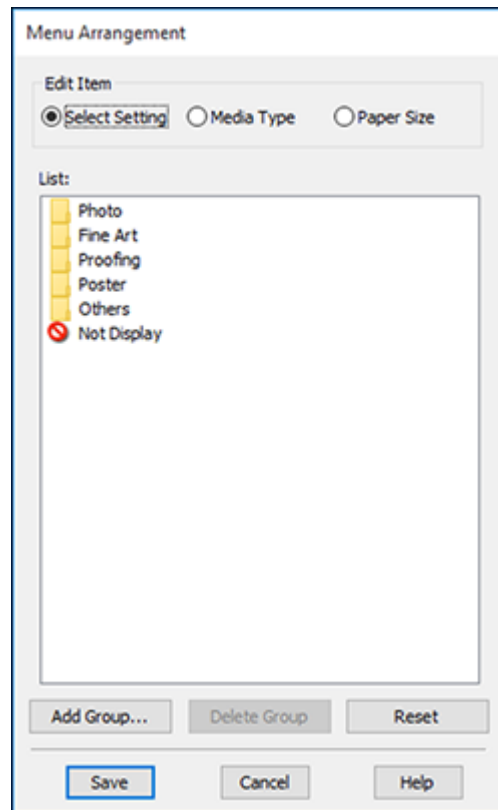

3. Select the item you want to edit.
4. Order or group items in the **List** box as follows:
 - To move and reorder items, drag and drop them in the list.
 - To add a new group (folder), click **Add Group**.
 - To delete a group (folder), select the group and click **Delete Group**.
 - To hide a group, drag and drop it to **Not Display**.

Note: If you delete a group, the group folder is deleted but the items within the folder remain.

5. Click **Save**.

Parent topic: [Saving, Sharing, and Customizing the Printer Settings](#)

Selecting Default Print Settings - Windows

When you change your print settings in a program, the changes apply only while you are printing in that program session. If you want to change the print settings you use in all your Windows programs, you can select new default print settings.

1. Access the Windows Desktop and right-click the product icon in the Windows taskbar.
2. Select **Printer Settings**.

You see the printer settings window:

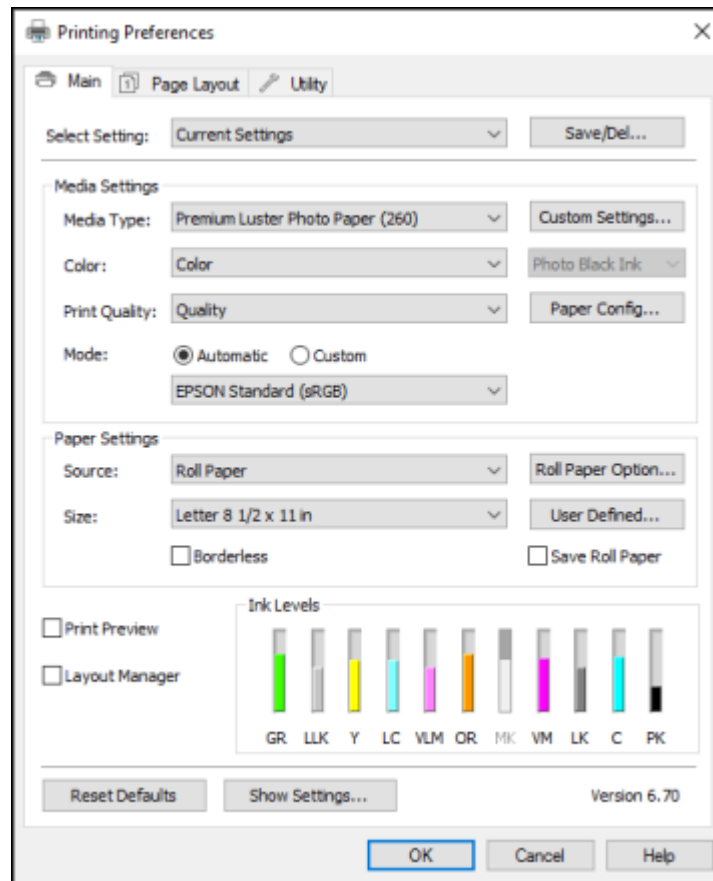

3. Select the print settings you want to use as defaults in all your Windows programs.
4. Click **OK**.

These settings are now the defaults selected for printing. You can still change them as needed for printing in any program session.

Parent topic: [Printing with Windows](#)

Related tasks

[Selecting Basic Print Settings - Windows](#)

Changing the Language of the Printer Software Screens

You can change the language used on the Windows printer software screens.

1. Access the Windows Desktop and right-click the product icon in the Windows taskbar.
2. Select **Printer Settings**.
You see the printer settings window.
3. Click the **Utility** tab.

You see these options:

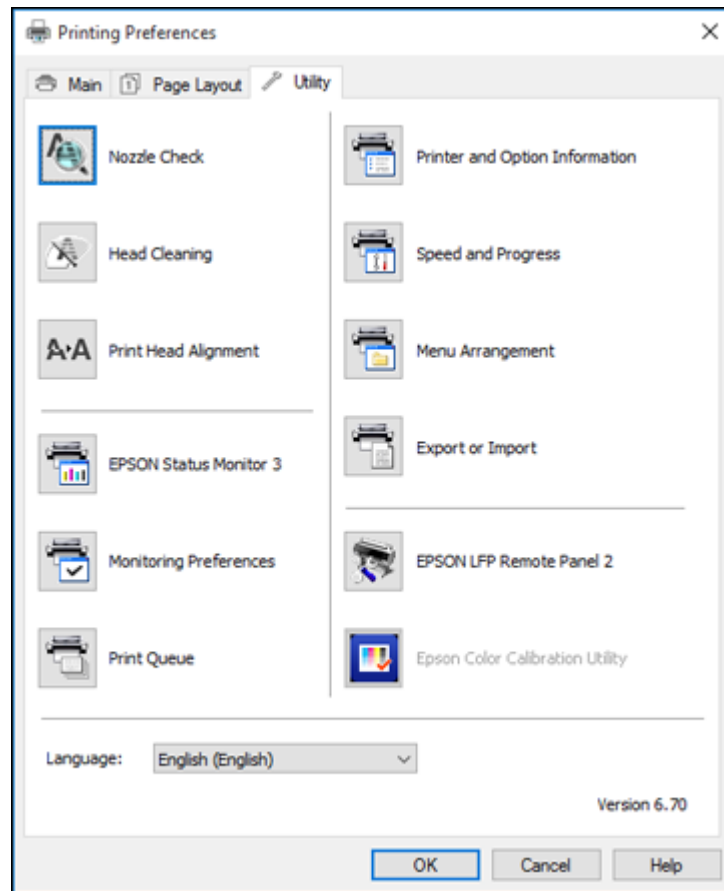

4. Select the language you want to use as the **Language** setting.
5. Click **OK** to close the printer software window.

The printer software screens appear in the language you selected the next time you access them.

Parent topic: [Printing with Windows](#)

Changing Automatic Update Options

Your printer software for Windows automatically checks for updates to the product software. You can change how often the software checks for updates or disable this feature.

1. Access the Windows Desktop and right-click the product icon in the Windows taskbar.
2. Select **Software Update Settings**.

You see this window:

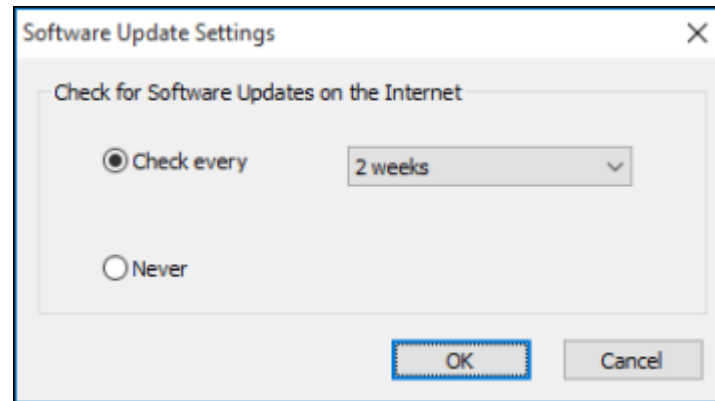

3. Do one of the following:
 - To change how often the software checks for updates, select a setting in the **Check every** menu.
 - To disable the automatic update feature, select the **Never** option.
4. Click **OK** to exit.

Note: If you choose to disable the automatic update feature, you can check for updates manually.

Parent topic: [Printing with Windows](#)

Printing on a Mac

You can print with your product using any Mac printing program, as described in these sections.

Note: If you have an Internet connection, it is a good idea to check for updates to your product software on Epson's support website.

- [Selecting Basic Print Settings - Mac](#)
- [Selecting Print Layout Options - Mac](#)
- [Selecting Roll Paper Settings - Mac](#)
- [Selecting Advanced Media Control Settings - Mac](#)
- [Managing Color - Mac](#)
- [Sizing Printed Images - Mac](#)
- [Selecting Printing Preferences - Mac](#)
- [Printing Your Document or Photo - Mac](#)

Parent topic: [Printing from a Computer](#)

Selecting Basic Print Settings - Mac

Select the basic settings for the photo or document you want to print.

1. Open a photo or document for printing.
2. Select the print command in your application.

Note: You may need to select a print icon on your screen, the **Print** option in the File menu, or another command. See your application's help utility for details.

3. Select your product as the **Printer** setting.

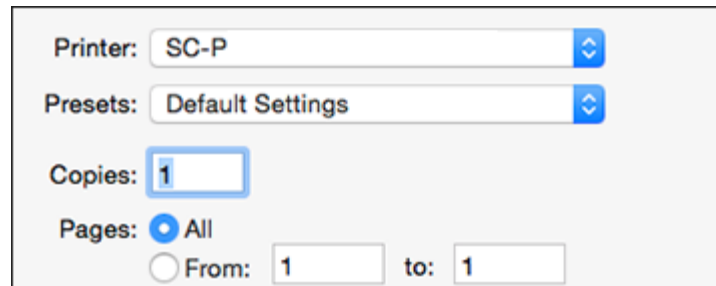

Printer: SC-P

Presets: Default Settings

Copies: 1

Pages: All

From: 1 to: 1

4. If necessary, click the arrow next to the Printer setting or the **Show Details** button to expand the print window.

You see the expanded printer settings window for your product:

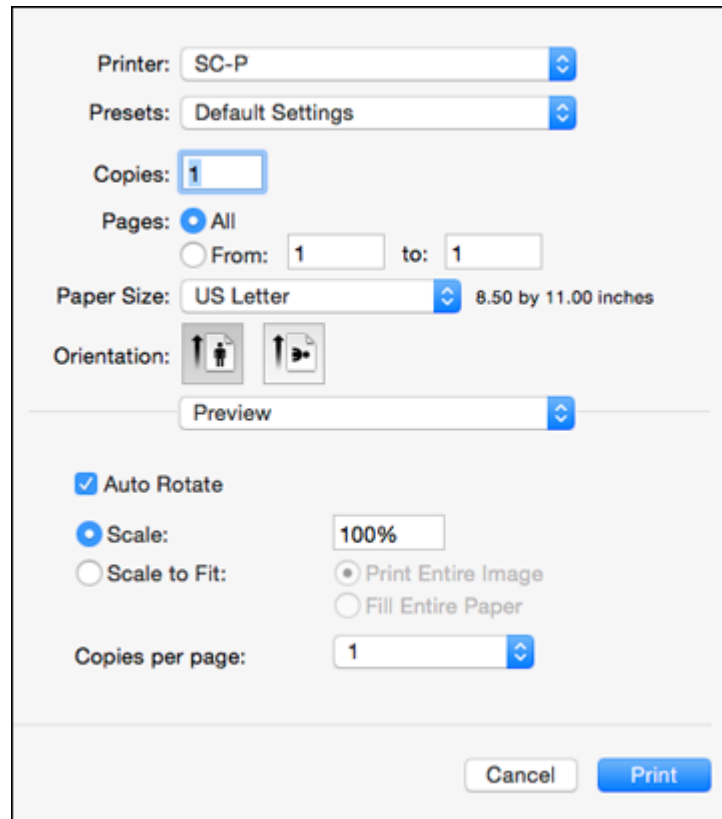

Note: The print window may look different, depending on the Mac OS version and the application you are using.

5. Select the **Copies** and **Pages** settings as necessary.

Note: If you do not see these settings in the print window, check for them in your application before printing. They may be accessible by selecting **Page Setup** from the File menu.

6. Select the size of the paper you loaded as the **Paper Size** setting.
 - To print a borderless photo, select the **Borderless** checkbox or a paper size with a **Borderless** option. You can also create a custom paper size, but the highest available **Output Resolution** setting is limited to **Fine - 360 dpi**.
 - To print on roll paper, select a roll paper size or one with a **Borderless** option.

Note: For roll paper, make sure the maximum width of your photo is set to 17 inches to fit in the width of your roll paper (set the margins to 0 in your application software).

Note: You can reduce or enlarge the size of the printed image by selecting **Paper Handling** from the pop-up menu and selecting a scaling option.

7. Choose portrait or landscape as the **Orientation** setting.
8. Select any application-specific settings that appear on the screen, such as those shown in the image above for the Preview application.
9. Select **Printer Settings** from the pop-up menu.

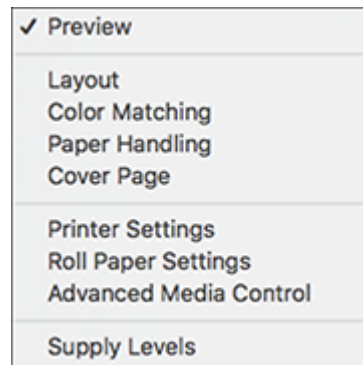

Note: In certain programs, you may need to select **Advanced** before you can select **Printer Settings**. For more information about printer settings, click the ? button.

You see these settings:

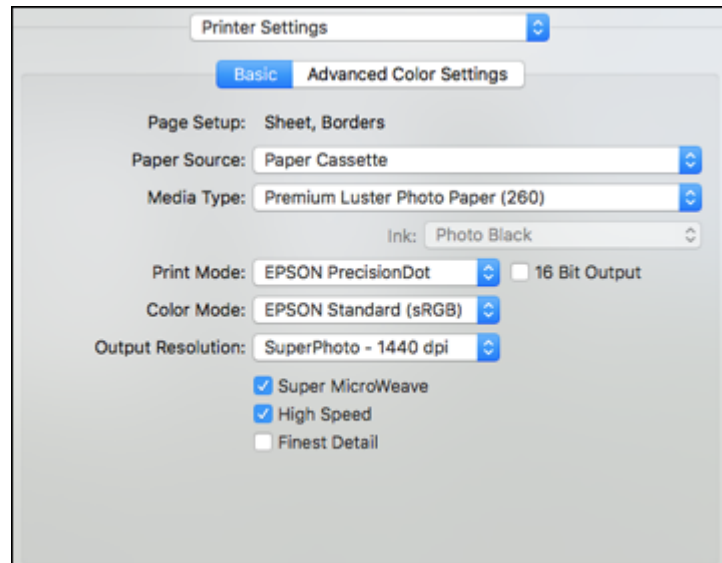

10. Select the **Paper Source** setting.
11. Select the type of paper you loaded as the **Media Type** setting.

Note: The setting may not exactly match the name of your paper. Check the media type settings list for details.

Note: The **Ink** setting may change depending on the size and type of paper you select. To avoid changing black ink more often than necessary, set the printer to the type of black ink you usually use on the control panel.

12. Select one of the following as the **Print Mode** setting:
 - Select **EPSON PrecisionDot** for any type of photographic printing.
 - Select **Advanced B&W Photo** to print black-and-white photos on certain types of photo paper. See the list of Advanced B&W Photo options for details.
 - Select **Black/Grayscale** when using plain paper.

13. Select one of the following as the **Color Mode** setting:

- **Charts and Graphs**: Performs color correction based on the sRGB space. Click the **Advanced Color Settings** tab to use advanced color controls.
- **EPSON Standard (sRGB)**: Increases the contrast in images. Click the **Advanced Color Settings** tab to use advanced color controls.
- **Adobe RGB**: Matches image colors to the Adobe RGB color standard. Use this setting if your source file was captured in Adobe RGB. Click the **Advanced Color Settings** tab to use advanced color controls.
- **Off (No Color Adjustment)**: Turns off color management in your printer software so you can manage color using only your application software.

Note: If desired, you can instead use ColorSync to manage colors. In most cases, you get better results by applying color management in your application, rather than in the printer driver.

14. Select the **Output Resolution** setting you want to use.

15. Select any of the available print options.

[Advanced Color Settings - Mac](#)

[Output Resolution Settings - Mac](#)

[Print Options - Mac](#)

Parent topic: [Printing on a Mac](#)

Related tasks

[Selecting Roll Paper Settings - Mac](#)

[Printing Your Document or Photo - Mac](#)

Advanced Color Settings - Mac

When you click the **Advanced Color Settings** tab, you see one of the screens below depending on the **Print Mode** setting you selected.

- **EPSON PrecisionDot**

You can specify values for adjusting gamma, brightness, contrast, saturation, and individual Cyan, Magenta, and Yellow color tones.

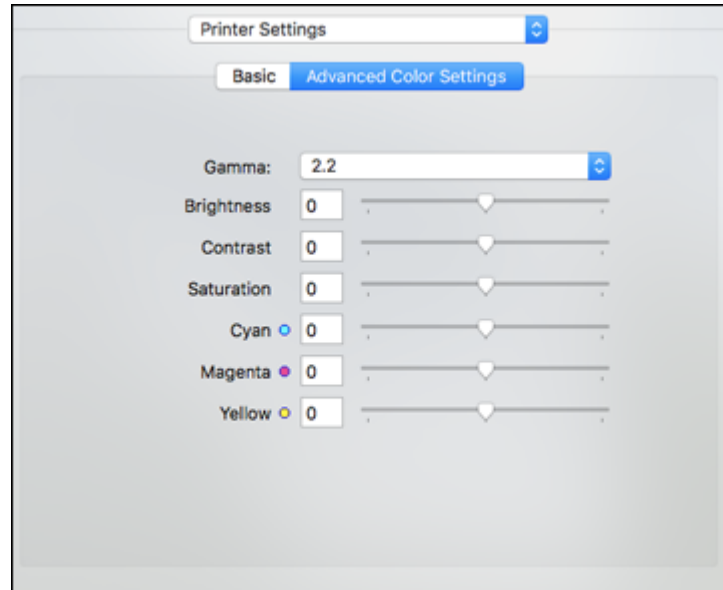

- **Advanced B&W Photo**

You can select any of the available options.

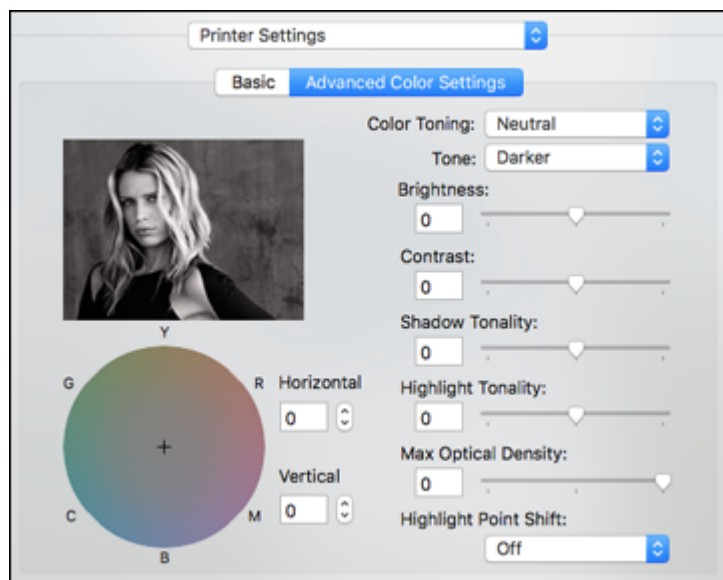

Color Toning

Adds tone (hue) to your black-and-white output. The default is **Neutral**, which provides a neutral tonal scale print. You can also choose other popular presets such as **Cool**, **Warm**, and **Sepia**. Note that the presets affect the target in the tone color circle.

Tone

Changes the entire tonal scale of your black-and-white output. While **Darker** is the default setting, you may see better results if you choose **Dark**. The tone color circle adjusts the hue of your black-and-white print. Click on any portion of the color wheel or enter corresponding values to customize the tone (hue) to add to your print. The closer you select to the edge of the wheel, the more color you add.

Brightness

Adjusts the overall lightness and darkness of your image.

Contrast

Adjusts the difference between the light and dark areas of the overall image.

Shadow Tonality

Controls tonality only in the shadow areas of your image.

Highlight Tonality

Controls tonality only in the highlight areas of your image.

Max Optical Density

Adjusts the overall density or focus of the print. Create a soft focus print by lowering the density setting.

Highlight Point Shift

Helps reduce gloss differential on glossy media by adding density to the highlights of your image.

Parent topic: [Selecting Basic Print Settings - Mac](#)

Output Resolution Settings - Mac

You can select any of the **Output Resolution** settings to fine-tune the quality of your print. Some settings may be unavailable, depending on the paper type and border setting you have chosen.

Draft - 180 dpi

For draft printing on plain paper at low resolution

Draft - 360 dpi

For draft printing on plain paper.

Fine - 720 dpi

For everyday text and image printing.

Fine - 1440 dpi

For everyday text and image printing with higher print quality.

SuperPhoto - 1440 dpi

For photos and graphics with good print quality and speed.

SuperPhoto - 2880 dpi

For the best print quality but the slowest print speed.

Parent topic: [Selecting Basic Print Settings - Mac](#)

Print Options - Mac

You can select any of the print options to customize your print. Some options may be unavailable, depending on other settings you have chosen.

Super Microweave

Increases detail but may reduce print speed.

High Speed

Speeds up printing but may reduce print quality.

Finest Detail

Sharpens edges on vector-based data including text, graphics, and line art. (This setting does not affect photographs.)

Note: Enabling **Finest Detail** may decrease the print speed.

Parent topic: [Selecting Basic Print Settings - Mac](#)

Selecting Print Layout Options - Mac

You can select a variety of layout options by selecting **Layout** from the pop-up menu on the print window.

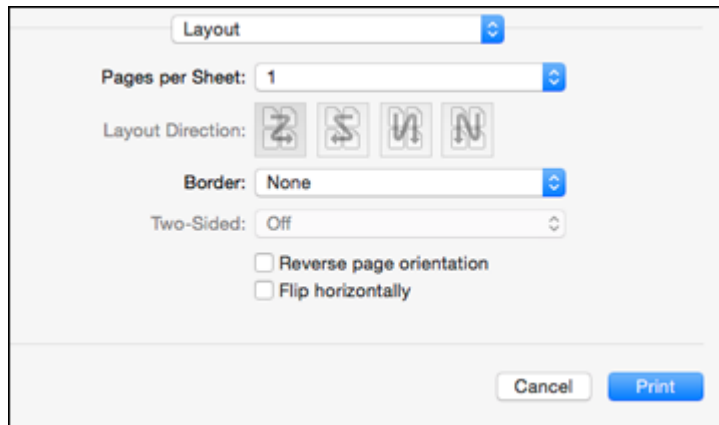

- To print multiple pages on one sheet of paper, select the number of pages in the **Pages per Sheet** pop-up menu. To arrange the print order of the pages, select a **Layout Direction** setting.
- To print borders around each page on the sheet, select a line setting from the **Border** pop-up menu.
- To invert or flip the printed image, select the **Reverse page orientation** or **Flip horizontally** settings.

Parent topic: [Printing on a Mac](#)

Selecting Roll Paper Settings - Mac

To print on roll paper, you select the roll paper size and roll paper options from the Printer Settings menu.

1. Select **Roll Paper Settings**.

You see this window:

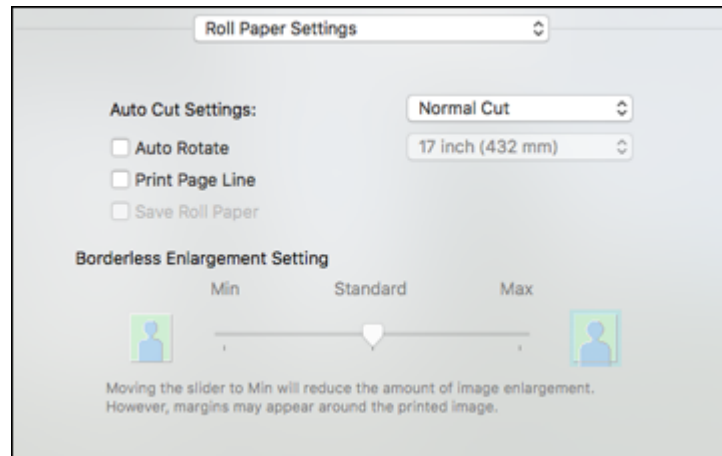

Note: Some settings may not be available, depending on the Roll Paper option you selected for your Paper Size.

2. Select one of the following **Auto Cut Settings**:
 - **Off:** Select this option to cut your prints manually.
 - **Normal Cut:** Creates a margin and the top and bottom of your image. These margins vary by media type and may be changed from their defaults using custom media settings.

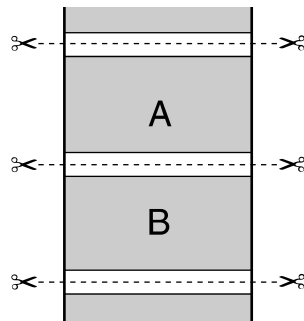

- **Single Cut:** Prints images within the same print job end-to-end with no gap between them. Borderless images may overlap slightly.

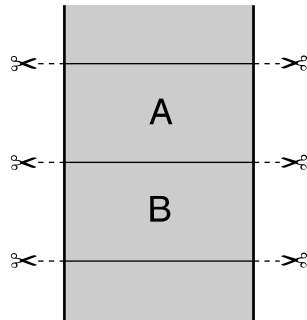

- **Double Cut:** Increases the space between each image and trims each print individually, providing the cleanest edge with no image overlap for borderless printing.

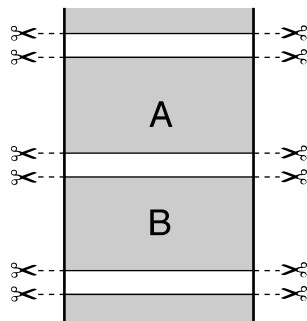

3. Select the following settings as necessary:
 - Select the **Auto Rotate** checkbox and select the roll paper width to fit the images to the paper size.
 - Select the **Print Page Line** checkbox to print trim lines around images when you select a banner paper size.
 - Click **Save Roll Paper** to minimize the amount of blank paper wasted when you print on banner paper.

- Use the **Expansion** slider to adjust the amount of image expansion when printing borderless images.

Note: This option is available only when you choose a Paper Size setting with a **Borderless** option.

4. Click **Print**.

Parent topic: [Printing on a Mac](#)

Related references

[Borderless Paper Type Compatibility](#)

Selecting Advanced Media Control Settings - Mac

If you are using non-Epson media and need to fine-tune its print quality, select **Advanced Media Control** from the pop-up menu. Select the available options as necessary.

Note: Before adjusting the Advanced Media Control settings, select the **Media Type** setting that is closest to the paper you are using.

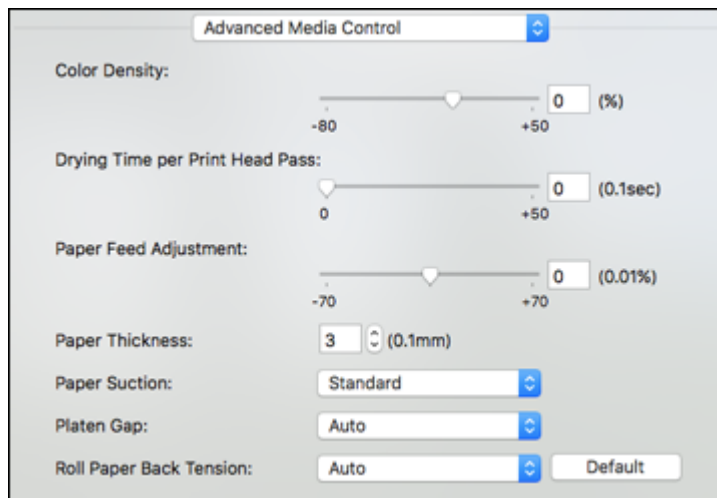

[Advanced Media Control Options - Mac](#)

Parent topic: [Printing on a Mac](#)

Advanced Media Control Options - Mac

Select any of the available Advanced Media Control options to fine-tune the quality of your printouts.

Color Density

Adjusts the ink saturation level.

Drying Time per Print Head Pass

Pauses print head movement for up to 5 seconds after each pass to allow ink to dry. This lets you print with non-Epson media and avoid smearing the ink.

Paper Feed Adjustment

Modifies the speed of the paper feeding to compensate for banding in the direction of the print head.

Paper Thickness

Adjusts the appearance of details in printouts based on paper thickness.

Note: If you have high speed (bi-directional) printing enabled and small type or fine details appear too thick, you may need to adjust the paper thickness setting.

Paper Suction

Decreases the paper suction when printing on thin media, such as drafting paper or backlight film.

Platen Gap

Adjusts the distance from the paper to the print head. (Use a wider setting if you are seeing edge marks or scuffs on your prints.)

Roll Paper Back Tension

Increases or automatically controls the tension for cloth or thin paper, or if the roll paper wrinkles during printing.

Parent topic: [Selecting Advanced Media Control Settings - Mac](#)

Managing Color - Mac

You can adjust the Color Matching settings to fine-tune the colors in your printout, or turn off color management in your printer software.

1. Select **Color Matching** from the pop-up menu in the print window.

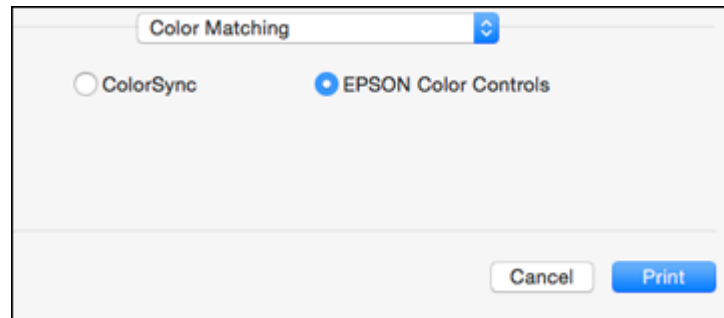

2. Select one of the available options.

[Color Matching Options - Mac](#)

Parent topic: [Printing on a Mac](#)

Color Matching Options - Mac

You can select from these settings on the **Color Matching** menu.

ColorSync

Prints using standard color profiles for your product and paper to help match image colors. You can customize the conversion method and filter settings on the ColorSync pop-up menu in the print window.

EPSON Color Controls

Lets you manage color using controls in your printer software or turn off color management.

Parent topic: [Managing Color - Mac](#)

Sizing Printed Images - Mac

You can adjust the size of the image as you print it by selecting **Paper Handling** from the pop-up menu on the Print window.

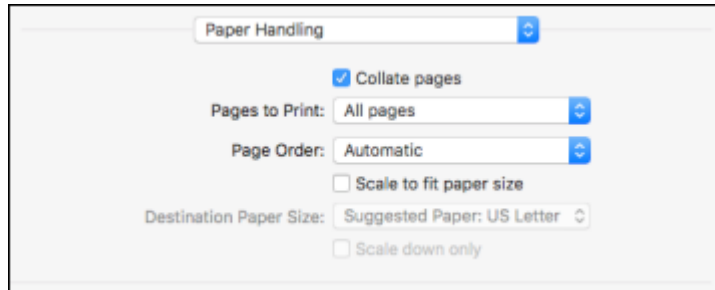

- To collate multiple copies into sets of documents, select the **Collate pages** checkbox.
- To print only selected pages in a multi-page document, select an option from the **Pages to Print** pop-up menu.
- To adjust the order in which pages are printed, select an option from the **Page Order** pop-up menu.
- To scale the image to fit on a specific paper size, select the **Scale to fit paper size** checkbox and select a paper size from the **Destination Paper Size** pop-up menu.
- To restrict scaling of the image to reduced sizing, select the **Scale down only** checkbox. (Deselect this checkbox when enlarging the image.)

Parent topic: [Printing on a Mac](#)

Selecting Printing Preferences - Mac

You can select printing preferences that apply to all the print jobs you send to your product.

1. In the Apple menu or the Dock, select **System Preferences**.
2. Select **Print & Fax**, **Print & Scan**, or **Printers & Scanners**, select your product, and select **Options & Supplies**.
3. Select **Options**.

You see a screen like this:

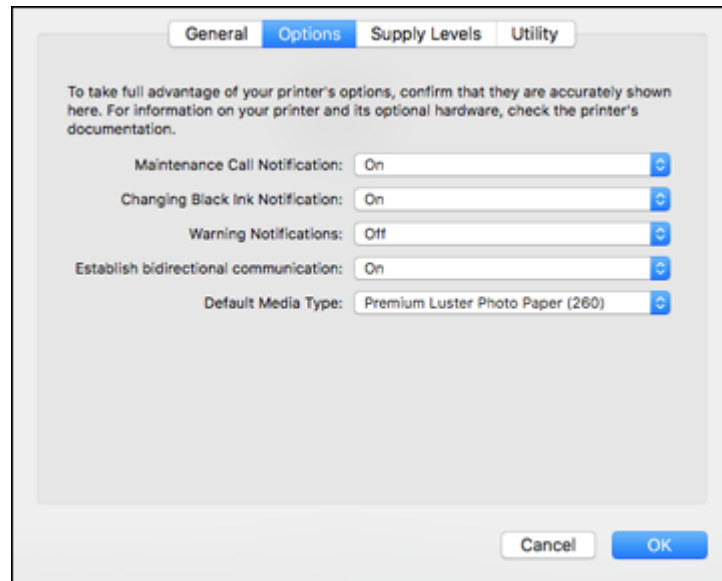

4. Select any of the available printing options.
5. Click **OK**.

[Printing Preferences - Mac](#)

Parent topic: [Printing on a Mac](#)

Printing Preferences - Mac

You can select from these settings on the **Options** tab.

Maintenance Call Notification

Alerts you if the maintenance tanks are nearing capacity or need to be replaced.

Changing Black Ink Notification

Alerts you if the selected black ink type does not match what is selected in the printer software.

Warning Notifications

Lets you choose whether or not to receive warning notifications from the printer software for various operating conditions.

Establish bidirectional communication

Allows the product to communicate with the computer. Do not change the default setting unless you experience issues when using a shared printing pool.

Default media type

Select the Media Type that you want to use as the default in the printer driver.

Parent topic: [Selecting Printing Preferences - Mac](#)

Printing Your Document or Photo - Mac

Once you have selected your print settings, you are ready to print.

Click **Print** at the bottom of the print window.

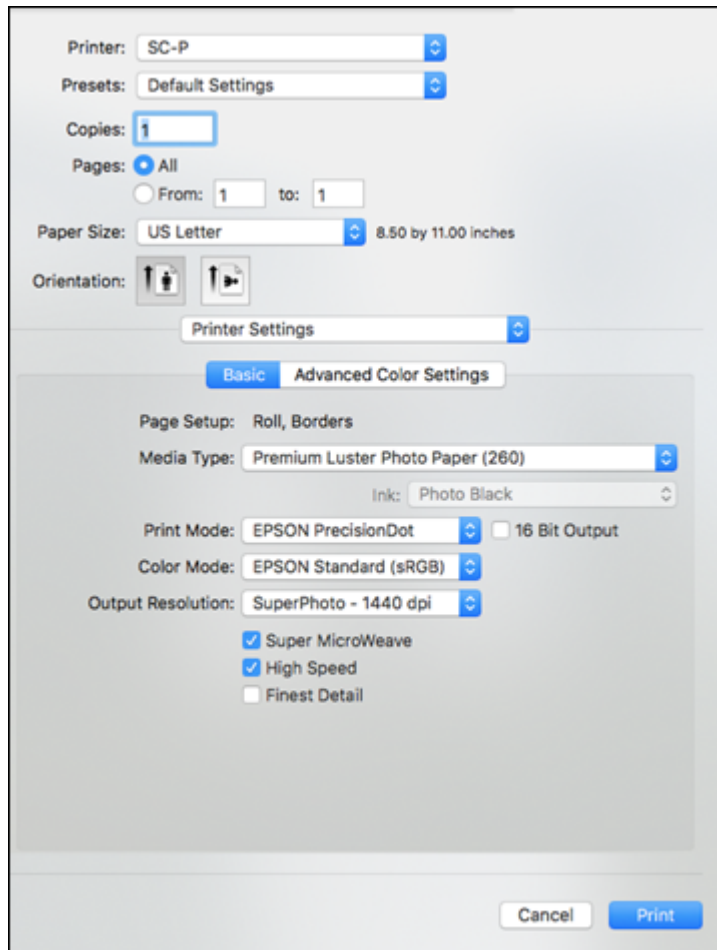

[Checking Print Status - Mac](#)

Parent topic: [Printing on a Mac](#)

Related tasks

[Selecting Basic Print Settings - Mac](#)



Checking Print Status - Mac

During printing, you can view the progress of your print job, control printing, and check ink status.

1. Click the printer icon when it appears in the Dock.

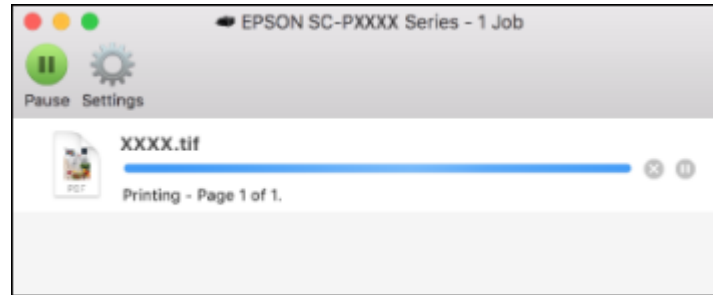
You see the print status window:



2. Select the following options as necessary for your Mac OS version:
 - To cancel printing, click the print job and click  or **Delete**.
 - To pause a print job, click the print job and click  or **Hold**. To resume a print job, click the paused print job and click  or **Resume**.
 - To pause printing for all queued print jobs, click **Pause** or **Pause Printer**.
 - To display other printer information, click **Settings** or **Supply Levels**.

Parent topic: [Printing Your Document or Photo - Mac](#)

Using the Control Panel Menus

Follow the instructions in these sections to access the printer menu system and select settings.

[Accessing the Printer's Menus](#)

[Maintenance Menu Settings](#)

[Paper Menu Settings](#)

[Printer Setup Menu Settings](#)

[Printer Status Menu Settings](#)

[Network Setup Menu Settings](#)

[Preferences Menu Settings](#)

[Administrator Menu Settings](#)

Accessing the Printer's Menus

You can use the printer menus to adjust the settings that control how your printer works.

1. Press the **Menu** button on the control panel.
You see the menu on the LCD screen.
2. Press the up or down arrow button to scroll through the menus.

Note: To return to the previous menu, press the left arrow button.

3. To change settings in the highlighted menu, press the right arrow button.
4. Press the up or down arrow button to move through the settings. If there are additional settings, press the right or left arrow button as instructed on the screen.
5. To select a setting, press the **OK** button any time the **OK** button option is displayed.
6. When you finish changing settings on a menu, press the left arrow button to go back or press the **||**  pause/cancel button to completely exit the menu.

Parent topic: [Using the Control Panel Menus](#)

Maintenance Menu Settings

The Maintenance menu lets you run nozzle checks, cleaning cycles, and other maintenance operations.

Caution: Follow the instructions in the topic links below the table to use these menu settings correctly.

Setting	Options		Description	
Nozzle Check	Printless Nozzle Check		Displays the nozzle status on the LCD screen.	
	Print Check Pattern		Prints a nozzle check pattern.	
Head Cleaning	Check and Clean Nozzle		Checks the nozzle status and cleans any clogged nozzles.	
	All Nozzles		Lets you clean all or selected nozzles based on the nozzle check pattern. Select Normal cleaning first. If nozzles are still clogged, select Heavy cleaning.	
	Select Nozzles	Various colors		
Head Alignment	Paper Thickness	Paper Type	Lists supported media types.	
		Paper Thickness	Lets you set the thickness of the loaded paper.	
	Alignment	Auto	Uni-D Bi-D 5-color Bi-D All	Lets you align the print head when print results are grainy or out of focus:
		Manual	Uni-D Bi-D 2-color Bi-D All	Uni-D : when printing in one direction. Bi-D settings: when printing in both directions. If head alignment does not correct the problem, select Uni-D .

Setting	Options	Description
Adjust Cut Position	-3 to 3 mm	Lets you adjust the cutter position in increments of 0.008 inch (0.2 mm) from -0.12 to 0.12 inch (-3 to 3 mm).
Change Black Ink	Photo Blk to Matte Blk Matte Blk to Photo Blk	Lets you switch between black ink types.

Parent topic: [Using the Control Panel Menus](#)

Related tasks

[Checking the Nozzles Using the Product Control Panel](#)

[Cleaning the Print Head Using the Product Control Panel](#)

[Aligning the Print Head Automatically Using the Product Control Panel](#)

[Aligning the Print Head Manually Using the Product Control Panel](#)

[Printless Nozzle Check](#)

[Switching the Black Ink Type](#)

Paper Menu Settings

The Paper menu lets you modify settings for the current paper, or create custom paper configurations for up to 10 different types of paper.

Setting	Options	Description
Paper Type	Photo Paper	Select the loaded Epson media.
	Proofing Paper	
	Fine Art Paper	
	Matte Paper	
	Plain Paper	
	Others	
	CUSTOM PAPER	Lists the custom paper configurations that you have created.
	NO PAPER SELECTED	Select to control paper type using only your printer software settings.
Custom Paper	Paper number	Lets you create a custom configuration for the loaded media. See the next table.
Print Paper List	—	Press the OK button to print a list of custom paper settings.
Roll Paper Remaining	Remaining Paper Setup	On : Lets you track the length of roll paper remaining.
	Roll Paper Length	Sets the length of the loaded roll paper from 17 to 327 ft (5 to 99.5 m). Remaining Paper Setup must be turned On .
	Roll Length Alert	Sets the length of roll paper remaining at which the printer alerts you, from 4 to 50 ft (1 to 15 m). Remaining Paper Setup must be turned On .
Cut Sheet Remaining	Sheet Number	Displays the number of sheets loaded in the paper cassette from 10 to 990 in increments of 10.
	Sheet Number Alert	Sets the number of sheets remaining in the paper cassette for when the printer alerts you, from 1 to 50 sheets in increments of 1.

Setting	Options	Description
Roll Paper Setup	Print Page Line	Sets whether to print a page line on roll paper. Any trim line options selected in the printer driver will override this setting.
	Roll Paper Margin	Sets the top and bottom margins for printing.
	Auto Roll Feeding	Lets you leave roll paper loaded in the printer when a print job is sent using the paper cassette. After the print job is complete and a roll paper option is selected from the Paper Type menu, the loaded roll paper is fed automatically. Set to Off if using Epson UltraSmooth Fine Art Paper .
Refresh Margin	—	Lets you automatically trim the leading edge and remove any ink stains left by the previous image during borderless printing.

Custom Paper Setting options

Options	Description
Select Reference Paper	Lets you select the type of paper that is closest to the paper for which you are creating a custom paper configuration: Photo Paper Proofing Paper Fine Art Paper Matte Paper Plain Paper Others

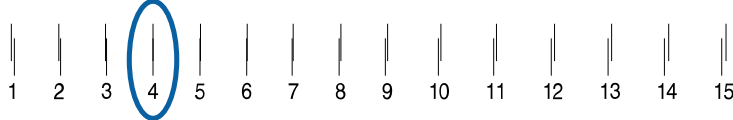
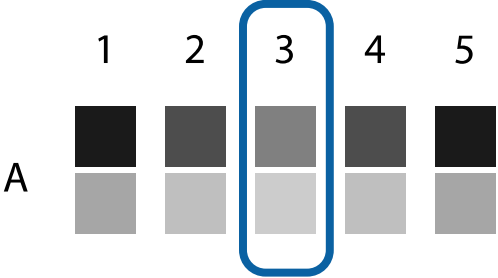
Options	Description
Platen Gap	<p>Adjusts the gap between the media and the print head.</p> <p>Standard: select for most media.</p> <p>Wide or Wider: select if printouts are smeared.</p>
Thickness Pattern	<p>When creating a custom paper configuration, lets you print patterns to determine the thickness of the custom paper:</p>  <p>Select the pattern number with the least misalignment.</p>
Paper Feed Adjust A	<p>Lets you adjust the paper feed if you are unable to resolve banding issues even after head cleaning and alignment.</p> <p>Pattern: prints an adjustment pattern that you can use to adjust the paper feed by selecting the lightest-colored pattern in each row:</p>  <p>Value: lets you choose an adjustment between -0.70 and +0.70%. Select a higher value to reduce dark bands or a lower value to reduce white bands.</p>
Paper Feed Adjust B	<p>Lets you choose an adjustment between -0.70 and +0.70% for the bottom area of cut sheets.</p>

Options	Description
Drying Time	Lets you adjust the amount of time the head pauses between each pass (from 0 seconds to 10 seconds). If the image is blurring on the paper, you may need to increase the drying time per pass.
Paper Suction	Lets you adjust the amount of suction from -4 to -1 or Standard to increase the gap between the print head and thin or soft paper. If print quality is reduced or media does not feed correctly, you may need to lower the suction.
Set Roll Paper Tension	Lets you adjust the paper tension. Select High or Extra High if paper wrinkles during printing.
Remove Skew	Lets you enable paper skew reduction.

Parent topic: [Using the Control Panel Menus](#)

Related references

[Available Epson Papers](#)

Related tasks

[Loading Roll Paper](#)

[Creating Custom Paper Configurations](#)

Related topics

[Cutting Roll Paper](#)

[Cut Sheet Handling](#)

Printer Setup Menu Settings

The Printer Setup menu lets you configure and monitor various aspects of your product.

Setting	Options	Description
Platen Gap	Narrow	<p>Adjusts the gap between the media and the print head.</p> <p>Standard: select for most media.</p> <p>Narrow: select if head alignment does not completely align the print head.</p> <p>Wide, Wider, or Widest: select if printouts are smeared.</p> <p>Caution: To avoid damaging the printer, do not select the Narrow setting when loading thick media.</p>
	Standard	
	Wide	
	Wider	
	Widest	
Paper Size Check	On	<p>Automatically detects the width of the loaded media. Choose Off only if the printer displays a paper setting error when media is loaded correctly. Changed settings take effect when you reload paper.</p> <p>Caution: Disabling this setting may cause the printer to print outside the margins of the loaded media and may cause ink to build up inside the printer.</p>
	Off	
Paper Skew Check	On	<p>Stops printing when skewed paper is detected. Leave this setting turned on to avoid paper jams.</p>
	Off	

Setting	Options		Description
Auto Nozzle Check	Auto Cleaning Setting	Periodically Every Job Off	Automatically runs a nozzle check and cleans the print head if necessary. Periodically: checks the nozzles occasionally. Every Job: checks the nozzles after every print job. Note: Even if you select Off as the Auto Cleaning Setting option, the printer runs an automatic nozzle check (and may clean the print head) when you switch between black inks and after initial ink charging.
	Auto Cleaning Times	1 to 3	Selects the number of automatic print head cleanings the printer performs when clogged nozzles are detected.
Timer Cleaning	6 to 60 hours		Performs an automatic nozzle check and head cleaning if the printer is turned on or woken from sleep mode and the printer has not printed within the set length of time.
	Off		
Print Nozzle Pattern	Every 10 Pages Every Page Off	Selects how often to print an automatic nozzle check pattern.	
Auto Black Ink Change	Manual Auto	Allows you to change the black ink type from the printer driver. Manual: an error appears on the LCD screen when the black ink type selected in the driver and in the printer control panel do not match. Auto: the black ink type is changed automatically.	

Setting	Options	Description
BK Ink Change Setting	Normal Quick	Select Quick to reduce the time it takes to change the black ink type; however, print quality is reduced when you change the ink type.
Calibration Setting	On Off	Lets you use the Epson Color Calibration Utility.
Initialize Settings	Execute	Returns all printer settings to their default values.

Parent topic: [Using the Control Panel Menus](#)

Related tasks

[Switching the Black Ink Type](#)

[Checking the Nozzles Using the Product Control Panel](#)

[Cleaning the Print Head Using the Product Control Panel](#)

[Adjusting the Platen Gap](#)

Printer Status Menu Settings

The Printer Status menu lets you display and print information about your printer.

Setting	Description
Firmware Version	Displays the printer's firmware version.
Print Status Sheet	Prints a sheet listing the current printer settings.
Calibration Date	Displays the date that the Epson Color Calibration Utility was last run, if applicable.
Total Prints	Displays the total number of pages printed since initial setup.
Print Job Information	Prints job information for the last 10 jobs saved in the printer.

Parent topic: [Using the Control Panel Menus](#)

Network Setup Menu Settings

The Network Setup menu lets you configure your printer's network settings.

Setting	Options	Description
Network Settings	Hide	Displays or hides information for the rest of the menu items.
	Show	
IP Address Setting	Auto	Determines whether IP addresses are obtained automatically through DHCP or manually. Select Panel to enter an IP address, subnet mask, and default gateway address.
	Panel	
IP, SM, DG Setting	—	Sets the IP address, subnet mask, and default gateway.
Print Status Sheet	—	Prints a sheet listing the current network status and settings.
Init Network	—	Returns all network settings to their default values.

Parent topic: [Using the Control Panel Menus](#)

Preferences Menu Settings

The Preferences menu lets you customize various display and power settings.

Setting	Options	Description
Language	Various languages	Selects the language used on the control panel display.
Length Units	Metric	Selects the unit of length used on the control panel display and when printing test patterns.
	Feet/Inch	
Temperature Units	°C	Selects the unit of temperature used on the control panel display.
	°F	

Setting	Options		Description
Maintenance Alert	Disable		No alerts are set.
	Ink		The alert light flashes when ink is low.
	Maintenance Box		The alert light flashes when Maintenance Box 1 or 2 is full.
	Ink or Maint Box		The alert light flashes when ink is low or Maintenance Box 1 or 2 is full.
	Papers		The alert light flashes when roll paper or cut sheets are running low, or when Roll Paper Remaining or Cut Sheet Remaining is set to on.
	All		The alert light flashes when ink is low, a maintenance tank is full, or paper is running low.
Cut Sheet Remaining	On		Turn on to display an alert when cut sheet level is low (set level for alert using Sheet Number Alert setting in Paper menu).
	Off		
Sleep Mode	5 to 210 minutes		Selects the interval before the printer enters sleep mode. The default is 15 minutes .
Power Management	Power Off Timer	Disable	Chooses if the printer turns off automatically when it is idle. The default idle time is 8 hours .
		Enable	
	Time to Off	1 to 24 hours	

Parent topic: [Using the Control Panel Menus](#)

Administrator Menu Settings

The Administrator Menu lets you select administrative settings and control who can access the settings.

Setting	Options	Description
Powerful Cleaning	All Nozzles	Lets you clean all or selected colors, based on the nozzle check pattern. Use this setting only if you still have clogged nozzles after running multiple head cleanings from the Maintenance menu.
	Various colors	
Clock Setting	—	Sets the printer's built-in clock. The time and date are used in logs and status sheets.
Reset All Settings	Execute	Returns all menu settings to their default values.

Parent topic: [Using the Control Panel Menus](#)

Related tasks

[Using the Powerful Cleaning Utility](#)

Replacing Ink Cartridges and Maintenance Tanks

If the **Check** ink light stays lit and the  icon appears above an ink cartridge on the LCD screen, the cartridge is expended and you need to replace it.

You may also need to replace a cartridge that is more than six months old, or if your printouts do not look their best, even after cleaning and aligning the print head.

The maintenance tank absorbs ink used in maintenance operations such as head cleaning and switching between black ink types. Your product contains two separate maintenance tanks. If the  icon appears on one of the maintenance tanks on the LCD screen, the tank is at the end of its service life and you need to replace it.

Note: Please dispose of your used Epson branded ink cartridges and maintenance tanks responsibly and in accordance with local requirements. If you would like to return your used ink cartridges and maintenance tanks to Epson for proper disposal, please go to [epson.com/recycle](https://www.epson.com/recycle) for more information.

[Checking Ink and Maintenance Tank Status with Windows](#)

[Checking Ink and Maintenance Tank Status on a Mac](#)

[Purchase Epson Ink Cartridges and Maintenance Tanks](#)

[Removing and Installing Ink Cartridges](#)

[Replacing Maintenance Tanks](#)

[Switch Black Ink Type](#)

Checking Ink and Maintenance Tank Status with Windows

You can check your ink or maintenance tank status at any time using a utility on your Windows computer.

1. To check your status, access the Windows Desktop, double-click the product icon in the Windows taskbar, and click **Details**.

You see this window:

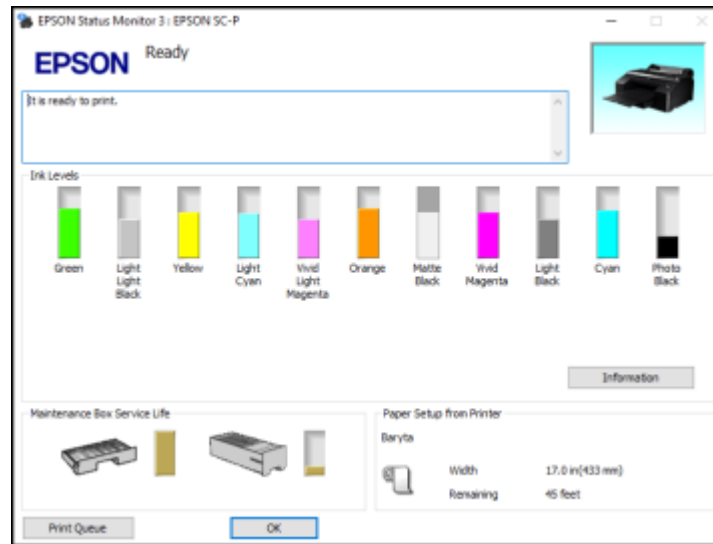

2. Replace or reinstall the maintenance tank or ink cartridge as indicated on the screen.

Note: If any of the ink cartridges installed in the product is broken, incompatible with the product model, or improperly installed, Epson Status Monitor will not display an accurate ink status.

Parent topic: [Replacing Ink Cartridges and Maintenance Tanks](#)

Related concepts

[Replacing Maintenance Tanks](#)

Related tasks

[Removing and Installing Ink Cartridges](#)

Checking Ink and Maintenance Tank Status on a Mac

You can check your ink or maintenance tank status using a utility on your Mac.

1. In the Apple menu or the Dock, select **System Preferences**. Select **Print & Fax**, **Print & Scan**, or **Printers & Scanners**, select your product, and select **Options & Supplies**. Select **Utility** and select **Open Printer Utility**.

2. Select **EPSON Status Monitor**.

You see a window like this:

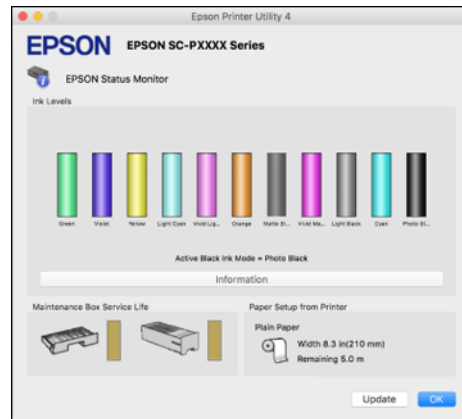

3. Do the following as necessary:

- To update the ink cartridge status, click **Update**.
- Replace or reinstall any ink cartridge or maintenance tank indicated on the screen.

Note: If any of the cartridges installed in the product is broken, incompatible with the product model, or improperly installed, Epson Status Monitor will not display an accurate cartridge status.

Parent topic: [Replacing Ink Cartridges and Maintenance Tanks](#)

Related concepts

[Replacing Maintenance Tanks](#)

Related tasks

[Removing and Installing Ink Cartridges](#)

Purchase Epson Ink Cartridges and Maintenance Tanks

You can purchase genuine Epson ink, paper, and accessories from an Epson authorized reseller. To find the nearest reseller, visit proimaging.epson.com (U.S.) or proimaging.epson.ca (Canada), select your product series and product, and click the **Where to Buy** button. Or call 800-GO-EPSON (800-463-7766) in the U.S. or 800-807-7766 in Canada.

Note: This product uses only genuine Epson-brand cartridges. Other brands of ink cartridges and ink supplies are not compatible and, even if described as compatible, may not function properly.

The cartridges included with the printer are designed for printer setup and not for resale. After some ink is used for charging, the rest is available for printing. Yields vary considerably based on images printed, print settings, paper type, frequency of use, and temperature. For print quality, a variable amount of ink remains in the cartridge after the "replace cartridge" indicator comes on.

[Ink Cartridge and Maintenance Tank Part Numbers](#)

Parent topic: [Replacing Ink Cartridges and Maintenance Tanks](#)

Ink Cartridge and Maintenance Tank Part Numbers

Use these part numbers when you order or purchase a new maintenance tank or ink cartridges.

Note: For best printing results, use up a cartridge within 6 months of opening the package.

Ink maintenance tank (maintenance box 1) part number: T6190

Borderless maintenance tank (maintenance box 2) part number: T6191

Ink bay	Slot	Ink color	Part number
Left	1	Green (G)	T913B
	2	Light Light Black (LLK) (Standard and Designer Edition only)	T9139
		Violet (V) (Commerical Edition only)	T913D
	3	Yellow (Y)	T9134
	4	Light Cyan (LC)	T9135
	5	Vivid Light Magenta (VLM)	T9136
Right	6	Orange (O)	T913A
	7	Matte Black (MK)	T9138
	8	Vivid Magenta (M)	T9133
	9	Light Black (LK)	T9137
	10	Cyan (C)	T9132
	11	Photo Black (K)	T9131

Parent topic: [Purchase Epson Ink Cartridges and Maintenance Tanks](#)

Removing and Installing Ink Cartridges

Make sure you have your replacement cartridges handy before you begin. You must install new cartridges immediately after removing the old ones.

Note: Replace all expended ink cartridges. You cannot print if any of the ink cartridges are expended or any ink slots are empty.

1. Turn on your product.
2. Press the ink cartridge cover to open it.

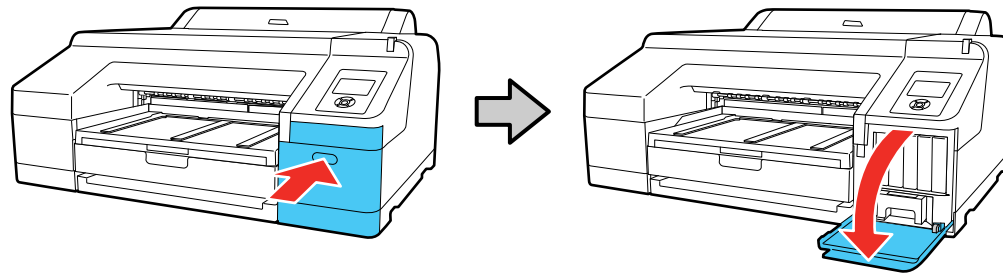

3. Press in on the ink cartridge you want to replace. The ink cartridge pops out slightly.

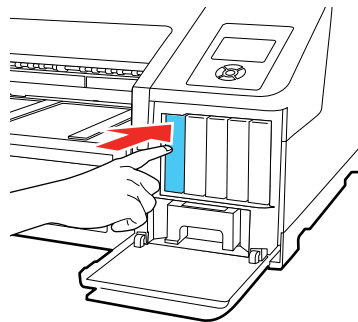

4. Pull out the ink cartridge.

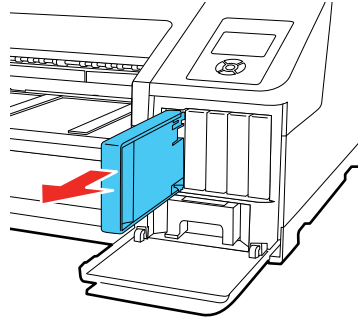

Note: Dispose of used cartridges carefully. Do not take the used cartridge apart or try to refill it.

Warning: If ink gets on your skin, wash it thoroughly with soap and water. If ink gets into your eyes, flush them immediately with water. If ink gets into your mouth, spit it out and see a doctor right away. Keep ink cartridges out of the reach of children.

5. Remove the new cartridge from the package. Then gently shake the cartridge for about 15 seconds.

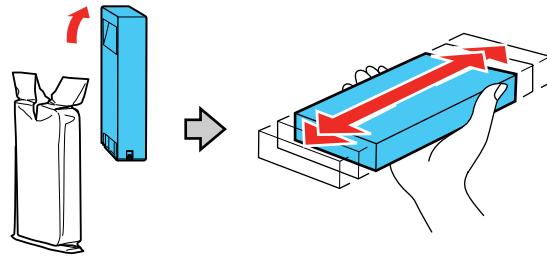

Caution: Do not touch the green chip on the cartridge.

6. Insert the new cartridge with the arrow facing up and push it in until it clicks into place.

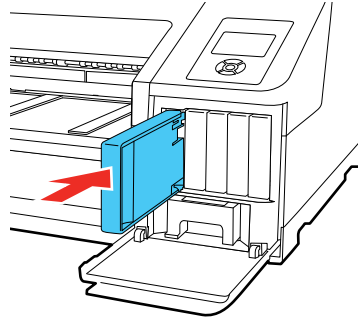

Caution: Do not remove and re-insert cartridges more often than necessary. Doing so can break the needle valve seal and allow air to enter the ink tubes, damaging the nozzles.

7. Close the ink cartridge cover and push it in until it clicks into place.

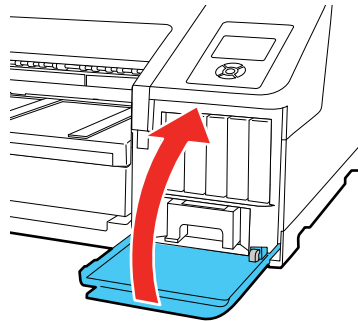

Your product begins charging the ink delivery system.

Note: Do not turn off the product during ink charging.

Caution: If you remove an ink cartridge for later use, protect the ink supply area from dirt and dust and store it in the same environment as the printer. The valve in the ink supply port is designed to contain any excess ink, but do not touch the ink supply port or surrounding area. Always store ink cartridges with the label facing up; do not store cartridges upside-down.

Note: If a cleaning cycle starts when ink is low and the level of ink remaining in the cartridge is estimated to be less than required for a cleaning, the printer will tell you that there is not enough ink to complete the process. You must insert a fuller cartridge to complete the cleaning. At the end of the cleaning, the original cartridge can be re-inserted and used until it is expended.

Parent topic: [Replacing Ink Cartridges and Maintenance Tanks](#)

Related concepts

[Purchase Epson Ink Cartridges and Maintenance Tanks](#)

Replacing Maintenance Tanks

The maintenance tank absorbs ink used in maintenance operations such as head cleaning and switching between black ink types. Your product contains two separate maintenance tanks. Replace the specified maintenance tank when you see a message on the LCD screen.

Note: Do not reuse maintenance tanks that you have removed from the product and exposed to air for a long period of time. The box will not absorb any more ink.

Note: Do not replace a maintenance tank while printing. Colors may vary and print quality may decline when printing is resumed.

[Replacing the Ink Maintenance Tank](#)

[Replacing the Borderless Maintenance Tank](#)

Parent topic: [Replacing Ink Cartridges and Maintenance Tanks](#)

Related concepts

[Purchase Epson Ink Cartridges and Maintenance Tanks](#)

Related references

[Optional Equipment and Replacement Parts](#)

Replacing the Ink Maintenance Tank

Replace the ink maintenance tank (maintenance box 1) on the right side of the printer.

1. Press the right ink cartridge cover to open it.

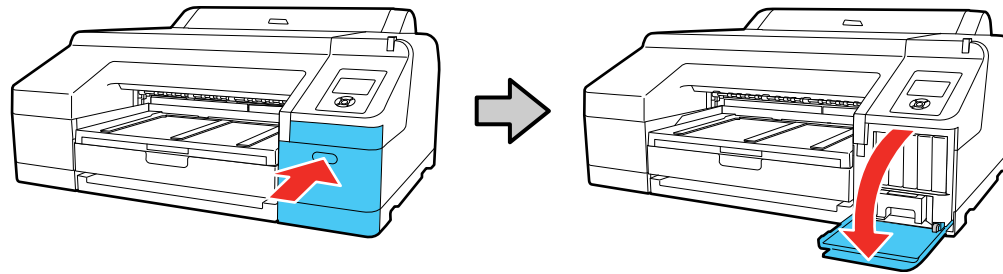

2. Use the handle on the bottom of the maintenance tank to carefully pull it out of the product without tilting the tank.

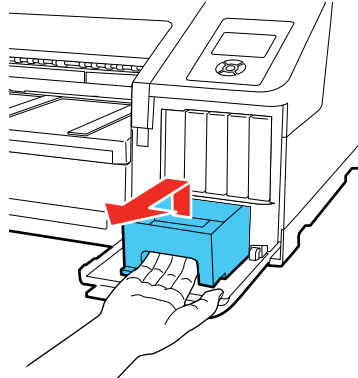

Warning: If ink gets on your skin, wash it thoroughly with soap and water. If ink gets into your eyes, flush them immediately with water. If ink gets into your mouth, spit it out and see a doctor right away.

3. Remove the new maintenance tank from the package.

Caution: Do not touch the chip on the side of the maintenance tank or you may damage the product. Do not remove the film from the top of the maintenance tank.

4. Insert the new maintenance tank in the slot.

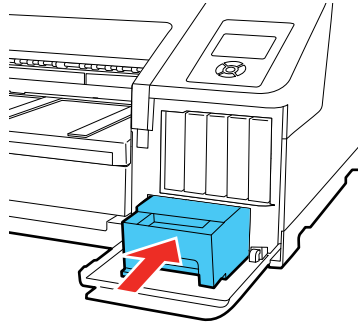

5. Place the used maintenance tank in the bag supplied with the new tank and seal the bag.

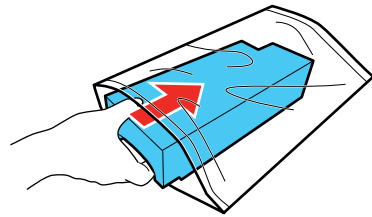

6. Close the ink cartridge cover.

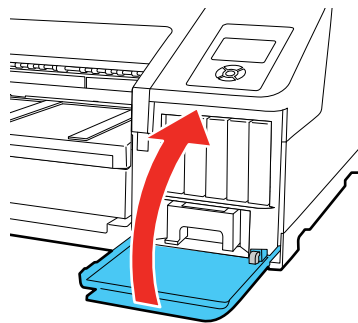

Note: Dispose of used maintenance tanks carefully.

Parent topic: [Replacing Maintenance Tanks](#)

Related concepts

[Purchase Epson Ink Cartridges and Maintenance Tanks](#)

Related references

[Optional Equipment and Replacement Parts](#)

Replacing the Borderless Maintenance Tank

Replace the borderless maintenance tank (maintenance box 2) inside the printer.

1. Lift the edge of the output tray to remove it.

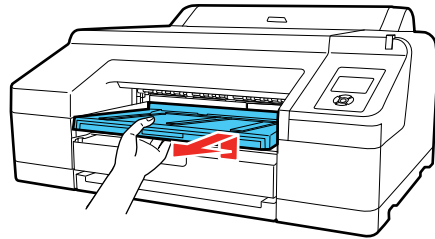

2. Move the lock lever to the unlock position.

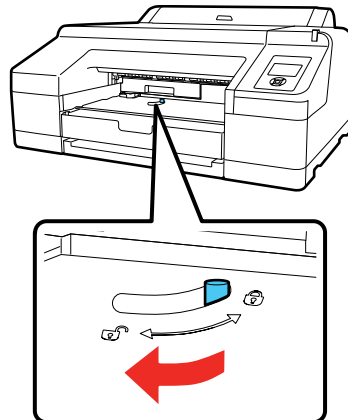

3. Use the handle on the bottom of the maintenance tank to carefully pull it out of the product without tilting the tank.

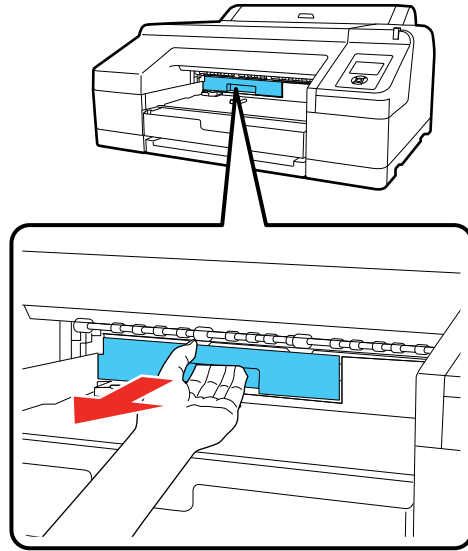

4. Remove the new maintenance tank from the package.

Caution: Do not touch the chip on the side of the maintenance tank or you may damage the product.

5. Insert the new maintenance tank and push it firmly in the slot.

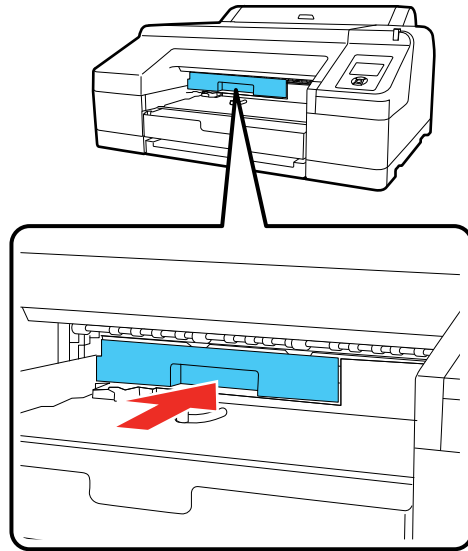

6. Place the used maintenance tank in the bag supplied with the new tank and seal the bag.

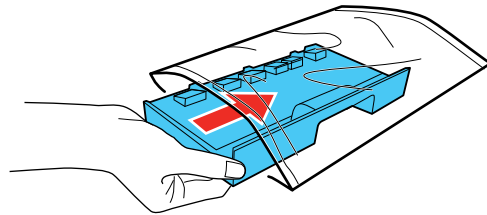

Warning: If ink gets on your skin, wash it thoroughly with soap and water. If ink gets into your eyes, flush them immediately with water. If ink gets into your mouth, spit it out and see a doctor right away.

7. Return the lock lever to the locked position.

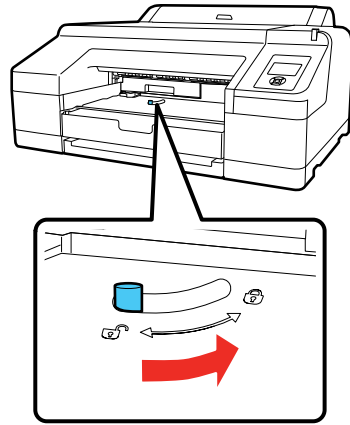

8. Replace the output tray.

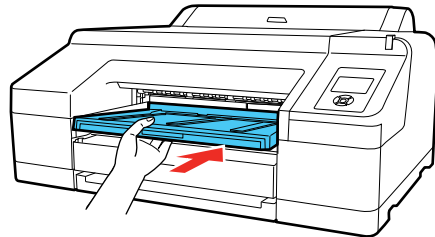

Note: Dispose of used maintenance tanks carefully.

Parent topic: [Replacing Maintenance Tanks](#)

Related concepts

[Purchase Epson Ink Cartridges and Maintenance Tanks](#)

Related references

[Optional Equipment and Replacement Parts](#)

Switch Black Ink Type

Your product comes with Matte Black and Photo Black ink cartridges. Although both cartridges must be installed for your product to work, it can print using only one type of black ink at a time.

You can switch the black ink type, depending on the type of media you load. This process consumes some ink, so you should avoid switching black ink more often than necessary and select a default black ink type for the type of media you print on most often.

Note: To enable automatic black ink switching when the black ink type setting in the printer and printer software are different, press the **Menu** button and select **Printer Setup > Auto Black Ink Change > Auto**.

[Switching the Black Ink Type](#)

[Black Ink Type Media List](#)

Parent topic: [Replacing Ink Cartridges and Maintenance Tanks](#)

Related references

[Printer Setup Menu Settings](#)

Switching the Black Ink Type

Switching the black ink type takes several minutes and consumes some ink. Check the black ink type media list to select the correct ink type for the media you loaded.

1. Press the  **Black** ink/maintenance button.
2. Press the down arrow button to select **Change Black Ink** and press the right arrow button.
3. Press the **OK** button to switch black inks.

The printer charges the black ink for a few minutes:

- Photo Black to Matte Black: about 2 minutes.
- Matte Black to Photo Black: about 4 minutes.

Parent topic: [Switch Black Ink Type](#)

Related references

[Black Ink Type Media List](#)

Black Ink Type Media List

To conserve ink, select the default black ink type that matches the type of media you usually print on.

Matte Black Ink Media Types

- Epson Presentation Paper Matte
- Epson Premium Presentation Paper Matte
- Epson Premium Presentation Paper Matte Double-sided
- Epson Ultra Premium Presentation Paper Matte
- Epson Velvet Fine Art Paper
- Epson Exhibition Watercolor Paper Textured
- Epson Watercolor Paper Radiant White
- Epson UltraSmooth Fine Art Paper 325 gsm
- Epson Exhibition Canvas Matte
- Epson Exhibition Canvas Natural Matte
- Epson Photo Quality Self-adhesive Sheets
- Epson Hot Press Bright
- Epson Hot Press Natural
- Epson Cold Press Bright
- Epson Cold Press Natural

Photo Black Ink Media Types

- Epson Photo Paper Glossy
- Epson Premium Photo Paper Glossy
- Epson Ultra Premium Photo Paper Glossy
- Epson Premium Photo Paper Semi-gloss
- Epson Ultra Premium Photo Paper Luster
- Epson Exhibition Canvas Gloss
- Epson Exhibition Canvas Satin
- Epson Exhibition Canvas Natural Satin
- Epson Exhibition Canvas Natural Gloss
- Epson Exhibition Fiber Paper
- Epson Metallic Photo Paper Glossy

- Epson Metallic Photo Paper Luster

Parent topic: [Switch Black Ink Type](#)

Related references

[Available Epson Papers](#)

Adjusting Print Quality

If your print quality declines, you may need to run a utility to clean or align the print head.

If running these utilities does not solve the problem, you may need to replace the ink cartridges.

[Print Head Maintenance](#)

[Print Head Alignment](#)

Print Head Maintenance

If your printouts become too light, or you see dark or light bands across them, you may need to clean the print head nozzles. Cleaning uses ink, so clean the nozzles only if print quality declines.

You can check for clogged nozzles before you clean them so you don't clean them unnecessarily.

Note: You cannot clean the print head if an ink cartridge is expended, and may not be able to clean it when a cartridge is low. You must replace the cartridge first.

[Print Head Nozzle Check](#)

[Print Head Cleaning](#)

[Using the Powerful Cleaning Utility](#)

Parent topic: [Adjusting Print Quality](#)

Related tasks

[Removing and Installing Ink Cartridges](#)

Print Head Nozzle Check

You can print a nozzle check pattern to check for clogged nozzles.

[Printless Nozzle Check](#)

[Checking the Nozzles Using the Product Control Panel](#)

[Checking the Nozzles Using a Computer Utility](#)

Parent topic: [Print Head Maintenance](#)

Printless Nozzle Check

You can check the status of the nozzles and determine if any of them are clogged from the control panel. If clogged nozzles are detected, you can also clean them automatically from the control panel.

1. Press the  **Black** ink/maintenance button.

2. Press the right arrow button to select **Nozzle Check**.
3. Press the **OK** button to select **Printless Nozzle Check**.
The nozzle check begins.
4. Do one of the following:
 - If there no nozzle clogs are detected, press the **OK** button to return to the main screen.
 - If a nozzle clog is detected, a message appears on the LCD screen and displays which nozzles are clogged. Press the  **Black** ink/maintenance button to begin automatic cleaning.

Note: If you select **Finish**, you risk printing that may exhibit banding from clogged nozzles. It is recommended to print a nozzle check pattern and clean nozzles as necessary before continuing to print.

Parent topic: [Print Head Nozzle Check](#)

Related references

[Maintenance Menu Settings](#)

Checking the Nozzles Using the Product Control Panel

You can check the print head nozzles using the control panel on your product.

1. Make sure roll or cut sheet paper is loaded in the printer.
2. Make sure the correct paper type is selected.
3. Press the  **Black** ink/maintenance button.
4. Press the right arrow button to select **Nozzle Check**.
5. Press the down arrow button to select **Print Check Pattern**.
6. Press the **OK** button.
The nozzle pattern prints.
7. Check the printed pattern to see if there are gaps in the lines.

Note: Use at least a 10× eye loupe to examine the pattern for any missing or deflected dots or segments.

Print head is clean

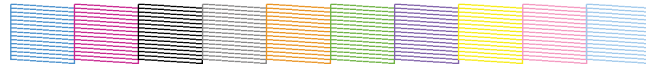

Print head needs cleaning

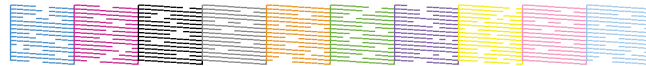

8. Do one of the following:
 - If there are no gaps, select **Exit** and press the **OK** button.
 - If there are gaps or the pattern is faint, select **Head Cleaning** and press the **OK** button.
9. Follow the instructions on the screen to clean the print head, check the nozzles, and repeat the process as necessary.

Parent topic: [Print Head Nozzle Check](#)

Related references

[Maintenance Menu Settings](#)

Related tasks

[Cleaning the Print Head Using the Product Control Panel](#)

Checking the Nozzles Using a Computer Utility

You can check the print head nozzles using a utility on your Windows or Mac computer.

1. Load roll or cut sheet paper in the printer.
2. Make sure the correct paper type is selected.
3. Do one of the following:
 - **Windows:** Access the Windows Desktop and right-click the product icon in the Windows taskbar.
 - **Mac:** In the Apple menu or the Dock, select **System Preferences**. Select **Print & Fax**, **Print & Scan**, or **Printers & Scanners**, select your product, and select **Options & Supplies**. Select **Utility** and select **Open Printer Utility**.
4. Select **Nozzle Check**.

You see a window like this:

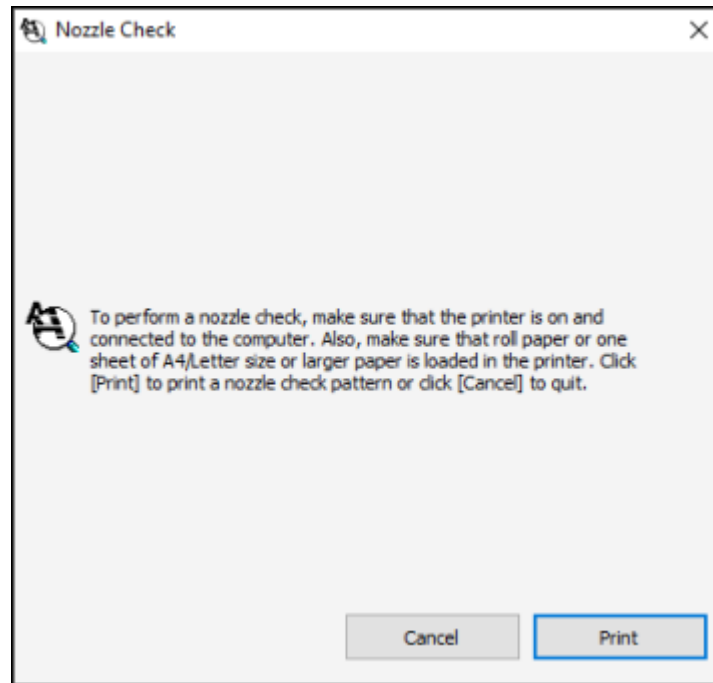

5. Click **Print**.
The nozzle pattern prints.
6. Check the printed pattern to see if there are gaps in the lines.

Note: Use at least a 10× eye loupe to examine the pattern for any missing or deflected dots or segments.

Print head is clean

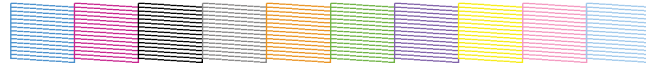

Print head needs cleaning

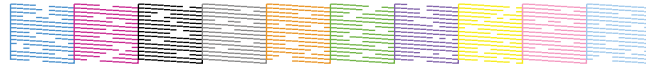

7. If there are no gaps, click **Finish**.

If there are gaps or the pattern is faint, clean the print head.

Parent topic: [Print Head Nozzle Check](#)

Related tasks

[Cleaning the Print Head Using a Computer Utility](#)

Print Head Cleaning

If print quality has declined and the nozzle check pattern indicates clogged nozzles, you can clean the print head. Use the nozzle check pattern to determine which colors need cleaning. You can save ink by cleaning only selected colors (control panel only).

Note: You cannot clean the print head if an ink cartridge is expended, and may not be able to clean it when a cartridge is low. You must replace the cartridge first.

[Cleaning the Print Head Using the Product Control Panel](#)

[Cleaning the Print Head Using a Computer Utility](#)

Parent topic: [Print Head Maintenance](#)

Cleaning the Print Head Using the Product Control Panel

You can clean the print head using the control panel on your product.

1. Make sure roll or cut sheet paper is loaded in the printer.
2. Make sure the correct paper type is selected.
3. Press the  **Black** ink/maintenance button.

4. Press the down arrow button to select **Head Cleaning** and press the right arrow button.
5. Press the up or down arrow button to select one of the following:
 - To check for clogs followed by an automatic cleaning, select **Check and Clean Nozzle** and press the right arrow button. Press the down arrow button to select **Yes** and press the **OK** button to start.
 - To select the specific nozzles for cleaning, select **Select Nozzles** and press the right arrow button. Press the up or down arrow buttons to select the color(s) that need cleaning, and press the **OK** button to start.
 - To clean all nozzles, select **All Nozzles** and press the right arrow button.
6. Select one of the following as the cleaning strength level:
 - For a first cleaning, select **Normal**.
 - If nozzles are still clogged after three normal level cleanings, select **Heavy**.
7. Press the **OK** button to start the cleaning cycle.

When the cleaning cycle is finished, the  power light stops flashing and a confirmation screen appears.

Caution: Never turn off the product during a cleaning cycle or you may damage it.

8. Select **Nozzle Check** and press the right arrow button.
9. Press the **OK** button.
The nozzle pattern prints.
10. Check the printed pattern to see if there are gaps in the lines.

Note: Use at least a 10× eye loupe to examine the pattern for any missing or deflected dots or segments.

Print head is clean

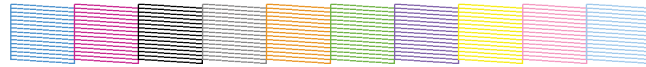

Print head needs cleaning

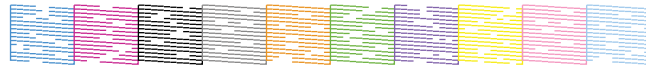

11. Follow the instructions on the screen to clean the print head, check the nozzles, and repeat the process as necessary.

If you don't see any improvement after running three **Normal** level cleanings and a **Heavy** level cleaning, you may need to perform a **Powerful Cleaning** from the Administrator menu.

Parent topic: [Print Head Cleaning](#)

Related references

[Maintenance Menu Settings](#)

[Administrator Menu Settings](#)

Related tasks

[Removing and Installing Ink Cartridges](#)

[Using the Powerful Cleaning Utility](#)

Cleaning the Print Head Using a Computer Utility

You can clean the print head using a utility on your Windows computer or Mac.

1. Make sure roll or cut sheet paper is loaded in the printer.
2. Make sure the correct paper type is selected.
3. Do one of the following:
 - **Windows:** Access the Windows Desktop and right-click the product icon in the Windows taskbar.
 - In the Apple menu or the Dock, select **System Preferences**. Select **Print & Fax**, **Print & Scan**, or **Printers & Scanners**, select your product, and select **Options & Supplies**. Select **Utility** and select **Open Printer Utility**.
4. Select **Head Cleaning**.

You see a window like this:

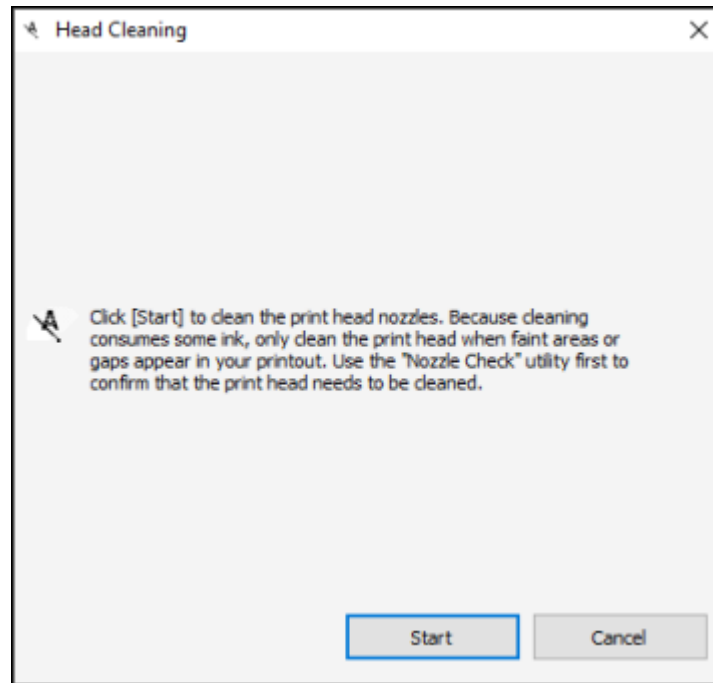

5. Click **Start** to begin the cleaning cycle.

When the cleaning cycle is finished, the  power light stops flashing and a confirmation screen appears.

Caution: Never turn off the product during a cleaning cycle or you may damage it.

6. Click **Nozzle Check**.

7. Click **OK**.

The nozzle pattern prints.

8. Check the printed pattern to see if there are gaps in the lines.

Note: Use at least a 10× eye loupe to examine the pattern for any missing or deflected dots or segments.

Print head is clean

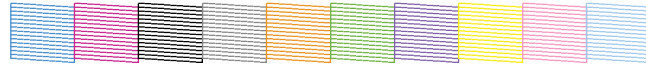

Print head needs cleaning

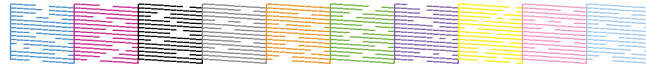

If you don't see any improvement after running a nozzle check from the computer utility, then run a **Heavy** level cleaning from the product's control panel. If you still don't see any improvement, you may need to perform a **Powerful Cleaning** from the Administrator menu.

Parent topic: [Print Head Cleaning](#)

Related tasks

[Removing and Installing Ink Cartridges](#)

[Using the Powerful Cleaning Utility](#)

Using the Powerful Cleaning Utility

If print head nozzles are still clogged after running three **Normal** cleanings and one **Heavy** cleaning, you should run a **Powerful Cleaning** using the control panel on your product. This process consumes a lot of ink.

1. Make sure roll or cut sheet paper is loaded in the printer.
2. Make sure the correct paper type is selected.
3. Press the **Menu** button.
4. Press the down arrow button to select **Administrator Menu** and press the right arrow button.
5. Press the right arrow button to select **Powerful Cleaning**.
6. Press the up or down arrow button to select one of the following:
 - To clean all nozzles, select **All Nozzles** and press the right arrow button.
 - To select specific nozzles for cleaning, select one of the nozzle color combinations and press the right arrow button.

7. Press the down arrow button to select **Yes** to start the cleaning. The cleaning can take up to 37 minutes.

8. Press the **OK** button to start the cleaning cycle.

When the cleaning cycle is finished, the  power light stops flashing and a confirmation screen appears.

Caution: Never turn off the product during a cleaning cycle or you may damage it.

9. Print another nozzle check pattern to view the results of the cleaning.

If nozzles are still clogged, turn off the printer and leave it off overnight. If nozzles are still clogged after some time, contact Epson for support.

Parent topic: [Print Head Maintenance](#)

Related references

[Administrator Menu Settings](#)

Related tasks

[Checking the Nozzles Using the Product Control Panel](#)

[Cleaning the Print Head Using the Product Control Panel](#)

Print Head Alignment

If your printouts become grainy or blurry, you notice misalignment of vertical lines, or you see dark or light horizontal bands, you may need to align the print head.

Before you align the print head, note the following:

- Alignment varies depending on the loaded media. Align the print head using the media on which you want to print and select the correct paper type as the **Paper Type** setting.
- Run a nozzle check before you align the print head. If there are any gaps in the nozzle check pattern, clean the print head.

[Aligning the Print Head Automatically Using a Computer Utility](#)

[Aligning the Print Head Automatically Using the Product Control Panel](#)

[Aligning the Print Head Manually Using the Product Control Panel](#)

Parent topic: [Adjusting Print Quality](#)

Related concepts

[Print Head Nozzle Check](#)

Print Head Cleaning

Aligning the Print Head Automatically Using a Computer Utility

You can automatically align the print head using a utility on your Windows computer or Mac.

1. Load roll paper or cut sheet paper in this size or larger: A4 (8.3 × 11.7 inches [210 × 297 mm]).
2. Make sure the correct paper type and paper thickness are selected. You cannot use plain paper or transparent or colored paper for automatic print head alignment.
3. Do one of the following:
 - **Windows:** Access the Windows Desktop and right-click the product icon in the Windows taskbar.
 - **Mac:** In the Apple menu or the Dock, select **System Preferences**. Select **Print & Fax**, **Print & Scan**, or **Printers & Scanners**, select your product, and select **Options & Supplies**. Select **Utility** and select **Open Printer Utility**.
4. Select **Print Head Alignment**.

You see a window like this:

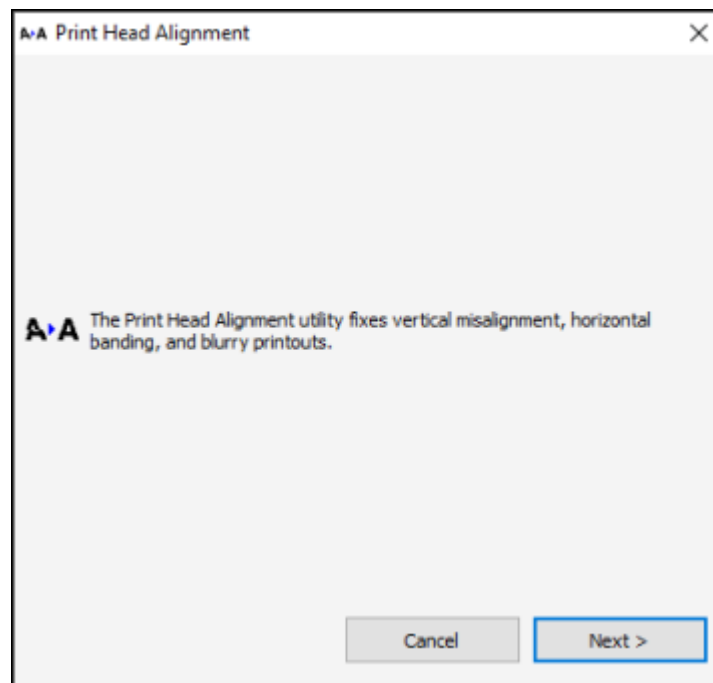

5. Click **Next**, then click **OK** to begin automatic print head alignment.

If your product is not properly aligned, perform a manual head alignment on the printer's control panel.

Parent topic: [Print Head Alignment](#)

Aligning the Print Head Automatically Using the Product Control Panel

You can automatically align the print head using the control panel on your product. Make sure no external light or direct sunlight is entering the printer when performing print head alignment.

1. Load roll paper or cut sheet paper in this size or larger: A4 (8.3 × 11.7 inches [210 × 297 mm]).
2. Make sure the correct paper type and paper thickness are selected. You cannot use plain paper or transparent or colored paper for automatic print head alignment.
3. Press the  **Black** ink/maintenance button.
4. Press the down arrow button to select **Head Alignment** and press the right arrow button.
5. Press the down arrow button to select **Alignment** and press the right arrow button.
6. Select **Auto** and press the right arrow button.
7. Press the up or down arrow button to select one of the following options:
 - **Uni-D** aligns each color for uni-directional printing based on Light Cyan.
 - **Bi-D All** aligns each color for bi-directional printing based on all colors.
8. Press the **OK** button.

The alignment process starts.

Note: Do not open the front cover or turn off the printer during the alignment process.

If your product is not properly aligned, select a different alignment method and repeat the process. If your printer still is not properly aligned, perform a manual head alignment.

Parent topic: [Print Head Alignment](#)

Related references

[Maintenance Menu Settings](#)

Aligning the Print Head Manually Using the Product Control Panel

You can manually align the print head using the control panel on your product if you are not satisfied with the automatic print head alignment results.

1. Load roll paper or cut sheet paper in this size or larger: A4 (8.3 × 11.7 inches [210 × 297 mm]).
2. Make sure the correct paper type and paper thickness are selected. Use plain paper or transparent or colored paper for manual print head alignment.
3. Press the  **Black** ink/maintenance button.
4. Press the down arrow button to select **Head Alignment** and press the right arrow button.
5. Press the down arrow button to select **Alignment** and press the right arrow button.
6. Select **Manual** and press the right arrow button.
7. Press the up or down arrow button to select one of the following options:
 - **Uni-D** aligns each color for uni-directional printing based on Light Cyan. You should choose this option first.
 - **Bi-D 2-color** aligns each color for bi-directional printing based on Light Cyan and Vivid Light Magenta. You should choose this option second.
 - **Bi-D All** aligns each color for bi-directional printing based on all colors. You should choose this option last if you are not satisfied with the previous adjustment results .
8. Press the **OK** button.

The alignment sheet prints.

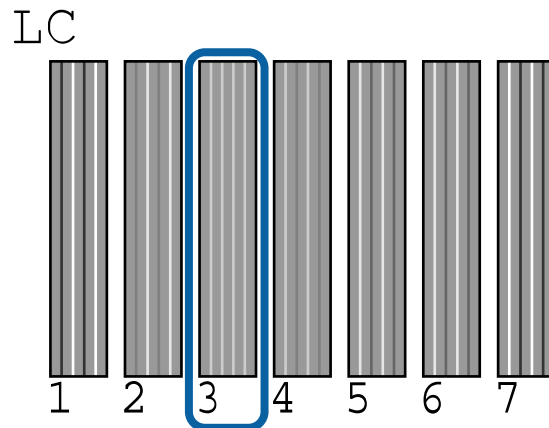

Note: When aligning on cut sheet paper, the alignment sheet is printed across multiple pages. Once the first sheet prints, load the next piece of paper.

9. After each alignment sheet is printed, view the LCD screen for instructions on selecting the best pattern in each pattern set.
10. Check the printed patterns and choose the number representing the pattern in which the white lines are the most evenly spaced, then press the **OK** button.

If your product is not properly aligned, select a different alignment method and repeat the process.

Parent topic: [Print Head Alignment](#)

Related references

[Maintenance Menu Settings](#)

Maintenance and Transportation

See the instructions in these sections to maintain your printer for optimum results, or to move or transport your printer.

[Cleaning Your Product](#)

[Replacing the Cutter](#)

[Moving or Transporting Your Product](#)

Cleaning Your Product

To keep your product working at its best, you should clean it regularly (about once a month).

Note: Do not use a hard brush, benzene, alcohol, or paint thinner to clean the product or you may damage it. Do not use oil or other lubricants inside the product or let water get inside.

1. Turn off the product.
2. Unplug the power cable.
3. Disconnect any connected cables.
4. Remove any paper from the product.
5. Open the printer cover and carefully clean the inside of the product with a soft, clean cloth.

6. Gently wipe the light blue areas in the direction indicated by the arrow.

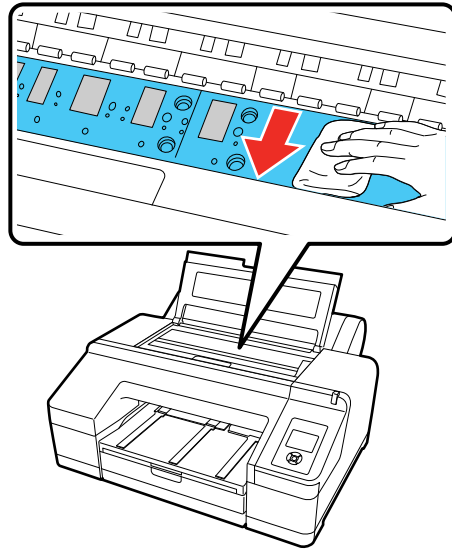



Note: Do not touch the gray areas (the rollers or the ink absorption pads) or your prints may be soiled.

Caution: Be careful not to touch the ink tubes inside the product.

7. If your product is still dirty, dampen the cloth with a small amount of water and a mild detergent and repeat the previous step. Then wipe the inside of the printer with a soft, dry cloth.

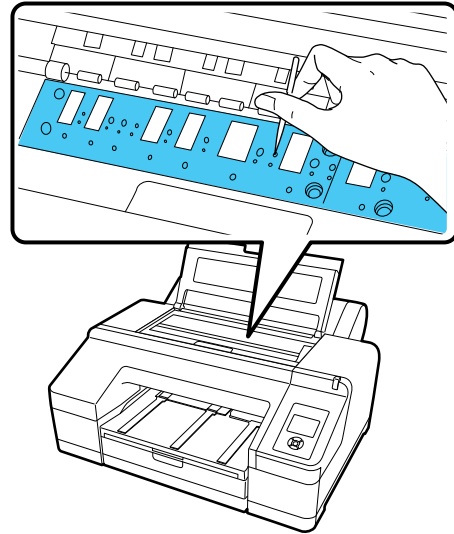
8. If paper particles have accumulated in the holes on the platen, use a toothpick or similar tool to push them through.



9. Close the printer cover.
10. Use a soft, clean cloth to remove any dust or dirt from the outside of the product.
11. Plug the power cord and interface cables back in.
12. Turn on the product.
13. Load roll paper in the printer.
14. Press the  paper feed button several times to feed blank paper through the paper path and clean the rollers.
15. Press the  paper cut button.



[Cleaning the Roll Paper Feed Slot](#)

Parent topic: [Maintenance and Transportation](#)

Cleaning the Roll Paper Feed Slot

To keep your product working at its best, you should clean the roll paper feed slot once a year using a cleaning sheet.

You can purchase genuine Epson ink, paper, and accessories from an Epson authorized reseller. To find the nearest reseller, visit proimaging.epson.com (U.S.) or proimaging.epson.ca (Canada), select your product series and product, and click the **Where to Buy** button. Or call 800-GO-EPSON (800-463-7766) in the U.S. or 800-807-7766 in Canada.

1. Turn on the printer.
2. Press the  paper source button on the control panel to select **Paper Type**.
3. Press the up or down arrow button to select **Roll Paper/Cut** or **Roll Paper/No Cut**, and press the **OK** button.
4. Press the  load paper button.
5. Open the roll paper cover. Remove the roll paper, if necessary.

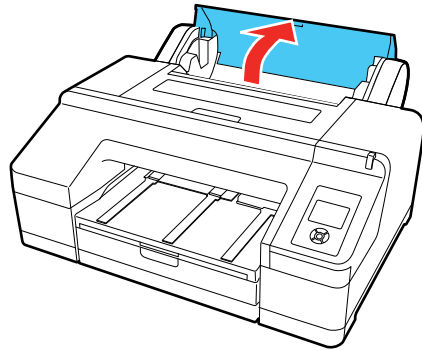

6. Remove the protective film from the cleaning sheet.

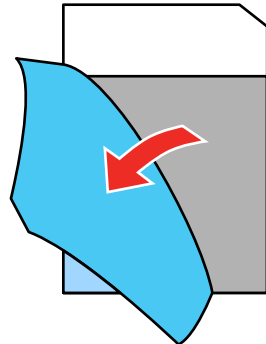

Note: Do not touch the adhesive on the sheet (the dark gray area).

7. With the adhesive facing toward you, insert the cleaning sheet on the left side of the printer until it reaches the end of the roll paper feed slot, then pull it out. Repeat this two to three times. Repeat for the center and right side of the roll paper feed slot.

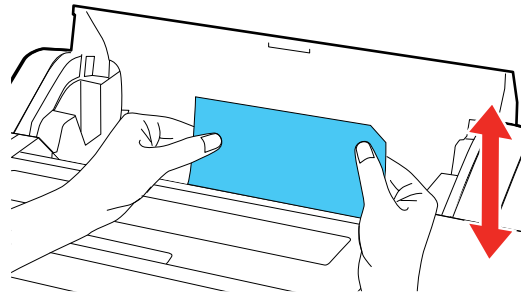

Note: You can use a cleaning sheet only once.

8. Press the  load paper button when complete.

Parent topic: [Cleaning Your Product](#)

Related references

[Optional Equipment and Replacement Parts](#)

Replacing the Cutter

If you notice that your paper does not cut cleanly, you may need to replace the cutter.

Note: If the optional SpectroProofer is installed, remove it before replacing the cutter. See the instructions that came with the SpectroProofer for details on removing it from your printer.

1. Remove any paper from the printer.

2. Open the left and right ink cartridge covers.

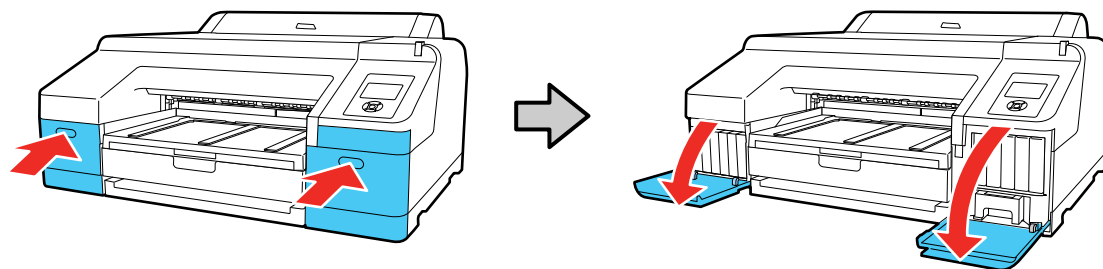

3. Open the printer cover.

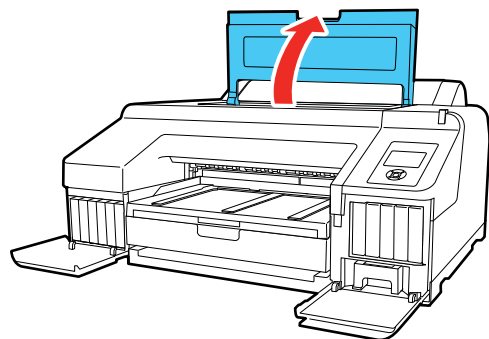

4. Use a Phillips-head screwdriver to remove the four screws securing the front cover, then remove the front cover.

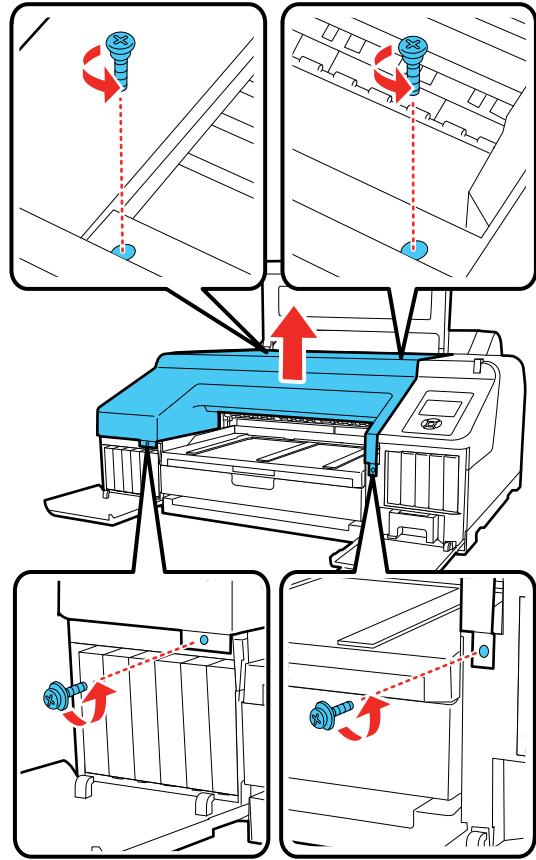

5. Press in on the tab on the cutter cover, release it, and pull down on the cutter cover to open it.

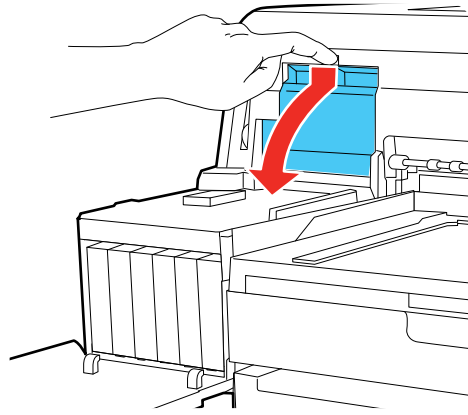

6. Loosen the screw holding the cutter in place and carefully remove the cutter.

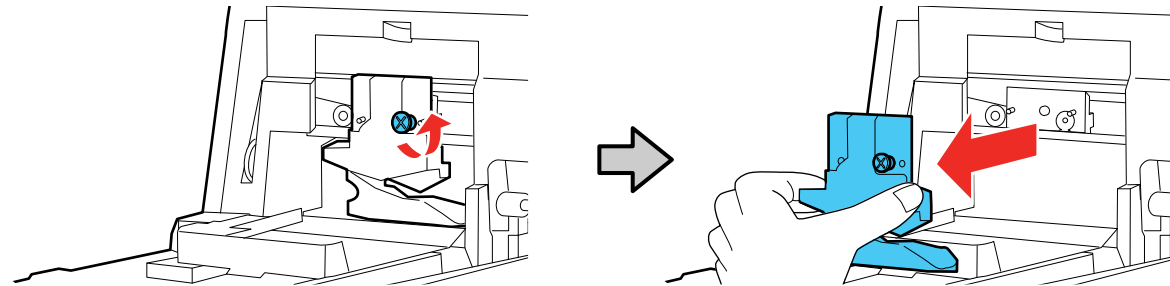

Warning: Keep the cutter out of the reach of children. The blade is sharp and can cause injury.

7. Align the pin on the new cutter with the hole in the product and insert it. Tighten the cutter screw securely.

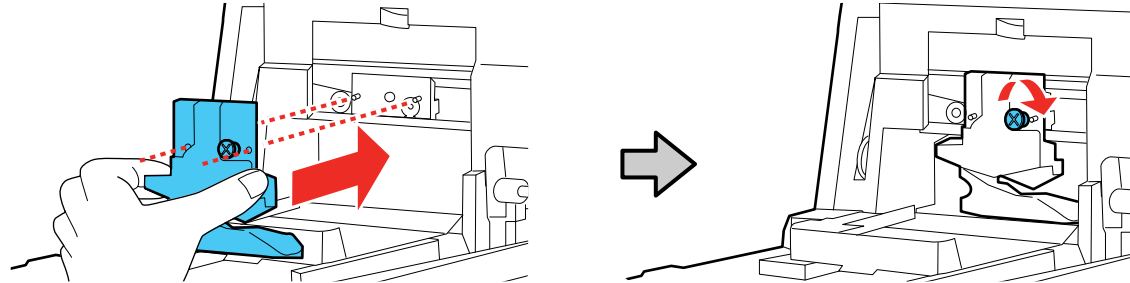

8. Close the cutter cover as shown and press it in until it clicks into place.

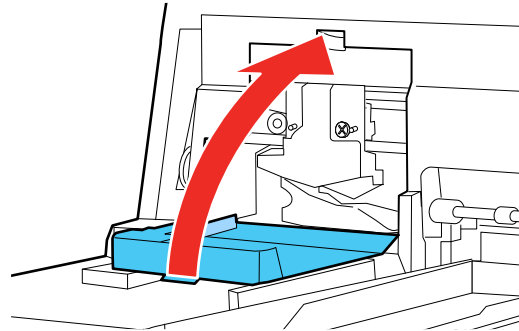

Note: If you removed the optional SpectroProofer, reinstall it. See the instructions that came with the SpectroProofer for details on installing it.

9. Replace the front cover. Insert and tighten the four screws.

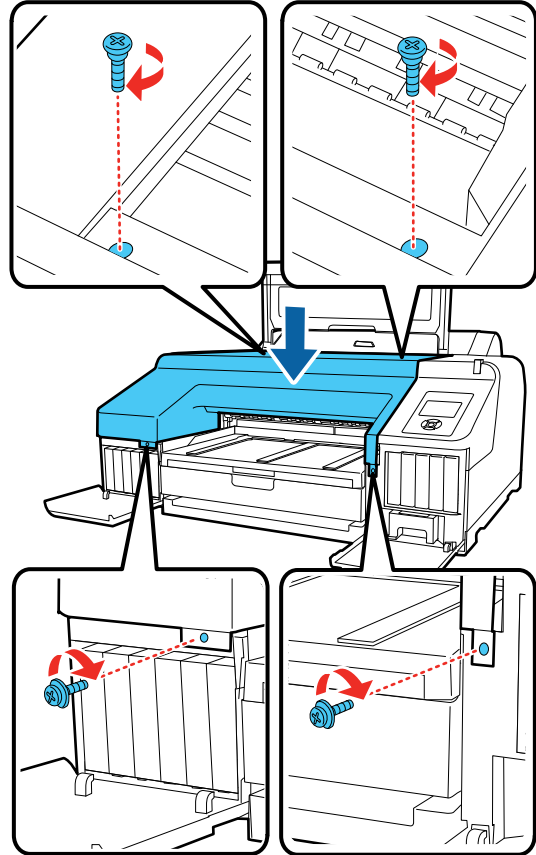

10. Close the printer cover.
11. Close the left and right ink cartridge covers.

Parent topic: [Maintenance and Transportation](#)

Related references

[Optional Equipment and Replacement Parts](#)

Moving or Transporting Your Product

If you need to move or transport your product, prepare it as described here.

Caution: During transportation and storage, follow these guidelines:

- Avoid tilting the product, placing it vertically, or turning it upside down; otherwise ink may leak.
- Leave the ink cartridges installed. Removing the cartridges can dry out the print head and may prevent the product from printing, or ink may leak.

Note: Before storing your product for a long period, replace low, expended, or expired ink to help prevent the print head from drying out. Store your product in a cool, dry place.

1. Turn off the product.
2. Unplug the power cable.
3. Disconnect any connected cables.
4. Remove all the paper from the product.

5. Have two people lift the printer by placing their hands in the indentations on the left and right sides as shown.

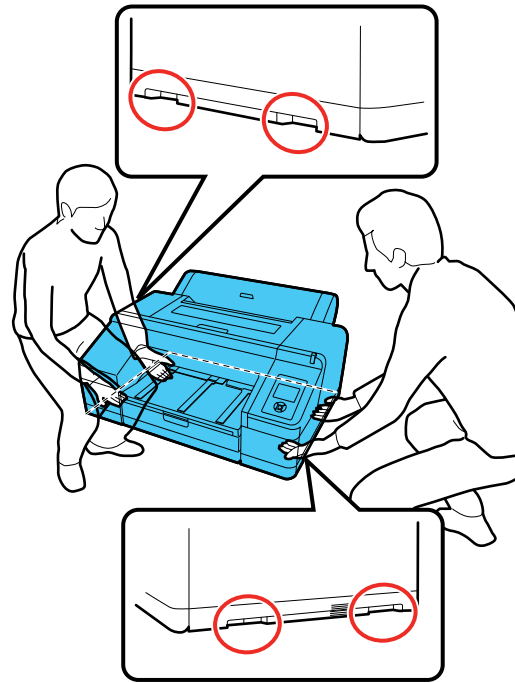

Warning: This product is heavy and requires two people to move it.

6. Place the product in its original packing materials, if possible, or use equivalent materials with cushioning around the product. Make sure the box adequately protects the product control panel.

Keep the product level during transportation. If print quality has declined when you print again, clean and align the print head.

Parent topic: [Maintenance and Transportation](#)

Related concepts

[Print Head Alignment](#)

[Print Head Cleaning](#)

Solving Problems

Check these sections for solutions to problems you may have using your product.

[Product Status Messages](#)

[Solving Printer Problems](#)

[Solving Printing Problems](#)

[Solving Paper Problems](#)

[Solving Print Quality Problems](#)



[Where to Get Help](#)



Product Status Messages







You can often diagnose problems with your product by checking the messages on the LCD screen.

LCD screen message	Condition/solution
Ink Cartridge Error Replace ink cartridge(s).	The ink cartridges have a problem. <ul style="list-style-type: none">• Check that the cartridge is the same color as the color displayed on the control panel and ink door label, and reinstall the cartridge. If the message persists, insert a new ink cartridge.• You cannot change the ink configuration (Standard or Commercial edition) after the ink cartridges have been installed. Make sure the correct cartridges are installed.• Condensation may have occurred in the ink cartridge. Remove the cartridge, leave it for four hours or more at room temperature, and reinstall it.
Ink Cartridge Expended Replace ink cartridge.	Replace the ink cartridge with a new one.
Ink Cartridge Alert Please use genuine Epson ink cartridges.	Replace the ink cartridge with a genuine Epson ink cartridge that can be used with this printer.

LCD screen message	Condition/solution
Ink Cartridge Alert Non-genuine cartridge! Quality of non-genuine ink may vary.	Select Decline to replace the ink cartridge with a genuine Epson ink cartridge that can be used with this printer. Selecting Accept may void Epson's warranty.
Ink Cartridge Error Please install the correct ink cartridge.	Replace the ink cartridge with an ink cartridge that can be used with this printer.
No Ink Cartridges Install ink cartridge(s).	Install ink cartridges.
Ink Low	The ink is low. Make sure you have a replacement ink cartridge handy.
Cutter unit nearing end of service life. Recommend replacing the cutter unit.	Paper cutter may be becoming dull. Replace the cutter.
Cartridge Cover Open Close left or right cartridge cover.	Close the specified ink cartridge cover.
Paper Load Error	Follow the instructions displayed on the LCD screen to remove the jammed paper and clear the error.
Paper Load Error Press the $\frac{1}{2}$ load paper button and reset roll paper.	Press the $\frac{1}{2}$ load paper button to rewind the roll paper, then reload it into the printer.
Paper Eject Error Remove paper from printer.	Press the $\frac{1}{2}$ load paper button to release the pressure roller, then remove the paper.
Paper Cut Error Remove uncut paper.	Roll paper is not cut correctly. Press the $\frac{1}{2}$ load paper button to release the pressure roller, then remove the uncut paper.

LCD screen message	Condition/solution
<p>Paper Size Error Load correct paper size.</p>	<p>The loaded paper is not a supported width. Press the  load paper button to release the pressure roller, then remove the paper.</p> <p>If the message still appears when you have loaded paper in a supported width, set the Paper Size Check setting to Off.</p>
<p>Paper Sensor Error Loaded paper or print out has a problem.</p>	<p>The loaded paper is not detected correctly by the printer.</p> <p>Press the  pause/cancel button.</p> <p>If this error appears while performing an automatic head alignment, check the following:</p> <ul style="list-style-type: none"> • Make sure you that you have not loaded transparent or colored media, tracing paper, plain paper, Epson Enhanced Matte Posterboard, or paper that is more than 0.04 inch (1 mm) thick. • Make sure the printer is not exposed to direct, bright light (such as direct sunlight) while performing an automatic print head alignment. • Run a nozzle check and make sure the print head nozzles are not clogged. <p>If this error appears at any other time, make sure that the printer supports the loaded media.</p>
<p>Paper Low</p>	<p>The roll paper is low. Make sure you have a replacement roll handy.</p>
<p>Paper Source Error Cut sheet is loaded. Remove it and change paper source to roll paper.</p>	<p>Press the OK button to clear the message. Remove the cut sheets from the printer and change the source in the Paper Type menu.</p>
<p>Paper Source Error Roll paper is loaded. Remove it and change paper source to cut sheet.</p>	<p>Press the OK button to clear the message. Remove the roll paper from the printer and change the source in the Paper Type menu. When Auto Roll Feeding is set to Off, you cannot change the paper type when roll paper is fed through the printer.</p>
<p>Paper Setting Error Check the paper source in your driver settings or reload paper correctly.</p>	<p>The paper source setting in the printer driver and in the printer's Paper Type menu setting do not match. Check the loaded paper and settings in the driver and printer menus.</p>

LCD screen message	Condition/solution
<p>Paper Setting Error</p> <p>This paper cannot be loaded from paper cassette. Insert paper less than 0.8 mm thickness from rear manual feeder.</p>	<p>Press the II  pause/cancel button and select Job Cancel, then remove the paper from the paper cassette. Print using the front or rear manual feeder, depending on the paper thickness.</p>
<p>Paper Setting Error</p> <p>Roll paper is loaded. Remove it and change paper source to roll paper.</p>	<p>Pull out the roll paper and select a roll paper option from the Paper Type menu.</p>
<p>Paper Skew</p> <p>Load paper properly.</p>	<p>The paper is not loaded straight. Press the  load paper button to release the pressure roller, then load the paper correctly.</p>
<p>Borderless Error</p> <p>Load a supported paper size or load paper correctly.</p>	<p>Check the following:</p> <ul style="list-style-type: none"> • Press the II  pause/cancel button and select Job Cancel, then eject the paper. Load the correct size of paper. • Make sure the paper is not wavy or curled. • Load paper in the correct position depending on the paper type. • Change the Paper Size Check setting to On.
<p>Cleaning Error</p> <p>Not enough ink. Continue cleaning?</p>	<p>Select Yes. Replace any ink cartridges with low ink with new ones to continue cleaning. After cleaning, you may reinstall the original cartridge and use it until it is expended.</p>
<p>Nozzle Clog Detected</p> <p>Not enough ink. Continue cleaning?</p>	
<p>Cleaning Error</p> <p>Automatic head cleaning failed. Retry?</p>	<p>The printer nozzles are still clogged even after running the automatic head cleaning. Select Yes to run another automatic head cleaning.</p>

LCD screen message	Condition/solution
Cleaning Error Not enough empty space in maint box 1. Continue cleaning?	Select Yes . Replace the maintenance tank (in the ink cartridge compartment) with a new one to continue cleaning.
Nozzle Clog Detected Not enough empty space in maint box 1. Continue cleaning?	
Ink Too Low To Clean Replace ink cartridge. The cartridge being used can be installed again for printing.	This message may be displayed when Yes is selected after a cleaning error or nozzle clog error. Replace any ink cartridges with low ink with new ones.
Black Ink Error Black ink does not match print job. To cancel printing, press II •  pause/cancel button. To change black ink to print, press  /  Black ink/maintenance button.	The type of black ink that is set on the printer and in the printer driver does not match. Press the  /  button to switch to the black ink type specified in the printer driver to continue printing. This takes approximately 3 minutes, and some extra black ink is consumed. Do not switch the black ink unless necessary.
Command Error Check driver settings.	The printer driver sent an invalid or incorrect command to the printer. Press the II •  pause/cancel button and select Job Cancel . Make sure that the driver you are using supports your product.

LCD screen message	Condition/solution
Check and Clean Nozzle This feature is not available now. Print the check pattern in the nozzle check menu.	Press the OK button to clear the message. Select Print Check Pattern from the Maintenance menu.
Printless Nozzle Check This feature is not available now. Print the check pattern in the nozzle check menu.	
No Maintenance Box 1 (or 2) Install Maintenance box 1 (or 2).	Make sure the indicated maintenance tank is installed correctly.
Maintenance Box Error Replace the maintenance box 1 (or 2).	Make sure the indicated maintenance tank is installed correctly. If you continue to see this message, you may need to replace the maintenance tank with a new one.
Replace Maint Box 1 At the end of service life. Replace maint box 1.	Replace the ink maintenance tank in the ink cartridge compartment (maintenance box 1) with a new one.
Not Enough Empty Space Replace the maintenance box 1.	
Replace Maint Box 2 To continue borderless printing, replace maint box 2.	Replace the borderless maintenance tank inside the printer (maintenance box 2) with a new one to perform borderless printing.
Maint Box 2 Unlocked Lock lever for maintenance box 2.	Make sure the lever for the borderless maintenance tank inside the printer (maintenance box 2) is in the lock position.

LCD screen message	Condition/solution
SpectroProofer Error See documentation for how to solve the problem. (error code)	See the SpectroProofer documentation for details on the displayed error code.
SpectroProofer Error Connect cable of SpectroProofer then restart printer.	Turn off the printer and make sure the SpectroProofer mounter is connected correctly. Wait a moment, then turn on the printer again. See the SpectroProofer mounter documentation for details.
SpectroProofer Error Refer to the manual and connect the ILS to SpectroProofer. Turn the printer power off, and then on again.	Turn off the printer and remove the color measurement device from the SpectroProofer. Reinstall it correctly, then turn on the printer again. See the SpectroProofer UVS documentation for details.
F/W Install Error Firmware update failed. Restart the printer.	The firmware updated did not install. Turn off the printer, wait for awhile, and turn on the printer again. Run the firmware update again. If the message still appears, contact Epson for support.
Maintenance Request Replace Part Soon/Replace Part Now (maintenance request code)	A part used in the printer is nearing the end of its service life. Contact Epson for support and provide them with the displayed maintenance request code. The error persists until you replace the requested part.

LCD screen message	Condition/solution
<p>Call For Service (service code)</p> <p>Power off and then on. If this doesn't work, note the code and call for service.</p>	<p>A call for service occurs when:</p> <ul style="list-style-type: none"> • The power cable is not connected securely • An error occurs that cannot be cleared <p>When a call for service has occurred, the printer automatically stops printing. Turn off the printer, disconnect the power cable from both the outlet and the printer, and reconnect them. Turn the printer on and off several times. If the same call for service is displayed on the LCD screen, contact Epson for support and provide them with the displayed service code.</p>

Parent topic: [Solving Problems](#)

Related concepts

[Print Head Nozzle Check](#)

[Print Head Cleaning](#)

Related references

[Print Quality Options - Windows](#)

[Color Management Options - Windows](#)

[Output Resolution Settings - Mac](#)

[Advanced Color Settings - Mac](#)

[Paper Menu Settings](#)

[Printer Setup Menu Settings](#)

[Administrator Menu Settings](#)

[Where to Get Help](#)

Related tasks

[Removing and Installing Ink Cartridges](#)

Related topics

[Media Handling](#)

[Replacing Ink Cartridges and Maintenance Tanks](#)

Solving Printer Problems

Check these sections if you have problems operating your product.

[Printer Does Not Turn On](#)

[LCD Screen Shuts Off](#)

Parent topic: [Solving Problems](#)

Printer Does Not Turn On

If the printer does not turn on, try these solutions:

- Make sure the power cable is securely connected.
- Make sure the power outlet works by connecting the power cable for another electronic device.

Parent topic: [Solving Printer Problems](#)

LCD Screen Shuts Off

If the LCD screen shuts off intermittently, the printer may be in Sleep Mode. Try these solutions:

- Press any of the buttons on the control panel to exit sleep mode.
- You can adjust the delay time before the product enters sleep mode in the Preferences menu.

Parent topic: [Solving Printer Problems](#)

Related references

[Preferences Menu Settings](#)

Solving Printing Problems

Check these sections if you have problems printing with your product.

[Nothing Prints](#)

[Cannot Print Over a Network](#)

[Print Head Moves But Nothing Prints](#)

Parent topic: [Solving Problems](#)

Nothing Prints

If you have sent a print job and nothing prints, try these solutions:

- Make sure your printer is turned on and in **Ready** mode.
- Make sure any interface cables are connected securely at both ends. If you have a spare cable, try connecting with the spare cable.
- Check the model and specifications of the interface cable to see if the cable is appropriate for your computer and printer.

- If you connected your printer to a USB hub, make sure it is a first-tier hub. If it still does not print, connect your printer directly to your computer instead of the hub.
- Make sure the USB hub is recognized correctly on the computer. Disconnect all USB hubs from the computer and connect the printer directly to the computer's USB port.
- Make sure the USB cable length does not exceed 10 feet (3 m).

Parent topic: [Solving Printing Problems](#)

Related references

[Interface Specifications](#)

Cannot Print Over a Network

If you cannot print over a network, try these solutions:

- Make sure that your printer is turned on.
- If you are using TCP/IP, make sure the printer's IP address is set correctly for your network. If your network does not assign IP addresses using DHCP, set the IP address manually.
- Check your wired LAN router or access point to see if the LED for the port to which your printer is connected is on or flashing. If the link LED is off, try the following:
 - Make sure the Ethernet cable is securely connected to your printer and to your router, access point, switch, or hub.
 - Try connecting your printer to a different port or a different router, access point, switch, or hub.
 - Try connecting with a different Ethernet cable.
 - Try printing to your printer from another computer on the network.
- If you have the optional SpectroProofer installed, verify its status shows as calibrated and backing color display is white.

Parent topic: [Solving Printing Problems](#)

Related references

[Network Setup Menu Settings](#)

[Interface Specifications](#)

Print Head Moves But Nothing Prints

If the print head is moving and nothing prints, try these solutions:

- Print a nozzle check pattern. If the pattern does not print correctly, clean the print head again. (If the printer has not been used for a long time the nozzles may be clogged.)

- If you see the message **Motor Self Adjustment** on the product's LCD screen, the printer is adjusting its internal motor. Wait a few moments for the message to disappear and do not turn off the printer.

Parent topic: [Solving Printing Problems](#)

Related concepts

[Print Head Nozzle Check](#)

[Print Head Cleaning](#)

Solving Paper Problems

Check these sections if you have problems using paper with your product.

[Paper Feeding Problems](#)

[Roll Paper Jam Problems](#)

[Cut Sheet Paper Jam Problems in the Paper Cassette](#)

[Cut Sheet Paper Jam Problems in the Front or Rear Manual Feeder](#)

Parent topic: [Solving Problems](#)

Paper Feeding Problems

If you have problems feeding paper, try these solutions:

- Make sure paper is loaded in the correct orientation. Load cut sheets vertically (short edge first).
- For best results, follow these guidelines:
 - Use new, smooth, high-quality paper that is not damp, curled, creased, old, too thin, or too thick.
 - Follow any special loading instructions that came with the paper.
- If roll paper does not feed, cut the end straight across and uncurl it by rolling it backward, if necessary. Then reload the paper.
- If you cannot insert paper easily into the paper feed slot, make sure the paper is perfectly flat and not curled.
- Do not load more than one piece of cut sheet paper.
- Make sure your paper meets the specifications for your product.
- If thick media does not feed, make sure you are loading it straight into the product, not at an angle.
- If paper does not eject correctly, decrease the **Paper Suction** setting for the loaded paper type.
- Make sure that paper is not jammed inside the product.

Parent topic: [Solving Paper Problems](#)

Related references

[Paper Menu Settings](#)

[Paper Specifications](#)

Related topics

[Roll Paper Handling](#)

[Cut Sheet Handling](#)

Roll Paper Jam Problems

If roll paper has jammed in the printer, follow the steps here to clear the jam.

1. Open the roll paper cover.
2. Cut the paper above the paper feed slot.

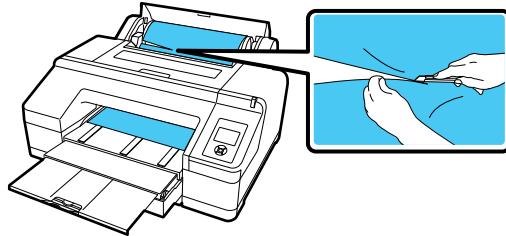

3. Lift the spindle from the spindle holder.

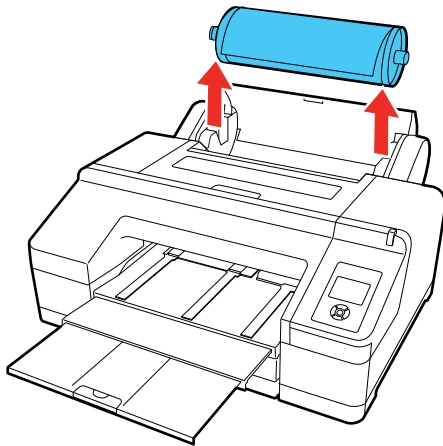

4. Remove the jammed paper from the roll paper feeder and/or the front manual feeder.

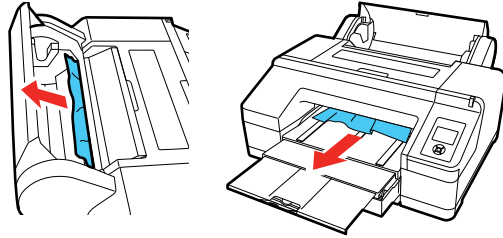

5. Open the printer cover and remove any other jammed paper as necessary.



6. Close the front cover.
7. Turn the printer off and back on again.
8. Cut the edge of the roll paper straight horizontally, then reload the roll paper.

Note: Make sure to cut off any jagged or folded sections of paper.

Parent topic: [Solving Paper Problems](#)

Related tasks

[Loading Roll Paper](#)

[Cutting Roll Paper Manually](#)

Cut Sheet Paper Jam Problems in the Paper Cassette

If cut sheet paper has jammed in the paper cassette, follow the steps here to clear the jam.

1. Remove the output tray and paper cassette.

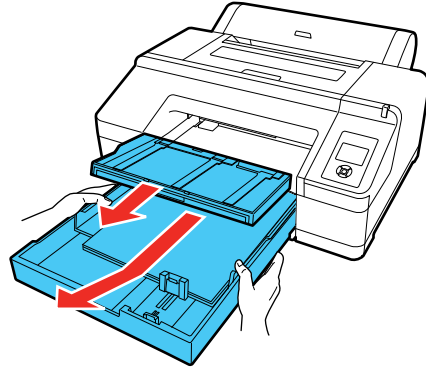

2. Remove any jammed paper from the front of the printer.

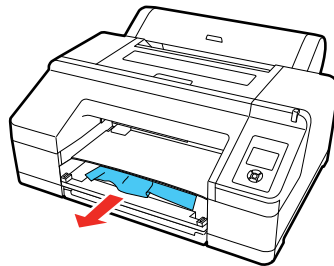

3. If paper is jammed in the rear of the printer, remove the rear unit. Push the tabs toward each other, then pull out the unit. Remove any jammed paper.

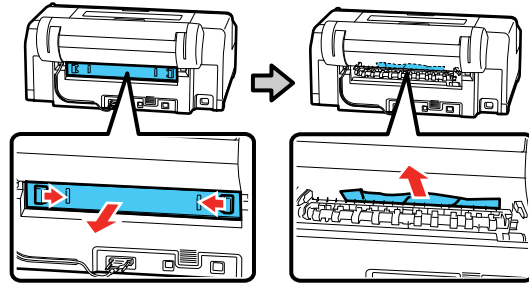

4. Replace the rear unit. Push it into the printer firmly until you hear a click.
5. Replace the paper cassette and the output tray.
6. Turn the printer off and back on again.

Parent topic: [Solving Paper Problems](#)

Related tasks

[Loading Cut Sheets in the Paper Cassette](#)

Cut Sheet Paper Jam Problems in the Front or Rear Manual Feeder

If cut sheet paper has jammed in the front or rear manual feeder, follow the steps here to clear the jam.

1. Remove the jammed paper.

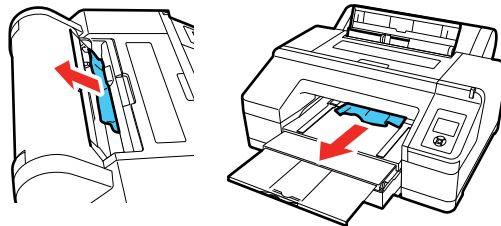

2. Open the printer cover. Remove any other jammed paper as necessary.

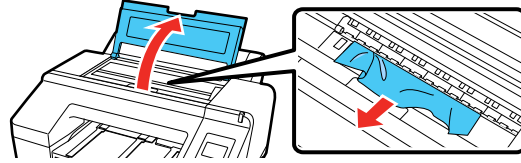

3. Close the printer cover.
4. Turn the printer off and back on again.

Parent topic: [Solving Paper Problems](#)

Related tasks

- [Loading Cut Sheets in the Rear Manual Feeder](#)
- [Loading Cut Sheets in the Front Manual Feeder](#)

Solving Print Quality Problems

Check these sections if you have problems with print quality.

- [Nozzle Check Pattern Prints Incorrectly](#)
- [Overall Print Quality is Poor](#)
- [Lines Are Misaligned](#)
- [Prints are Scuffed or Smearred](#)
- [Margins Appear in Borderless Roll Prints](#)
- [Too Much Ink is Consumed](#)

Parent topic: [Solving Problems](#)

Nozzle Check Pattern Prints Incorrectly

If the nozzle check pattern does not print correctly, try these solutions:

- Run a **Normal** cleaning cycle and print the check pattern again. If cleaning the print head three times does not solve the problem, run a **Heavy** cleaning cycle.
- If nozzles are still clogged after head cleaning at the strongest level, leave the product turned off overnight and check the nozzles again. If you still cannot clear the nozzles, contact Epson support.
- If the printer has not been used for a long time, nozzles may be dried and clogged. Turn the printer on at least once every few weeks and print a nozzle check pattern to prevent the nozzles from clogging.

Parent topic: [Solving Print Quality Problems](#)

Related concepts

[Print Head Nozzle Check](#)

[Print Head Cleaning](#)

Related references

[Administrator Menu Settings](#)

Related tasks

[Using the Powerful Cleaning Utility](#)

Overall Print Quality is Poor

If you notice that your print quality is uneven, too light, too dark, or there are lines in the print (banding), try these solutions:

- Run a nozzle check to see if any of the print head nozzles are clogged. Then clean the print head, if necessary.
- Align the print head.
- Make sure you are using genuine Epson ink cartridges. If you use non-Epson ink cartridges, the print result may be faint or the color of the printed image may be inaccurate because the remaining ink level is not correctly detected.
- Make sure your ink cartridges have not expired. For best results, use ink cartridges before the expiration date printed on the package (within six months of installation in the printer). Replace expired cartridges with new ones.
- Shake the cartridges before installing them in the printer. To maintain optimum print quality, remove and shake the installed cartridges if the printer has not been used in the last three months.
- Make sure you selected the correct **Media Type** setting in the printer driver that matches the paper loaded in the printer.
- Compare the print result with the image on your computer screen. Since monitors and printers produce colors differently, printed colors and screen colors do not always look the same.
- Make sure that the printer cover is closed during printing.
- Check the ink levels on the LCD screen. Replace any cartridges that are low on ink.
- Enable color management in the software application or in the printer driver.
- If you are using non-Epson media, make sure you create a custom paper configuration for the media.

- Check the quality setting that you selected in the printer driver. Using a faster printing method may decrease the overall print quality.

Parent topic: [Solving Print Quality Problems](#)

Related concepts

[Print Head Nozzle Check](#)

[Print Head Cleaning](#)

[Print Head Alignment](#)

[Purchase Epson Ink Cartridges and Maintenance Tanks](#)

Related references

[Print Quality Options - Windows](#)

[Color Management Options - Windows](#)

[Output Resolution Settings - Mac](#)

[Advanced Color Settings - Mac](#)

Related tasks

[Removing and Installing Ink Cartridges](#)

[Creating Custom Paper Configurations](#)

[Selecting Basic Print Settings - Windows](#)

[Selecting Basic Print Settings - Mac](#)

Lines Are Misaligned

You may see vertical lines in the (bi-directional) print output. If this occurs, align the print head.

Parent topic: [Solving Print Quality Problems](#)

Related concepts

[Print Head Alignment](#)

Prints are Scuffed or Smeared

If your prints are scuffed or smeared, try these solutions:

- Make sure your paper meets the specifications for your product.
- Do not use paper with folds or creases and always use new media.
- If you are using cut sheet paper, check that changes in humidity and temperature have not made the paper wavy or curled up on the edges. Flatten the paper before loading it or use new paper.
- If the surface of the paper is scuffed, select a wider **Platen Gap** setting.

- If the bottom edge is scuffed, try widening the bottom margin.
- If ink is smeared on your prints, clean the rollers. Load blank paper and press the ↵ paper feed button to feed it through the printer.
- If you are using non-Epson media, make sure you create a custom paper configuration for the media.
- Make sure the **Paper Size Check** setting is set to **On**, or the printer may print outside the edges of the loaded paper and smear ink on the back of the print.
- Depending on the print density and type of paper you are using, the ink may take a while to dry. Do not stack the prints until the ink is completely dry.

Parent topic: [Solving Print Quality Problems](#)

Related references

[Paper Menu Settings](#)

[Printer Setup Menu Settings](#)

Related tasks

[Creating Custom Paper Configurations](#)

Margins Appear in Borderless Roll Prints

If borderless roll prints still have margins, try these solutions:

- Check the print settings selected in your print application you are using, as well as the printer driver.
- Make sure that the paper settings on the LCD screen match the paper you loaded.
- Make sure borderless enlargement is not set to **Min** in the printer driver.
- Paper that is stored incorrectly may expand or contract. Make sure you have stored the paper according to the manufacturer's specifications.
- Check that the paper you are using supports borderless printing.
- Change the **Adjust Cut Position** setting. This may reduce the margins at the top and bottom of the print.

Parent topic: [Solving Print Quality Problems](#)

Related references

[Maintenance Menu Settings](#)

[Paper Menu Settings](#)

[Borderless Paper Type Compatibility](#)

[Roll Paper Options - Windows](#)

Related tasks

[Selecting Roll Paper Settings - Mac](#)

Too Much Ink is Consumed

If your printer is consuming too much ink during printing, try these solutions:

- Make sure you selected the **Media Type** setting in the printer driver that matches the paper you loaded in the printer. The amount of ink used during printing is controlled by the **Media Type** setting.
- Lower the density of ink in the paper or media options in the printer driver.

Parent topic: [Solving Print Quality Problems](#)

Related references

[Paper Configuration Options - Windows](#)

Related tasks

[Selecting Basic Print Settings - Windows](#)

[Selecting Basic Print Settings - Mac](#)

[Selecting Advanced Media Control Settings - Mac](#)

Where to Get Help

Epson provides technical support and information on the installation, configuration, and operation of professional printing products through the Epson Preferred Limited Warranty Plan. Dial (888) 377-6611, 6 AM to 6 PM, Pacific Time, Monday through Friday. Days and hours of support are subject to change without notice.

Note: If you experience difficulty with the toll-free number, call (562) 276-1305 (U.S.) or (905) 709-3481 (Canada).

Before you call, make sure you have your printer serial number and proof of purchase.

Visit epson.com/support (U.S.) or epson.ca/support (Canada) and select your product for solutions to common problems. You can download drivers, firmware, and documentation, get FAQs and troubleshooting advice, or e-mail Epson with your questions.

Note: For help using any other software on your system, see the documentation for that software for technical support information.

Purchase Supplies and Accessories

You can purchase genuine Epson ink, paper, and accessories from an Epson authorized reseller. To find the nearest reseller, visit proimaging.epson.com (U.S.) or proimaging.epson.ca (Canada), select your product series and product, and click the **Where to Buy** button. Or call 800-GO-EPSON (800-463-7766) in the U.S. or 800-807-7766 in Canada.

Parent topic: [Solving Problems](#)

Technical Specifications

These sections list the technical specifications for your product.

Note: Epson offers a recycling program for end of life Epson products. Please go to [this site](#) (U.S) or [this site](#) (Canada) for information on how to return your Epson products for proper disposal.

[Windows System Requirements](#)

[Mac System Requirements](#)

[Paper Specifications](#)

[Printable Area Specifications](#)

[Ink Cartridge Specifications](#)

[Dimension Specifications](#)

[Electrical Specifications](#)

[Environmental Specifications](#)

[Interface Specifications](#)

[Safety and Approvals Specifications](#)

Windows System Requirements

To use your product and its software, your computer should meet these requirements.

Microsoft Windows OS version (32- and 64-bit compatible)	Windows 10, Windows 8.x, Windows 7
CPU	Core 2 Duo 3.05 GHz or better
Memory	1GB or more
Hard disk space available	32GB or more
Interface	High-Speed USB port compatible with USB 2.0 Specification
	Ethernet 10BASE-T/100BASE-TX/1000BASE-T
Display resolution	SVGA (800 × 600) or higher

Note: For the latest product software available for your operating system, visit the Epson support site at epson.com/support (U.S.), epson.ca/support (Canada), or epson.com.jm/support (Caribbean), select your product, and select **Downloads**.

Parent topic: [Technical Specifications](#)

Mac System Requirements

To use your product and its software, your Mac should meet these requirements.

OS X version	Mac OS X 10.7 through macOS 10.12.x
CPU	Core 2 Duo 3.05 GHz or better
Memory	1GB or more
Hard disk space available	32GB or more
Interface	High-Speed USB port compatible with USB 2.0 Specification
	Ethernet 10BASE-T/100BASE-TX/1000BASE-T
Display resolution	WXGA (1280 × 800) or higher

Note: For the latest product software available for your operating system, visit the Epson support site at epson.com/support (U.S.), epson.ca/support (Canada), or epson.com.jm/support (Caribbean), select your product, and select **Downloads**.

Parent topic: [Technical Specifications](#)

Paper Specifications

Note: Since the quality of any particular brand or type of paper may be changed by the manufacturer at any time, Epson cannot guarantee the quality of any non-Epson brand or type of paper. Always test a sample of paper stock before purchasing large quantities or printing large jobs.

Cut sheet paper

Size

A4 (8.3 × 11.7 inches [210 × 297 mm])
A3 (11.7 × 16.5 inches [297 × 420 mm])
13 × 19 inches (330 × 483 mm)
A2 (16.5 × 23.4 inches [420 × 594 mm])
Letter (8.5 × 11 inches [216 × 279 mm])
Legal (8.5 × 14 inches [216 × 356 mm])
8 × 10 inches (203 × 254 mm)
9 × 12 inches (229 × 305 mm)
10 × 12 inches (254 × 305 mm)
11 × 14 inches (279 × 356 mm)
11 × 17 inches (279 × 432 mm)
12 × 12 inches (305 × 305 mm)
12 × 18 inches (305 × 457 mm)
16 × 20 inches (279 × 432 mm)
17 × 22 inches (432 × 559 mm)

Thickness

0.003 to 0.06 inch (0.08 to 1.5 mm)
Thick paper: 0.03 to 0.06 inch (0.8 to 1.5 mm)

Roll paper

Core size

2 inches (51 mm) and 3 inches (76 mm)

Outer diameter

2-inch core: up to 4 inches (103 mm)
3-inch core: up to 6 inches (150 mm)

Width

8 inches (203 mm) to 17 inches (432 mm)

Length

2-inch core: up to 147 feet (45 m)
3-inch core: up to 100 feet (30.5 m)

Thickness 0.003 to 0.02 inch (0.08 to 0.5 mm)

Note: Maximum thickness is reduced to 0.02 inch (0.45 mm) when using the optional SpectroProofer.

Parent topic: [Technical Specifications](#)

Printable Area Specifications

Note: When printing borderless, quality may decline in the expanded printable area.

Cut sheet paper

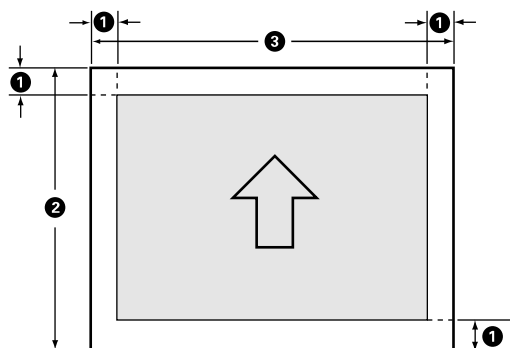

- 1 Left/right/top/bottom margin: 0.12 inch (3 mm) minimum
- 2 Printable length: 10 inches (254 mm) to 24 inches (610 mm)
- 3 Printable width: 8 inches (203 mm) to 17 inches (432 mm)

Roll paper

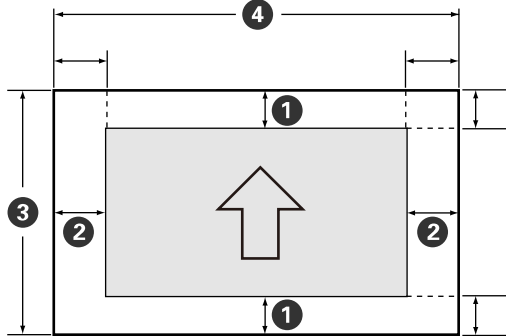

Note: Margins may change depending on the Roll Paper Margin setting that you select. The numbers below are the default settings. When printing with the left and right borderless setting, the left and right margins are 0. When printing with the borderless on all sides setting, all margins are 0.

- 1 Top/bottom margin: 0.59 inch (15 mm) minimum*
- 2 Left/right margin: 0.12 inch (3 mm) minimum
- 3 Printable length: 0.4 feet (0.13 m) to 49.2 feet (15 m)**
- 4 Printable width: 8 inches (203 mm) to 17 inches (432 mm)

* For these paper types the default top and bottom margins are 0.8 inch (20 mm): Epson Premium Glossy Photo Paper (250), Epson Premium Semigloss Photo Paper (250), Epson Premium Luster Photo Paper (260), and Epson Premium Semimatte Photo Paper (250).

** The maximum printable length using the Epson driver is 49.2 feet (15 m). To print longer images, you need to use third-party banner printing software.

Parent topic: [Technical Specifications](#)

Ink Cartridge Specifications

Note: This product uses only genuine Epson-brand cartridges. Other brands of ink cartridges and ink supplies are not compatible and, even if described as compatible, may not function properly.

The cartridges included with the printer are designed for printer setup and not for resale. After some ink is used for charging, the rest is available for printing. Yields vary considerably based on images printed,

print settings, paper type, frequency of use, and temperature. For print quality, a variable amount of ink remains in the cartridge after the "replace cartridge" indicator comes on.

Pigment ink

Standard Edition: Cyan, Light Cyan, Vivid Magenta, Vivid Light Magenta, Yellow, Orange, Green, Light Light Black, Light Black, Photo Black, Matte Black.

Commercial Edition: Cyan, Light Cyan, Vivid Magenta, Vivid Light Magenta, Yellow, Orange, Green, Violet, Light Black, Photo Black, Matte Black.

Note: The ink configuration is permanent (Light Light Black or Violet) once the printer completes its initial ink charge and can not be changed.

Cartridge life

Unopened package: do not use if the date on the package has expired

Print quality guarantee

After installation: 6 months

Temperature

In transit (unopened): -4 to 140 °F (-20 to 60 °C)

Storage: -4 to 104 °F (-20 to 40 °C)

1 month at 104 °F (40 °C)

Ink freezes at 14 °F (-10 °C)

Ink thaws and is usable after 4 hours at 77 °F (25 °C)

Parent topic: [Technical Specifications](#)

Related references

[Ink Cartridge and Maintenance Tank Part Numbers](#)

Dimension Specifications

Height	16 inches (405 mm)
Width	34 inches (863 mm)
Depth	30 inches (766 mm)

Weight 114.6 lb (52 kg)
(without ink cartridges or optional equipment)

Parent topic: [Technical Specifications](#)

Electrical Specifications

Power supply rating 100 to 240 V
Rated frequency range 50/60 Hz
Input frequency range 49.5/60.5 Hz
Rated current 0.7 to 0.4 A
Power consumption Printing: 52 W (55 W with optional SpectroProofer installed)
(ISO/IEC24712)
Sleep mode: 5.0 W
Power off mode: 0.5 W or less

Parent topic: [Technical Specifications](#)

Environmental Specifications

Temperature Operating: 50 to 95 °F (10 to 35 °C)
Operating (recommended): 65 to 75 °F (18 to 24 °C)
Storage (before unpacking): -4 to 140 °F (-20 to 60 °C)
1 month at 104 °F (40 °C)
Storage (after unpacking): -4 to 104 °F (-20 to 40 °C)
1 month at 104 °F (40 °C)
Humidity Operating: 20 to 80% RH
(non-condensing) Operating (recommended): 45 to 60% RH
Storage: 5 to 85% RH

Parent topic: [Technical Specifications](#)

Interface Specifications

USB Interface

Hi-Speed USB-Compatible with the Universal Serial Bus Specifications Revision 2.0

Network Interface

10BASE-T/100BASE-TX /1000BASE-T (use a Category5/5e or higher shielded twisted pair cable)

Parent topic: [Technical Specifications](#)

Safety and Approvals Specifications

United States

Safety: UL60950-1

EMC: FCC part 15 Subpart B class B

Canada

Safety: CAN/CSA C22.2 No. 60950-1

EMC: CAN/CSA-CEI/IEC CISPR 22 Class B

Parent topic: [Technical Specifications](#)

Notices

Check these sections for important notices about your product.

Note: Epson offers a recycling program for end of life Epson products. Please go to [this site](#) (U.S) or [this site](#) (Canada) for information on how to return your Epson products for proper disposal.

[Important Safety Instructions](#)

[FCC Compliance Statement](#)

[Trademarks](#)

[Copyright Notice](#)

Important Safety Instructions

Before using your Epson product, read and follow these safety instructions.

[General Product Safety Instructions](#)

[Ink Cartridge Safety Instructions](#)

Parent topic: [Notices](#)

General Product Safety Instructions

- Be sure to follow all warnings and instructions marked on the product.
- Do not attempt to service this product yourself.
- Use only the type of power source indicated on the product's label.
- Use only the power cord that comes with the product. Use of another cord may cause fires or shock. Do not use the cord with any other equipment.
- Place the product near a wall outlet where the plug can be easily unplugged.
- Connect your product to a properly grounded power outlet. Avoid plugging the product into an outlet on the same circuit as a photo copier or air control system that regularly switches on and off, or on an outlet controlled by a wall switch or timer.
- Do not let the power cord become damaged or frayed. Place it to avoid abrasions, cuts, fraying, crimping, and kinking. Do not place objects on top of it and do not allow it to be stepped on or run over. Be careful to keep the cord straight at each end.
- If you use an extension cord with the product, make sure the total ampere rating of the devices plugged into the extension cord does not exceed the cord's ampere rating. Also, make sure the total

ampere rating of all devices plugged into the wall outlet does not exceed the wall outlet's ampere rating.

- If damage occurs to the plug, replace the cord set or consult a qualified electrician. If there are fuses in the plug, make sure you replace them with fuses of the correct size and rating.
- Always turn off the product using the power button, and wait until the power light stops flashing before unplugging the product or cutting off power to the electrical outlet.
- If you will not be using the product for a long period, unplug the power cord from the electrical outlet.
- Place the product on a flat, stable surface that extends beyond its base in all directions. It will not operate properly if it is tilted or at an angle.
- Avoid locations that are subject to rapid changes in heat or humidity, shocks or vibrations, or dust.
- Do not place or store the product outdoors.
- Do not place the product near excessive heat sources or in direct sunlight.
- Leave enough room around the product for sufficient ventilation. Do not block or cover openings in the cabinet or insert objects through the slots.
- Keep the product away from potential sources of electromagnetic interference, such as loudspeakers or the base units of cordless telephones.
- When connecting the product to a computer or other device with a cable, ensure the correct orientation of the connectors. Each connector has only one correct orientation. Inserting a connector in the wrong orientation may damage both devices connected by the cable.
- Do not put your hands inside the product or touch the ink cartridges while printing.
- Do not move the print head by hand; this may damage the product.
- Do not spill liquid on the product or use the product with wet hands.
- Do not use aerosol products that contain flammable gases inside or around the product. Doing so may cause fire.
- Except as specifically explained in your documentation, do not attempt to service the product yourself.
- Unplug the product and refer servicing to qualified service personnel under the following conditions: if the power cord or plug is damaged; if liquid has entered the product; if the product has been dropped or the cabinet damaged; if the product does not operate normally or exhibits a distinct change in performance. Adjust only those controls that are covered by the operating instructions.
- When storing or transporting the product, do not tilt it, stand it on its side, or turn it upside down; otherwise ink may leak.

Note: The lithium batteries in this product contain Perchlorate Material - special handling may apply. [Click here](#) for details.

Parent topic: [Important Safety Instructions](#)

Ink Cartridge Safety Instructions

- Keep ink cartridges out of the reach of children and do not drink the ink.
- Be careful when you handle used ink cartridges; there may be ink remaining around the ink supply port. If ink gets on your skin, wash it off with soap and water. If it gets in your eyes, flush them immediately with water.
- Do not put your hand inside the product or touch any cartridges during printing.
- Install a new ink cartridge immediately after removing an expended one. Leaving cartridges uninstalled can dry out the print head and may prevent the product from printing.
- Install ink cartridges in all the ink cartridge slots. You cannot print if any of the slots are empty.
- Dried ink on the supply port may cause ink leaks when the cartridge is reinserted and used. Wipe off any excess ink before reinserting.
- Do not insert or remove replacement cartridges during printing.
- Do not remove the transparent seal from the ink supply port. This may cause the cartridge to become unusable.
- The green IC chip on this ink cartridge retains a variety of cartridge-related information, such as the ink cartridge status, so that the cartridge may be removed and reinserted freely. Do not touch the green IC chip on the side of the cartridge. This may prevent normal operation and printing.
- If you remove an ink cartridge for later use, protect the ink supply area from dirt and dust and store it in the same environment as the product. Note that there is a valve in the ink supply port, making covers or plugs unnecessary, but care is needed to prevent the ink from staining items that the cartridge touches. Do not touch the ink cartridge ink supply port or surrounding area.
- To ensure print quality, use an ink cartridge before the date printed on its package.
- Do not dismantle or alter an ink cartridge. This could damage the print head and may prevent the product from printing.
- Do not drop cartridges or bump them against hard objects; otherwise, the ink may leak.
- Store ink cartridges at room temperature in a location that is not exposed to direct sunlight.
- After bringing an ink cartridge inside from a cold storage site, allow it to warm up at room temperature for at least four hours before using it.

Parent topic: [Important Safety Instructions](#)

FCC Compliance Statement

For United States Users

This equipment has been tested and found to comply with the limits for a Class B digital device, pursuant to Part 15 of the FCC Rules. These limits are designed to provide reasonable protection against harmful interference in a residential installation. This equipment generates, uses, and can radiate radio frequency energy and, if not installed and used in accordance with the instructions, may cause harmful interference to radio or television reception. However, there is no guarantee that interference will not occur in a particular installation. If this equipment does cause interference to radio and television reception, which can be determined by turning the equipment off and on, the user is encouraged to try to correct the interference by one or more of the following measures:

- Reorient or relocate the receiving antenna.
- Increase the separation between the equipment and receiver.
- Connect the equipment into an outlet on a circuit different from that to which the receiver is connected.
- Consult the dealer or an experienced radio/TV technician for help.

WARNING

The connection of a non-shielded equipment interface cable to this equipment will invalidate the FCC Certification or Declaration of this device and may cause interference levels which exceed the limits established by the FCC for this equipment. It is the responsibility of the user to obtain and use a shielded equipment interface cable with this device. If this equipment has more than one interface connector, do not leave cables connected to unused interfaces. Changes or modifications not expressly approved by the manufacturer could void the user's authority to operate the equipment.

For Canadian Users

CAN ICES-3(B)/NMB-3(B)

Parent topic: [Notices](#)

Trademarks

EPSON®, SureColor®, PrecisionCore®, and SpectroProofer® are registered trademarks and EPSON Exceed Your Vision is a registered logomark of Seiko Epson Corporation.

Epson StoreSM is a service mark of Epson America, Inc.

Mac and OS X are trademarks of Apple Inc., registered in the U.S. and other countries.

General Notice: Other product names used herein are for identification purposes only and may be trademarks of their respective owners. Epson disclaims any and all rights in those marks.



Parent topic: [Notices](#)

Copyright Notice

All rights reserved. No part of this publication may be reproduced, stored in a retrieval system, or transmitted in any form or by any means, electronic, mechanical, photocopying, recording, or otherwise, without the prior written permission of Seiko Epson Corporation. The information contained herein is designed only for use with this Epson product. Epson is not responsible for any use of this information as applied to other products.

Neither Seiko Epson Corporation nor its affiliates shall be liable to the purchaser of this product or third parties for damages, losses, costs, or expenses incurred by purchaser or third parties as a result of: accident, misuse, or abuse of this product or unauthorized modifications, repairs, or alterations to this product, or (excluding the U.S.) failure to strictly comply with Seiko Epson Corporation's operating and maintenance instructions.

Seiko Epson Corporation shall not be liable for any damages or problems arising from the use of any options or any consumable products other than those designated as Original Epson Products or Epson Approved Products by Seiko Epson Corporation.

Seiko Epson Corporation shall not be held liable for any damage resulting from electromagnetic interference that occurs from the use of any interface cables other than those designated as Epson approved Products by Seiko Epson Corporation.

This information is subject to change without notice.

[A Note Concerning Responsible Use of Copyrighted Materials](#)
[Copyright Attribution](#)

Parent topic: [Notices](#)

A Note Concerning Responsible Use of Copyrighted Materials

Epson encourages each user to be responsible and respectful of the copyright laws when using any Epson product. While some countries' laws permit limited copying or reuse of copyrighted material in

certain circumstances, those circumstances may not be as broad as some people assume. Contact your legal advisor for any questions regarding copyright law.

Parent topic: [Copyright Notice](#)

Copyright Attribution

© 2017 Epson America, Inc.

5/17

CPD-52925R1

Parent topic: [Copyright Notice](#)