

EPSON®

**AM-C4000/AM-C5000/AM-C6000
User's Guide**

Contents

AM-C4000/AM-C5000/AM-C6000 User's Guide	19
Product Basics	20
Product Parts Locations	20
Product Parts - Front and Inside	21
Product Parts - Back.....	24
Product Parts - Options	26
Optional Accessories and Replacement Parts	29
Using the Control Panel	31
Control Panel Buttons and Lights	32
Status Icon Information	32
Guide to the Home Screen	34
Entering Characters on the LCD Screen	36
Selecting the Date and Time	36
Selecting Your Country or Region	37
Changing LCD Screen Language.....	38
Adjusting Control Panel Sounds.....	38
Turning Off the Operation Time Out Setting	39
Adjusting the Screen Brightness.....	39
Checking the Print Counter.....	39
Using Presets	40
Checking for Software Updates.....	40
Using Power Saving Settings	41
Changing the Sleep Timer Settings.....	41
Changing the Power Off Timer Settings	42
Epson Connect Solutions for Smartphones, Tablets, and More	42
Setting Up Epson Connect Services.....	43
Using Epson Email Print	43
Using Epson Remote Print	44
Using Epson Scan to Cloud.....	44
Using the Epson Smart Panel Mobile App.....	45

Using AirPrint	46
Android Printing Using the Epson Print Enabler	47
Using the Mopria Print Service	47
Wi-Fi or Wired Networking.....	49
Network Security Recommendations	49
Wi-Fi Infrastructure Mode Setup.....	50
Selecting Wireless Network Settings from the Control Panel	51
Wi-Fi Direct Mode Setup	52
Enabling Wi-Fi Direct Mode	53
Modifying the Wi-Fi Direct Network Name or Password	54
Wi-Fi Protected Setup (WPS).....	55
Using WPS to Connect to a Network	55
Printing a Network Status Sheet.....	56
Printing a Network Connection Report	56
Network Connection Report Codes and Messages	57
Enabling Epson Universal Print Driver (PCL) or PostScript Printing.....	64
Installing the Epson Universal Print Driver - Windows	64
Installing the PostScript (PS3) Printer Software - Windows	68
Installing the PostScript (PS3) Printer Software - Mac	68
Selecting PDL (Page Description Language) Settings	69
PDL Print Configuration Options.....	69
Selecting Printer Language and Interface Settings	72
Printing Language and Interface Options	72
Printing a PCL or PS3 (PostScript) Status Sheet	73
Loading Paper	74
Loading Paper in the Cassettes and Paper Tray	74
Paper Loading Orientation.....	76
Using the Optional Paper Cassette Lock.....	84
Paper Loading Capacity	87
Double-sided Printing	90
Compatible Epson Papers (U.S. and Canada).....	91
Compatible Epson Papers (Latin America)	92
Paper or Media Type Settings - Printing Software.....	93

Selecting the Paper Settings for Each Source - Control Panel	94
Paper Type Settings - Control Panel	94
Selecting Default Paper Settings - Administrator.....	95
Selecting the Default Printer Settings	95
Paper Source Settings Options.....	96
Selecting the Universal Print Settings.....	97
Universal Print Settings Options	97
Placing Originals on the Product	99
Placing Originals on the Scanner Glass	99
Placing Originals in the Automatic Document Feeder	100
Copying	101
Copying Documents or Photos.....	101
Copying Special Originals	102
Copying, Sorting, and Creating Booklets.....	104
Copying and Creating Booklets	104
Copying and Creating Finished Booklets.....	106
Creating Folded, Stapled, or Punched Copies.....	107
Stacking Copies Using Orientation	108
Stacking Copies Using Offset.....	108
Inserting Slipsheets	109
Copying Options.....	109
Saving Groups for Copying	116
Editing or Deleting a Saved Group for Copying	116
Omitting Red Characters in Originals When Copying.....	117
Printing from a Computer	118
Printing with the Standard Epson Printer Software - Windows	118
Synchronizing Printer Settings for Optional Units - Windows	119
Selecting Basic Print Settings - Windows	120
Paper Source Options - Windows	123
Multi-Page Printing Options - Windows.....	123
Selecting Double-sided Printing Settings - Windows	124
Double-sided Printing Options - Windows.....	126
Selecting Finishing Options - Windows	126

Finishing Options - Windows.....	128
Using the Manual Stapler.....	128
Selecting Additional Print Options - Windows.....	130
Custom Color Correction Options - Windows.....	132
Image Options and Additional Settings - Windows.....	133
Header/Footer Settings - Windows.....	134
Selecting a Printing Preset - Windows.....	135
Selecting Extended Settings - Windows.....	136
Extended Settings - Windows.....	137
Printing Your Document - Windows.....	138
Printing Slip Sheets and Chapter Papers.....	139
Saving Print Set Groups - Windows.....	143
Editing or Deleting a Saved Group.....	143
Locking Printer Settings - Windows.....	146
Locked Setting Options.....	148
Entering a User ID and Password for Printing.....	149
Selecting Default Print Settings - Windows.....	150
Changing the Language of the Printer Software Screens.....	151
Changing Automatic Update Options.....	152
Printing with the Epson Standard Printer Software - Mac.....	153
Selecting Basic Print Settings - Mac.....	154
Paper Source Options - Mac.....	156
Selecting Page Setup Settings - Mac.....	157
Selecting Print Layout Options - Mac.....	158
Selecting Double-sided Printing Settings - Mac.....	158
Double-sided Printing Options and Adjustments - Mac.....	159
Managing Color - Mac.....	160
Color Matching and Color Options - Mac.....	161
Selecting Finishing Options - Mac.....	161
Finishing Options - Mac.....	162
Selecting Printing Preferences - Mac.....	163
Printing Preferences - Mac.....	164
Printing Your Document - Mac.....	165

Checking Print Status - Mac.....	165
Printing with the Epson Universal Print Driver - Windows.....	166
Synchronizing Printer Settings - Epson Universal Print Driver - Windows	167
Selecting Print Settings - Epson Universal Print Driver - Windows	168
Selecting Default Print Settings - Epson Universal Print Driver - Windows	170
Locking Printer Settings - Epson Universal Print Driver - Windows	171
Epson Universal Print Driver Locked Setting Options	173
Adding Network Printers - Epson Universal Print Driver - Windows.....	173
Printing with the PostScript (PS3) Printer Software - Windows	176
Selecting Basic Print Settings - PostScript Printer Software - Windows	176
Selecting Default Print Settings - PostScript Printer Software - Windows.....	179
Printing with the PostScript (PS3) Printer Software - Mac	180
Selecting Basic Print Settings - PostScript Printer Software - Mac	181
Printing from a Smartphone or Tablet.....	184
Cancelling Printing Using the Product Control Panel	184
Scanning	185
Starting a Scan.....	185
Starting a Scan Using the Product Control Panel	185
Scanning to Email	186
Scanning to a Memory Device	187
Scanning to the Cloud.....	188
Scanning to the Product's Hard Drive	189
Scanning to a Connected Computer	190
Setting Up a WSD Port (Windows 7).....	191
Control Panel Scanning Options	192
Setting Up and Scanning to a Network Folder or FTP Server.....	194
Creating a Shared Network Folder.....	194
Registering Contacts for Network Folder or FTP Scanning - Web Config	196
Registering Contacts for Email, Network, or FTP Scanning - Control Panel	197
Scanning to a Network Folder or FTP Server.....	199
Starting a Scan Using the Epson Scan 2 Icon	200
Starting a Scan from a Scanning Program.....	201
Starting a Scan from a Smartphone or Tablet.....	203

Scanning with Document Capture Pro or Document Capture	204
Scanning with Simple Scan in Document Capture Pro - Windows	204
Scanning with Job Scan in Document Capture Pro - Windows.....	206
Adding and Assigning Scan Jobs with Document Capture Pro - Windows	207
Scanning with Document Capture - Mac	210
Scanning in Epson Scan 2	213
Additional Scanning Settings - Main Settings Tab	215
Additional Scanning Settings - Advanced Settings Tab	216
Saving Scanned Documents as a Searchable PDF Using Epson Scan 2	217
Image Format Options	218
Scan Resolution Guidelines	219
Scanning Special Projects.....	220
Scanning to a SharePoint Server or Cloud Service - Windows.....	220
Scanning Multi-Page Originals as Separate Files - Windows	222
Entering a User ID and Password for Scanning	224
Faxing.....	226
Connecting a Telephone or Answering Machine	226
Setting Up Fax Features	231
Setting Up Basic Fax Features	231
Using the Fax Setup Wizard	231
Selecting the Line Type.....	233
Setting the Number of Rings to Answer	233
Selecting Advanced Fax Settings	234
Basic Settings - Fax	234
Send Settings - Fax.....	237
Receive Settings - Fax	238
Report Settings - Fax	240
Security Settings - Fax	241
Setting Up the Fax Utility - Windows.....	242
Setting Up Contacts and Contact Groups.....	245
Creating a Contact.....	245
Editing or Deleting a Contact	246
Creating a Contact Group.....	246

Editing or Deleting a Contact Group	247
Sending Faxes	248
Sending Faxes from the Product Control Panel.....	248
Sending a Fax Using the Keypad, Contact List, or History.....	248
Fax Sending Options	250
Sending a Fax at a Specified Time	252
Sending a Fax on Demand (Polling Send/Box).....	253
Sending a Fax on Demand (Bulletin Board Box).....	254
Sending a Stored Fax	255
Dialing Fax Numbers from a Connected Telephone	255
Sending Faxes Using the Fax Utility - Windows	256
Sending Faxes Using the Fax Utility - Mac	259
Sending IP Faxes Using the Control Panel.....	262
IP Fax Destination Examples	263
Receiving Faxes.....	264
Fax Reception	264
Receiving Faxes Automatically	264
Receiving Faxes Manually.....	264
Forwarding Received Faxes.....	265
Viewing a Fax on the LCD Screen (Using the Fax Box).....	266
Receiving a Fax by Polling	268
Checking Fax Status	268
Printing Fax Reports.....	269
Fax Report Options	269
Using External USB Devices with Your Product.....	270
Connecting a USB Device	270
Viewing and Printing from the LCD Screen	270
Printing JPEG Photos.....	270
Print Setting Options - JPEG Mode.....	271
Printing TIFF and PDF Files	274
Print Setting Options - TIFF Mode.....	275
Print Setting Options - PDF Mode.....	277
Transferring Files on a USB Device	280

Setting Up USB Device Access	280
Using Your Product's Internal Storage	281
Storage Folder Types	281
Creating Shared Folders	282
Printing a Stored File	282
Saving Groups for Printing from Storage	284
Editing or Deleting a Saved Group	284
Saving Stored Files to an External USB Device	285
Emailing Stored Files	285
Saving Stored Files to a Network Folder	286
Saving Stored Files to Cloud Services	286
Storage Menu Options	287
Searching for Folders and Files.....	293
Deleting Folders and Files from Storage	293
Changing the Storage Period of Files.....	294
Restricting Shared Folder Access	294
Replacing Ink Cartridges, Maintenance Boxes, and Cassette Rollers.....	296
Ink Safety Precautions	296
Check Cartridge and Maintenance Box Status.....	298
Checking Ink Status on the LCD Screen.....	299
Checking Ink and Maintenance Box Status with Windows	299
Checking Cartridge and Maintenance Box Status - Mac	300
Replacing Ink Cartridges and Maintenance Boxes.....	300
Purchase Epson Ink Cartridges and Maintenance Box	301
Ink Cartridge and Maintenance Box Part Numbers.....	301
Removing and Installing Ink Cartridges	302
Replacing the Maintenance Box	302
Replacing the Paper Feed Rollers	303
Replacing the Optional Staple Cartridge	303
Adjusting Print Quality	305
Print Head Maintenance.....	305
Checking the Nozzles Using the Product Control Panel	305
Cleaning the Print Head Using the Product Control Panel.....	307

Automatically Cleaning the Print Head Using the Product Control Panel	307
Cleaning and Transporting Your Product	308
Cleaning Your Product	308
Cleaning the Scanner Glass	308
Cleaning the Automatic Document Feeder	310
Moving or Transporting Your Product	314
Solving Problems	315
Viewing the Help Screen	315
Product Status Messages	316
Job Status Error Codes	319
Running a Product Check	323
Resetting Control Panel Defaults	324
Solving Setup Problems	326
Product Does Not Turn On or Off	326
Noise After Ink Installation	326
Software Installation Problems	327
Solving Network Problems	327
Product Cannot Connect to a Wireless Router or Access Point	328
Network Software Cannot Find Product on a Network	329
Wireless Network Connection is Unstable on a Mac	329
USB Connection Problems	330
USB 3.0 Connection is Unstable When Using a USB 2.0 Cable	330
Wired Network Connection Becomes Unstable	330
Product Does Not Appear in Mac Printer Window	331
Cannot Print Over a Network	331
Cannot Scan Over a Network	333
Solving Network Security Problems	334
Cannot Create the Secure IPP Printing Port	334
Cannot Update a Certificate or Create a CSR	335
Cannot Import a Digital Certificate	335
Deleted a CA-signed Certificate	336
Digital Certificate Warning Messages	336
Solving Copying Problems	338

Product Cannot Copy	338
Product Makes Noise, But Nothing Copies.....	338
Product Makes Noise When It Sits for a While.....	339
Solving Copy Quality Problems	339
Copies Have Incorrect or Faint Colors	339
Position, Size, or Margins of Copies are Incorrect	340
Solving Paper Problems	340
Paper Feeding Problems	340
Originals Do Not Feed From the Automatic Document Feeder.....	341
Paper Jam Problems	342
Paper Ejection Problems	342
Solving Problems Printing from a Computer.....	343
Nothing Prints	343
Product Icon Does Not Appear in Windows Taskbar	345
Printing is Slow	346
Solving Page Layout and Content Problems	347
Inverted Image.....	347
Too Many Copies Print	348
Blank Pages Print	348
Incorrect Margins on Printout.....	348
Incorrect Characters Print.....	349
Incorrect Image Size or Position	349
Slanted Printout	350
Solving Print Quality Problems	350
White or Dark Lines in Printout	351
Blurry or Smearred Printout	352
Faint Printout or Printout Has Gaps	353
Grainy Printout.....	354
Incorrect Colors	355
Solving Scanning Problems	356
Scanning Software Does Not Operate Correctly	356
Cannot Start Epson Scan 2	356
Solving Scanned Image Quality Problems	357

Image Consists of a Few Dots Only.....	358
Line of Dots Appears in All Scanned Images.....	358
Straight Lines in an Image Appear Crooked.....	359
Scanned Image Quality Problems.....	359
Image Colors are Patchy at the Edges.....	361
Ripple Patterns Appear in an Image.....	361
Scanned Image Edges are Cropped.....	361
Solving Faxing Problems.....	361
Cannot Send or Receive Faxes.....	362
Cannot Receive Faxes with a Telephone Connected to Your Product.....	363
Fax Memory Full Error Appears.....	363
Fax Quality is Poor.....	363
Sent Fax is Received in an Incorrect Size.....	364
Received Fax is Not Printed.....	364
Solving USB Device Problems.....	364
Cannot View or Print from a USB Device.....	365
Cannot Save Files on a USB Device.....	365
Cannot Transfer Files To or From a USB Device.....	365
Uninstall Your Product Software.....	365
Uninstalling Product Software - Windows.....	366
Uninstalling Product Software - Mac.....	367
Where to Get Help (U.S. and Canada).....	367
Where to Get Help (Latin America).....	368
Administering Your Product.....	371
Accessing the Web Config Utility.....	371
Changing the Administrator Password in Web Config.....	371
Configuring Product Settings.....	372
Checking Status Information.....	373
Managing the Network Connection.....	373
Network Settings.....	374
Setting Control Panel Options.....	378
Locking Individual Settings.....	378
Using an Email Server.....	379

Configuring an Email Server	379
Email Server Settings	380
Checking the Email Server Connection	380
Sending Email Notifications	381
Using an LDAP Server.....	381
Configuring the LDAP Server and Selecting Search Settings	382
LDAP Server Settings	382
LDAP Search Settings	384
LDAP Connection Report Messages	384
Adjusting Power Saving Settings.....	385
Adjusting Control Panel Sounds	386
Erasing Hard Drive Data.....	386
Importing and Exporting Product Settings	387
Exporting Settings Using Web Config	387
Importing Settings Using Web Config	387
Updating Firmware Using Web Config	388
Synchronizing the Date and Time with a Time Server	388
Clearing the Internal Memory	389
Adjusting the Contact List View Options	389
Powering Off or Rebooting the Product Remotely	389
Restoring Default Product Settings.....	389
Adjusting the Control Panel Layout	390
Configuring Security Settings	390
Connecting an Authentication Device.....	391
Restricting Features Available for Users	391
User Feature Restriction	391
Configuring User Feature Restrictions	392
Disabling the External Interface.....	393
Setting Up Password Encryption	393
Restoring the Password Encryption Key.....	394
Working with Audit Logs	394
Setting a Password Policy	395
Restricting Application Access	395

Restricting PDL File Operations	395
Enabling Program Verification on Start Up	396
Restricting Domain Access.....	396
Using Your Product on a Secure Network	396
Configuring Protocols and Services in Web Config	397
Protocol Settings.....	397
Configuring SSL/TLS Communication.....	402
Configuring SSL/TLS Settings	402
Configuring a Server Certificate for the Product.....	402
Configuring IPsec/IP Filtering	403
About IPsec/IP Filtering	403
Configuring the Default IPsec/IP Filtering Policy	403
Configuring the Group IPsec/IP Filtering Policies	404
IPsec/IP Filtering Policy Settings	404
IPsec/IP Filtering Configuration Examples.....	410
Configuring an IPsec/IP Filtering Certificate	411
Connecting the Product to an IEEE 802.1X Network.....	411
Configuring an IEEE 802.1X Network	411
IEEE 802.1X Network Settings	412
Configuring a Certificate for an IEEE 802.1X Network	413
IEEE 802.1X Network Status	413
Configuring S/MIME Settings	414
Configuring S/MIME Basic Settings	414
S/MIME Settings	415
Configuring a Certificate for S/MIME.....	416
Using a Digital Certificate	417
About Digital Certification.....	417
Obtaining and Importing a CA-signed Certificate	418
CSR Setup Settings	419
CSR Import Settings	419
Deleting a CA-signed Certificate	421
Updating a Self-signed Certificate.....	421
Importing a CA Certificate	422

Deleting a CA Certificate	422
Setting Up Universal Print (Microsoft)	423
Using Epson Device Admin Configuration Software.....	423
Technical Specifications	424
Windows System Requirements	425
Mac System Requirements	425
Paper Specifications	426
Printable Area Specifications	427
Scanning Specifications	428
Automatic Document Feeder (ADF) Specifications	429
Fax Specifications	430
Ink Cartridge Specifications.....	431
Dimension Specifications	431
Electrical Specifications	432
Environmental Specifications	433
Interface Specifications	433
External USB Device Specifications.....	433
Storage Specifications	434
Network Interface Specifications (U.S. and Canada)	435
Network Interface Specifications (Latin America).....	437
Safety and Approvals Specifications (U.S. and Canada)	439
Safety and Approvals Specifications (Latin America).....	439
Staple Finisher Specifications	440
Inner Finisher Specifications	447
Super G3/G3 Multi Fax Board Specifications	452
10/100/1000 Base-T Ethernet Specifications	452
Inner Tray Specifications.....	452
High-Capacity Unit Specifications	452
Optional Dual Cassette Specifications	453
HDD Specifications	453
Notices	454
Important Safety Instructions.....	454
General Product Safety Instructions	454

Ink Cartridge Safety Instructions.....	456
Wireless Connection Safety Instructions	457
LCD Screen Safety Instructions.....	457
Telephone Equipment Safety Instructions	458
FCC Compliance Statement.....	458
Binding Arbitration and Class Waiver	459
Trademarks	462
Copyright Notice.....	462
libTIFF Software Acknowledgment.....	463
A Note Concerning Responsible Use of Copyrighted Materials.....	464
Default Delay Times for Power Management for Epson Products	464
Copyright Attribution	464

AM-C4000/AM-C5000/AM-C6000 User's Guide

Welcome to the AM-C4000/AM-C5000/AM-C6000 *User's Guide*.

For a printable PDF copy of this guide, [click here](#).

Product Basics

See these sections to learn about the basic features of your product.

Note: This product contains an encrypted hard drive that is used for storing large and/or authenticated print, copy, and scan jobs. You may erase data stored on the encrypted hard drive by following the steps outlined in the link below. It is recommended that data is erased before disposing or giving away the product.

Note: Printing software instructions in this manual are intended for use with the standard Epson printer software. For more information on using the Printer Command Language (PCL) or PostScript (PS3) printer software, please see the appropriate sections.

[Product Parts Locations](#)

[Using the Control Panel](#)

[Checking for Software Updates](#)

[Using Power Saving Settings](#)

[Epson Connect Solutions for Smartphones, Tablets, and More](#)

[Using the Epson Smart Panel Mobile App](#)

[Using AirPrint](#)

[Android Printing Using the Epson Print Enabler](#)

[Using the Mopria Print Service](#)

Related tasks

[Clearing the Internal Memory](#)

Related topics

[Enabling Epson Universal Print Driver \(PCL\) or PostScript Printing](#)

Product Parts Locations

See these sections to identify the parts on your product.

[Product Parts - Front and Inside](#)

[Product Parts - Back](#)

[Product Parts - Options](#)

[Optional Accessories and Replacement Parts](#)

Parent topic: [Product Basics](#)

Product Parts - Front and Inside

Certain parts are labeled with a letter and number code. If you encounter any paper jams or errors, you can use these codes to locate and correct the problem.

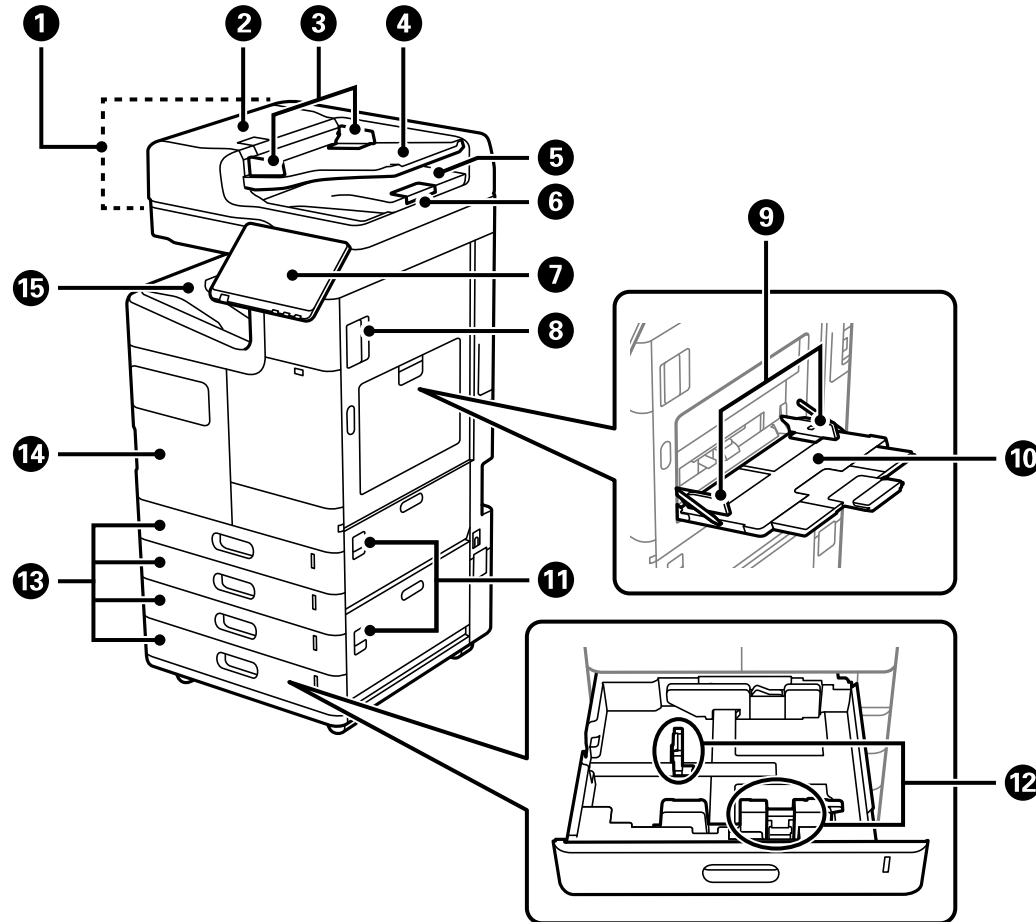

- 1 Automatic Document Feeder (ADF)
- 2 ADF cover (F)
- 3 ADF edge guides

- 4 ADF input tray
- 5 ADF output tray
- 6 ADF paper stopper
- 7 Control panel
- 8 Cover (D1)
- 9 Edge guide
- 10 Paper tray (B)
- 11 Cover (E, H)
- 12 Edge guide
- 13 Paper cassette 1, 2, 3, 4 (C1, C2, C3, C4)
- 14 Front cover (A)

15 Face down tray (G)

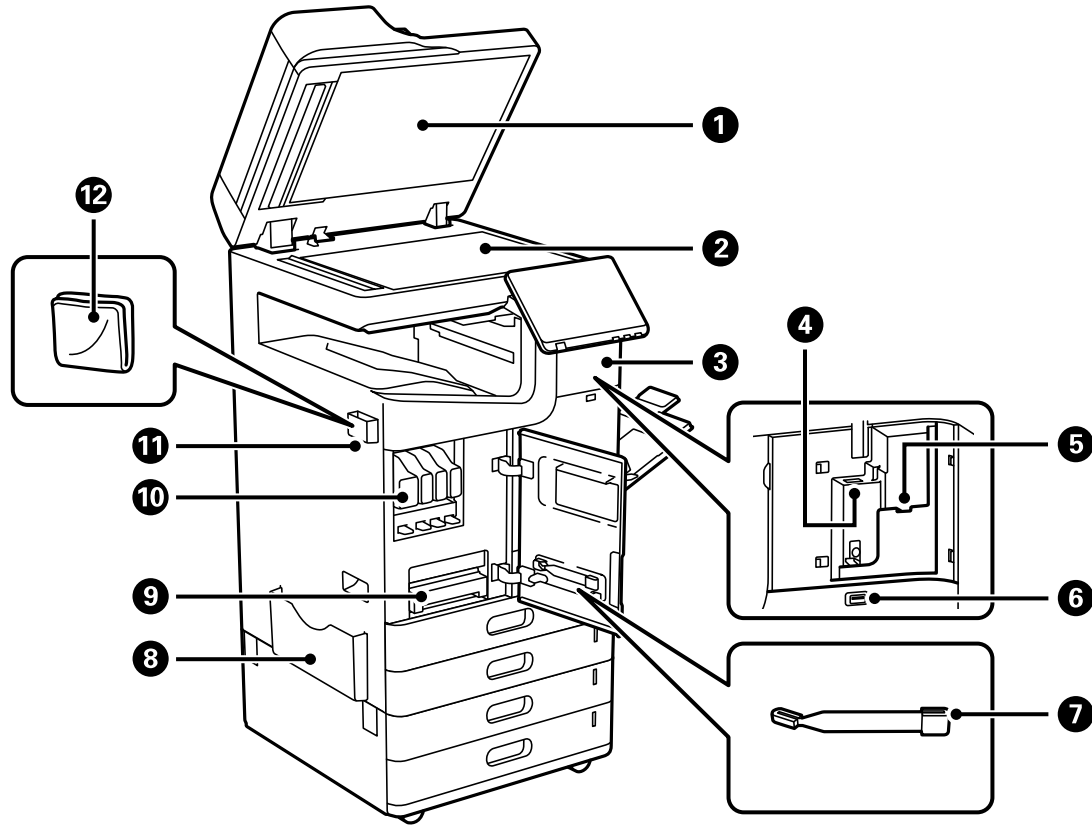

- 1 Document cover
- 2 Scanner glass
- 3 Cover
- 4 Optional Wireless LAN interface USB port
- 5 Service USB port
- 6 External interface USB port
- 7 Cleaning stick

- 8 Document holder
- 9 Maintenance box
- 10 Ink cartridge
- 11 Cleaning cloth holder (recommended location)
- 12 Cleaning cloth

Parent topic: [Product Parts Locations](#)

Product Parts - Back

Certain parts are labeled with a letter and number code.

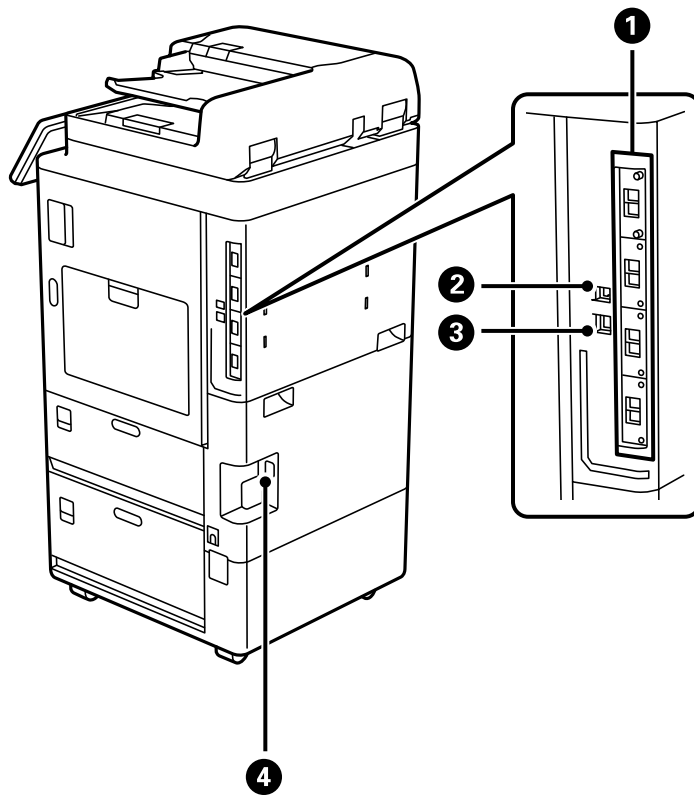

- 1 Additional interface slot

- 2 **USB** port
- 3 **LAN** port
- 4 AC inlet

Note: If you are using a USB connection, make sure you insert the cable in the correct orientation.

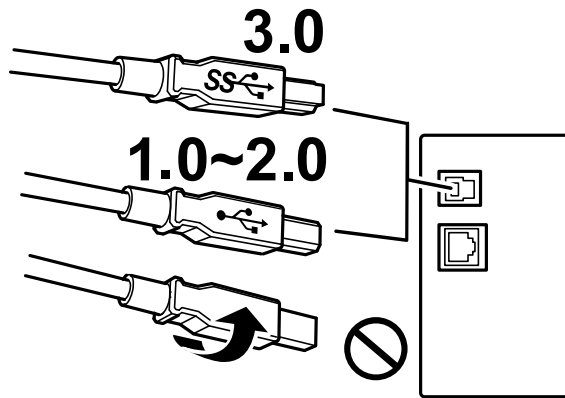

Extended Interface Board

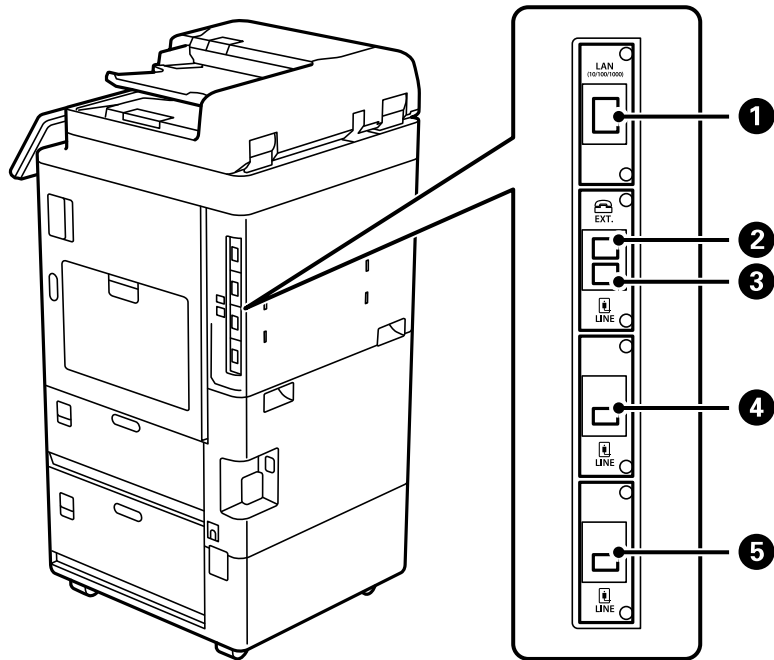

- 1 LAN
- 2 EXT. port
- 3 LINE1 port
- 4 LINE2 port
- 5 LINE3 port

Parent topic: [Product Parts Locations](#)

Product Parts - Options

Certain parts are labeled with a letter and number code.

Staple finisher

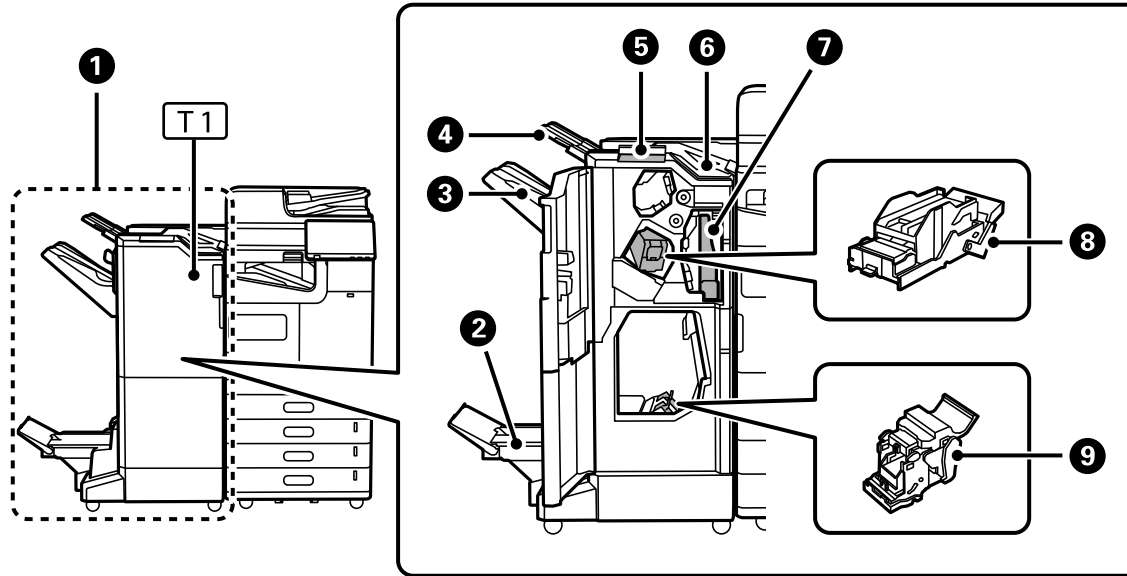

- 1 Staple finisher
- 2 Booklet tray
- 3 Finisher tray
- 4 Output tray (for received faxes)
- 5 Operation panel for manual stapling
- 6 Top output tray
- 7 Punch waste box (for use with optional hole punch unit)
- 8 Staple cartridge for flat stapling
- 9 Staple cartridge for saddle stitching

Inner finisher

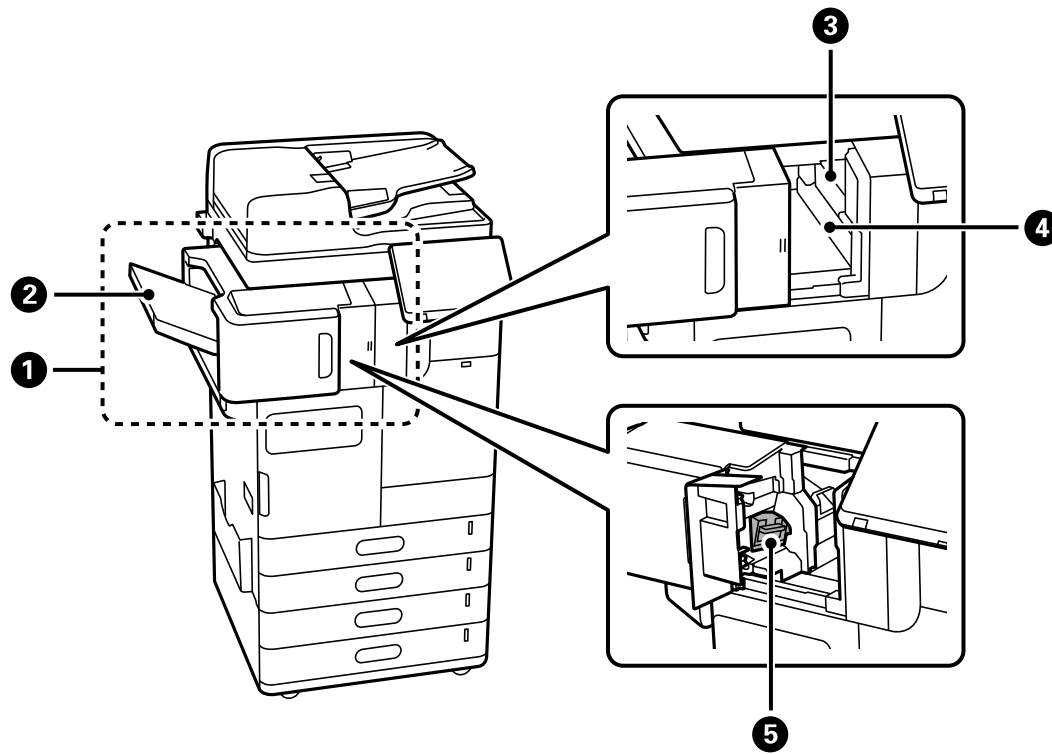

- 1 Inner finisher
- 2 Finisher tray
- 3 Hole punch unit (additional option)
- 4 Punch waste tray (for use with optional hole punch unit)
- 5 Staple cartridge for flat stitching

Other optional items

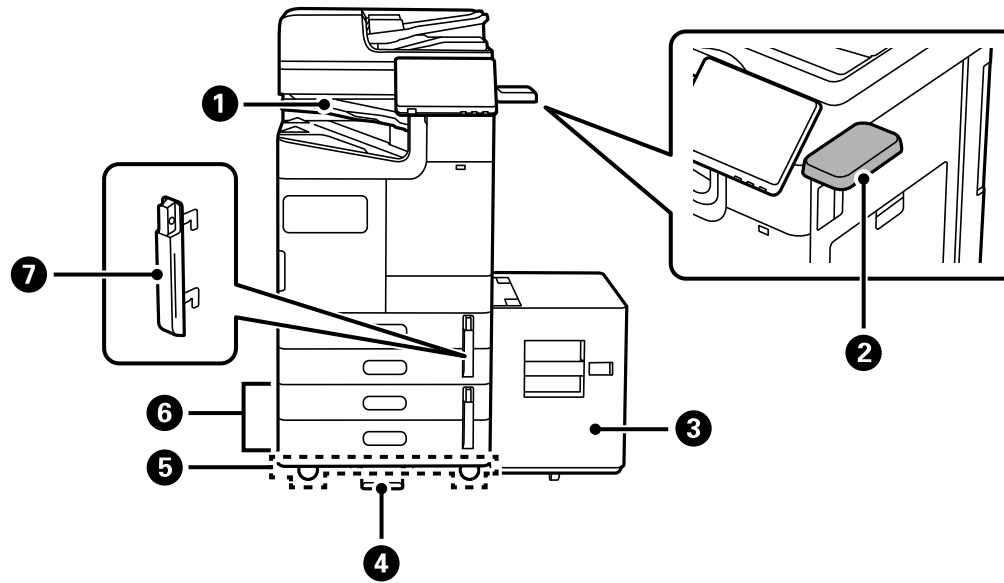

- 1 Inner tray
- 2 Authentication device table
- 3 High capacity tray
- 4 Stabilizer
- 5 Caster table
- 6 Optional dual cassette
- 7 Paper cassette lock

Parent topic: [Product Parts Locations](#)

Optional Accessories and Replacement Parts

You can purchase genuine Epson ink and paper at epson.com (U.S. sales), epson.ca (Canadian sales), or latin.epson.com (Latin American sales). You can also purchase supplies from an Epson authorized reseller. To find the nearest one, call 800-GO-EPSON (800-463-7766) in the U.S. or 800-807-7766 in Canada.

Note: Availability of accessories varies by country.

Option or part	Part number
Replacement maintenance box	C12C937181
Paper cassette lock	C12C936771
Optional dual cassette*	C12C936871
Cabinet	C12CFM70390
High-capacity tray*	C12C936911
Inner tray*	C12C936781
Inner finisher*	C12C936961 C12C937421
2/3 Hole punch kit for inner finisher*	C12C936981
2/4 Hole punch kit for inner finisher*	C12C936971
Staple finisher*	C12C936751 C12C937401 C12C937881
Saddle unit*	C12C938001
2/3 Hole punch kit for staple/booklet finisher*	C12C936821
2/4 Hole punch kit for staple/booklet finisher*	C12C936811
Staple cartridge for staple finisher	C12C935401
Staple cartridge for booklet/inner finisher	C12C937001
Wireless LAN interface*	C12C936861
Optional Super G3 fax board*	C12C935251
Optional Ethernet board*	C12C934471
Authentication device table*	C12C937381
Hard drive for mirroring*	C12C936791
OCR expansion board*/license	C12C936801 (board) EDS0200001 (license)

Option or part	Part number
Print Sets feature license	EDS0100001
Red Erase feature license	EDS0100002
IP Fax license	EDS0300001

* Must be installed by an Epson authorized reseller or technician.

Parent topic: [Product Parts Locations](#)

Using the Control Panel

See these sections to learn about the control panel and select control panel settings.

[Control Panel Buttons and Lights](#)

[Guide to the Home Screen](#)

[Entering Characters on the LCD Screen](#)

[Selecting the Date and Time](#)

[Selecting Your Country or Region](#)

[Changing LCD Screen Language](#)

[Adjusting Control Panel Sounds](#)

[Turning Off the Operation Time Out Setting](#)

[Adjusting the Screen Brightness](#)





[Checking the Print Counter](#)

[Using Presets](#)

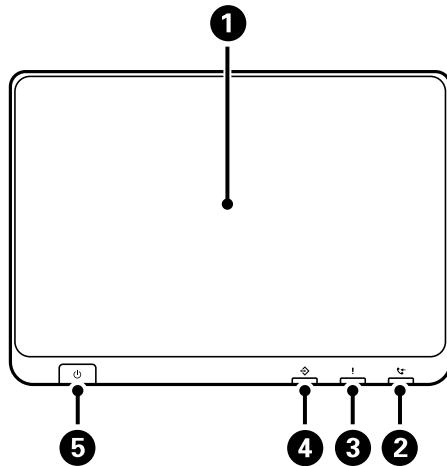
Parent topic: [Product Basics](#)

Control Panel Buttons and Lights



- 1 LCD screen
- 2  fax reception light
- 3  error light
- 4  data light
- 5  power button and light

Note: If the LCD screen is dark, touch the screen to wake the product from sleep mode.

[Status Icon Information](#)

Parent topic: [Using the Control Panel](#)



Related tasks

















[Changing the Sleep Timer Settings](#)





[Updating Firmware Using Web Config](#)

Status Icon Information

Your product displays status icons on the LCD screen for certain product status conditions. Press the

 or  icon to view or change the current network settings.

Icons	Description
 or Job/Status	Displays the Job Status , Printer Status , Power Consumption and Consumables/Others screens.
	No Ethernet connection.
	An Ethernet connection is established.
	No Wi-Fi connection.
	A Wi-Fi network error has occurred or the product is searching for a connection.
	A Wi-Fi connection is established. The number of bars indicates the connection's signal strength.
	No Wi-Fi Direct connection.
	A Wi-Fi Direct connection is established.
	The Mute setting is enabled. The product does not make any sound when you press buttons or select icons on the control panel. Select this icon to change the setting.
	Quiet Mode is enabled. Noise is reduced during printing, but the print speed may be reduced. Select this icon to change the setting.
	Quiet Mode is disabled. Select this icon to change the setting.
	Enables sleep mode and turns off the LCD screen.
	Displays the help screen with how-to and troubleshooting topics.
	Displays the Fax Data Information screen (models with optional fax board installed).
	Enters job interruption mode. Select again to turn this mode off.
	Displays the Paper Setting screen.
	Displays additional information or instructions, such as loading paper or placing a document.

Icons	Description
	The indicated setting has changed.
	There is a problem with the indicated setting. Select the icon to resolve the problem.
	Access to the product's functions are restricted to authorized users. Select the icon to log in using a user name and password. Contact your administrator if you do not know the login information.
	Access to the product's functions are restricted to authorized users and a user is currently logged in. Select the icon to log out of the current user account.
	A firmware update is available.

Parent topic: [Control Panel Buttons and Lights](#)

Guide to the Home Screen



- 1 Title of the currently displayed screen
- 2 Status icons

- 3 Menus (depending on installed options and settings, menus may be displayed in a different order or unavailable)
 - **Copy:** Allows you to copy documents
 - **Scan:** Allows you to scan documents and save them to various locations
 - **Fax:** Allows you to send faxes (if the optional fax board is installed)
 - **Presets:** Allows you to register frequently used settings for copying, scanning, or faxing
 - **Memory Device:** Allows you to print TIFF, JPG, or PDF data from a USB flash drive
 - **Storage:** Allows you to store data to the built-in hard drive and view, print, or save it
 - **Fax Box:** Allows you to store received faxes, documents to be sent, or documents for polling faxes
 - **Print Stored Documents:** Allows you to temporarily save jobs sent from the printer driver before printing them. You can print a password-protected job or test a print before printing multiple copies.
 - **Quick Dial:** Allows you to quickly send faxes to assigned contacts
 - **Settings:** Allows you to make settings for maintenance, printer settings, administration, and other operations
 - **Auto Cleaning:** Displays options to improve print quality and maintenance functions
 - **Useful Features:** Introduces useful functions
- 4 Displays the status of print jobs and the printer, including unread faxes, interrupted jobs, paper settings, and other information. Select **Job/Status** to display a list of current and pending print jobs.
- 5 Returns you to the home screen

Parent topic: [Using the Control Panel](#)

Related topics

[Copying](#)

[Scanning](#)

[Faxing](#)

Entering Characters on the LCD Screen

Follow these guidelines to enter characters on the LCD screen for passwords and other settings.

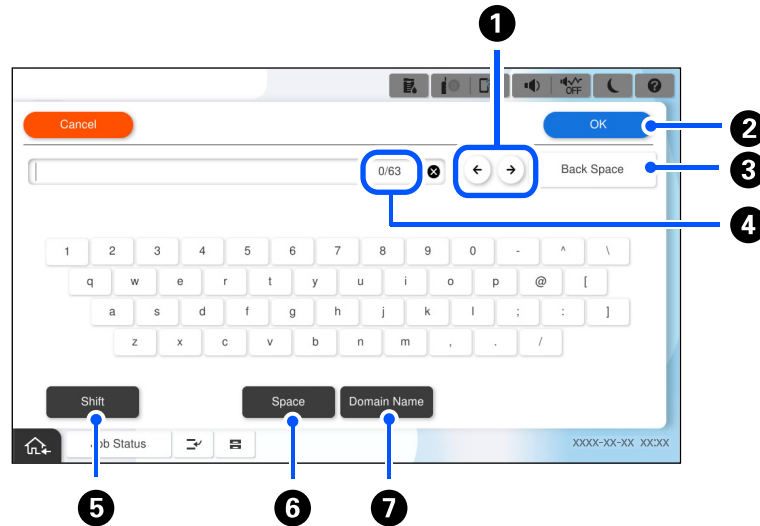

- 1 To move the cursor, select the left or right arrows.
- 2 When you are finished, select **OK**.
- 3 To delete the previous character, select **Back Space**.
- 4 Displays the current and maximum character count
- 5 To change the case of letters, select **Shift**.
- 6 To enter a space, select **Space**.
- 7 To enter a frequently used domain name or URL, select **Domain Name** and select it from the list.

Parent topic: [Using the Control Panel](#)

Selecting the Date and Time

Before using your product, select the current date, time, and daylight saving phase in your area, and choose your preferred date and time format.

Note: This setting can be locked by an administrator. If you cannot access or change this setting, contact your administrator for assistance.

1. Press the  home button, if necessary.
2. Select **Settings > General Settings > Basic Settings > Date/Time Settings**.
3. Select **Daylight Saving Time**.
4. Select the setting that applies to your area:
 - **Winter:** it is winter or your region does not use Daylight Saving Time (DST)
 - **Summer:** it is spring or summer and your region uses Daylight Saving Time (DST)

Note: If your region uses Daylight Saving Time (DST), you must change this setting to match the season. When you change from **Winter** to **Summer**, your product automatically sets its clock ahead one hour. When you change from **Summer** to **Winter**, it sets its clock back one hour.

5. Select **Date/Time**.
6. Select the date format you want to use.
7. Use the on-screen keypad to enter the current date and select **OK**.
8. Select the time format you want to use.
9. Use the on-screen keypad to enter the current time and select **OK**.

Parent topic: [Using the Control Panel](#)

Selecting Your Country or Region

Before using your product, select the country or region in which you are using your product.

Note: You must have the optional fax board installed to see this setting. If you change the country or region, your fax settings return to their defaults and you must select them again. This setting can be locked by an administrator. If you cannot access or change this setting, contact your administrator for assistance.

1. Press the  home button, if necessary.
2. Select **Settings > General Settings > Basic Settings > Country/Region**.
3. Scroll up or down, if necessary, and select your country or region.

You see a confirmation screen.

4. If the setting is correct, select **Yes**. (If not, select **No** and retry.)

Parent topic: [Using the Control Panel](#)

Changing LCD Screen Language

You can change the language used on the LCD screen.

Note: This setting can be locked by an administrator. If you cannot access or change this setting, contact your administrator for assistance.

1. Press the  home button, if necessary.
2. Select **Settings** > **General Settings** > **Basic Settings** > **Language**.
3. Select a language.

Parent topic: [Using the Control Panel](#)



Adjusting Control Panel Sounds

You can adjust the sound level heard when you press buttons on the control panel.

Note: This setting can be locked by an administrator. If you cannot access or change this setting, contact your administrator for assistance.

1. Press the  home button, if necessary.
2. Select **Settings** > **General Settings** > **Basic Settings** > **Sounds**.
3. Select **Mute** to turn off all control panel sounds, then go to step 7.
4. Select **Normal Mode** or **Quiet Mode** to adjust control panel sounds.

Note: You can also select the  icon on the home screen to adjust sounds.

5. Select **Button Press**.
6. Select  to decrease or  to increase the sound and select **OK** when you are finished.
7. Select the back arrow to exit.

Note: You can also adjust the **Sound Type** and the sound level for various product functions.

Parent topic: [Using the Control Panel](#)

Turning Off the Operation Time Out Setting

The Operation Time Out setting causes the LCD screen to return to the Home screen after a few minutes of inactivity. This feature is enabled by default, but you can turn it off.

Note: This setting can be locked by an administrator. If you cannot access or change this setting, contact your administrator for assistance.

1. Press the  home button, if necessary.
2. Select **Settings** > **General Settings** > **Basic Settings** > **Operation Time Out** .
3. Set **Operation Time Out** to **Off**.

Parent topic: [Using the Control Panel](#)

Adjusting the Screen Brightness



You can adjust the brightness of the LCD screen.

1. Press the  home button, if necessary.
2. Select **Settings** > **General Settings** > **Basic Settings** > **LCD Brightness**.
3. Select the – or + icons to decrease or increase the brightness.
4. Select **OK** to exit.

Parent topic: [Using the Control Panel](#)

Checking the Print Counter

You can check the total number of prints, black-and-white prints, and color prints that have been printed.

1. Press the  home button, if necessary.
2. Select **Settings** > **Print Counter**.
3. Select **Print Sheet** if you want to print out the counter results.
4. Press the  home button to exit.

Parent topic: [Using the Control Panel](#)

Using Presets

You can save frequently used copy, fax (models equipped with the optional fax board), and scan settings as presets. This lets you easily reuse them whenever necessary.

Note: Presets can be locked by an administrator. If you cannot access or change presets, contact your administrator for assistance.

1. Press the  home button, if necessary.
2. Select **Presets**.
3. Select **Add New**.

Note: You can save up to 50 presets.

4. Select the function for which you want to set up a preset, such as **Copy**.
5. Select the settings you want to save and select **Save**.
6. Select the **Name** field.
7. Use the on-screen keyboard to enter a name for the preset and select **OK**.
8. When you are done confirming the settings, select **OK**.



When you copy, fax (models with optional fax board installed), or scan, you can use the preset by selecting the  icon and selecting your preset name from the list.

Parent topic: [Using the Control Panel](#)

Checking for Software Updates

It's a good idea to check Epson's support website occasionally for free updates to your product software. Visit epson.com/support (U.S.), epson.ca/support (Canada), or latin.epson.com/support (Latin America) and select your product.

Note: Your printer is designed to work only with genuine Epson-brand ink cartridges. Other brands of ink cartridges and ink supplies are not compatible and, even if described as compatible, may not function properly or at all. Epson periodically provides firmware updates to address issues of security, performance, minor bug fixes and ensure the printer functions as designed. These updates may affect the functionality of third-party ink. Non-Epson branded or altered Epson cartridges that functioned prior to a firmware update may not continue to function.

- **Windows:** Your printer software automatically checks for updates. You can also manually update the software by selecting **Software Update** here:
 - Accessing the Windows Desktop and right-clicking the  icon for your product in the right side of the Windows taskbar, or clicking the up arrow and right-clicking .
 - On the **Maintenance** tab in the printer settings window

You can also update the software by selecting **EPSON Software Updater** in the **EPSON** or **Epson Software** program group, accessible by the **Start** button, or on the **Start** or **Apps** screens, depending on your version of Windows.
- **OS X:** You can manually update the software by opening the **Applications > Epson Software** folder and selecting **EPSON Software Updater**.
- **macOS 10.12.x to 14.x:** You can manually update the software by opening the **App Store**, selecting **Updates**, searching for a software update option for Epson Software, and selecting **Update**.

Parent topic: [Product Basics](#)

Using Power Saving Settings

Your product enters sleep mode automatically and turns off the LCD screen if it is not used for a period of time. You can make the time period shorter and select other options to save energy and resources.

[Changing the Sleep Timer Settings](#)

[Changing the Power Off Timer Settings](#)

Parent topic: [Product Basics](#)

Changing the Sleep Timer Settings

You can adjust the time period before your product enters sleep mode and turns off the LCD screen.

Note: This setting can be locked by an administrator. If you cannot access or change this setting, contact your administrator for assistance.

1. Press the  home button, if necessary.
2. Select **Settings > General Settings > Basic Settings > Sleep Timer**.

Note: Enter the administrator password, if necessary.

3. Do one of the following:
 - Select the – or + icon to decrease or increase the number of minutes.
 - Select the number of minutes on the LCD screen, select the number of minutes from the on-screen keypad, and select **OK**.
4. Select **OK**.

Parent topic: [Using Power Saving Settings](#)

Changing the Power Off Timer Settings

You can have the product turn off automatically if it is not used for a specified period of time.

Note: This setting can be locked by an administrator. If you cannot access or change this setting, contact your administrator for assistance.

1. Press the  home button, if necessary.
2. Select **Settings > General Settings > Basic Settings > Power Off Timer**.
3. Select a time period between **30minutes** and **12h** (12 hours).

Parent topic: [Using Power Saving Settings](#)

Epson Connect Solutions for Smartphones, Tablets, and More

Use your smartphone, tablet, or computer to print and scan documents, photos, emails, and web pages from your home, office, or even across the globe.

Note: If you are using your Epson product with the Windows 10 S operating system, you cannot use the software described in this section. You also cannot download and install any Epson product software from the Epson website for use with Windows 10 S; you must obtain software only from the Windows Store.

Print from anywhere with these Epson Connect solutions:

- Epson Email Print
- Epson Remote Print

Scan and send a file as an email or upload it to an online service directly from your Epson product with Epson Scan to Cloud.

[Setting Up Epson Connect Services](#)

[Using Epson Email Print](#)
[Using Epson Remote Print](#)
[Using Epson Scan to Cloud](#)

Parent topic: [Product Basics](#)

Related topics

[Wi-Fi or Wired Networking](#)

Setting Up Epson Connect Services

If you did not activate your product's email address for use with Epson Connect when you set up your product, you can activate it using the product control panel.

1. Press the  home button, if necessary.
2. Select **Settings** > **General Settings** > **Web Service Settings** > **Epson Connect Services**.
3. Select **Register**.
4. Follow the instructions on the screen to activate your product's email address.

Parent topic: [Epson Connect Solutions for Smartphones, Tablets, and More](#)

Related topics

[Wi-Fi or Wired Networking](#)

Using Epson Email Print

With Epson Email Print, you can print from any device that can send email, such as your smartphone, tablet, or laptop. Just activate your product's unique email address. When you want to print, attach a PDF, Microsoft Office document, or photo to an email and send it to your product. Both the email and the attachments will print automatically.

1. Connect your product to your network. See the link below.
2. If you did not already set up Email Print when you installed your product software, see the link below to use your product control panel to activate your unique email address. Or visit epson.com/connect (U.S.), epson.ca/connect (Canada), or latin.epson.com/connect (Latin America) to learn more about Email Print, create your Epson Connect account, and register your product to the Epson Connect service.
3. Now you are ready to send and print emails to your product's Email Print address.

Note: Go to epsonconnect.com and log into your Epson Connect account to personalize your product's email, adjust print settings, and set up other Epson Connect services.

Parent topic: [Epson Connect Solutions for Smartphones, Tablets, and More](#)

Related tasks

[Setting Up Epson Connect Services](#)

Related topics

[Wi-Fi or Wired Networking](#)

Using Epson Remote Print

With Epson Remote Print software, you can print from your laptop or desktop computer to an Epson Email-enabled product anywhere in the world.

1. Connect your Epson product to your wireless network. See the link below.
2. If you did not already set up an Epson Connect account when you installed your product software, visit epsonconnect.com to create your account and register your product to the Epson Connect service.

Note: Make a note of your product's email address.

3. Visit epsonconnect.com to learn more about Remote Print and how to download the Remote Print Driver software.
4. Download and install the Remote Print software.
5. Enter the email address and optional access key of your Epson product during Remote Print setup.
6. Now you are ready to print remotely. Select the print command in your laptop or desktop computer application and choose the Remote Print option for your Epson product.

Parent topic: [Epson Connect Solutions for Smartphones, Tablets, and More](#)

Related tasks

[Setting Up Epson Connect Services](#)

Related topics

[Wi-Fi or Wired Networking](#)

Using Epson Scan to Cloud

The Epson Scan to Cloud service allows you to scan and send a file as an email or upload it to an online service directly from your Epson product. Register an email address or online services such as Box, DropBox, Evernote, or Google Drive with your Epson Connect account.

1. Connect your Epson product to your network. See the link below.

2. If you did not already set up an Epson Connect account when you installed your product software, visit epsonconnect.com to create your account and register your product to the Epson Connect service.

Note: Make a note of your product's email address and password.

3. Visit epsonconnect.com to sign into your account with the email address and password you selected.
4. Select your product, select **Scan to Cloud**, and select **Destination List**.
5. Click **Add**, then follow the instructions on the screen to create your destination list.
6. Now you are ready to use Scan to Cloud. Select the setting for scanning to Scan to Cloud on your Epson product control panel.

Parent topic: [Epson Connect Solutions for Smartphones, Tablets, and More](#)

Related tasks

[Setting Up Epson Connect Services](#)

Related topics

[Wi-Fi or Wired Networking](#)

Using the Epson Smart Panel Mobile App

Use this free Apple and Android app to set up and control your Epson product. Epson Smart Panel also lets you check product status.

Note: App features may vary depending on your Epson product.

1. Visit epson.com/connect (U.S.), epson.ca/connect (Canada), or latin.epson.com/connect (Latin America) to learn more about Epson Smart Panel and check the compatibility of your mobile device.
2. Download Epson Smart Panel from the Apple App Store or Google Play.
3. Do one of the following:
 - If your Epson product is already connected to a wireless network, connect your mobile device to the same network. Then open Epson Smart Panel and select your Epson product, if necessary.
 - If your Epson product is not connected to a wireless network, connect your mobile device to the network you want to use, then open Epson Smart Panel and follow the instructions to set up your Epson product.

Now you are ready to control your Epson product with your mobile device.

Parent topic: [Product Basics](#)

Related tasks

[Setting Up Epson Connect Services](#)

Related topics

[Wi-Fi or Wired Networking](#)

Using AirPrint

AirPrint enables instant wireless printing from iPhone, iPad, iPod touch, and Mac without the need to install drivers or download software.



Note: If you disabled paper configuration messages on your product control panel, you cannot use AirPrint. See the link below to enable the messages, if necessary.

1. Load paper in your product.
2. Set up your product for wireless printing. See the link below.
3. Connect your Apple device to the same wireless network that your product is using.
4. Print from your device to your product.

Note: For details, see the AirPrint page on the Apple website.

Parent topic: [Product Basics](#)

Related references

[Paper Source Settings Options](#)

Related topics

[Wi-Fi or Wired Networking](#)

Android Printing Using the Epson Print Enabler

You can wirelessly print your documents, emails, photos, and web pages right from your Android phone or tablet (Android v4.4 or later). With a few taps, your Android device will discover your nearby Epson product and print.

Note: Operations may differ depending on the device.

1. Connect your Epson product to your wireless network. See the link below.
2. On your Android device, download the Epson Print Enabler plug-in from Google Play.
3. Go to **Settings** on your Android device, select **Printing**, and enable the Epson plug-in, if necessary.
4. Connect your Android device to the same wireless network as your product.
5. Now you are ready to print. From an Android application such as Chrome or Gmail, tap the menu icon and print whatever is on the screen.

Note: If you do not see your product, tap **All Printers** and select your product.

Parent topic: [Product Basics](#)

Related tasks

[Setting Up Epson Connect Services](#)

Related topics

[Wi-Fi or Wired Networking](#)

Using the Mopria Print Service

You can use the Mopria Print Service to print from your Android phone or tablet (Android v4.4 or later) to your Epson product or any Mopria-certified product from other manufacturers. You can download the Mopria Print Service from Google Play.

Note: For details on the Mopria Print Service, [click here](#) (U.S.) or [click here](#) (Canada). Some Amazon Fire tablets also use the Mopria Print Service.

1. Connect your Epson product to your wireless network. See the link below.
2. On your Android device, download the Mopria Print Service app from Google Play.

Note: On some Samsung Galaxy devices, Mopria may come preinstalled.

3. Go to **Settings** on your Android device, select **Printing**, and enable the Mopria Print Service, if necessary.
4. Connect your Android device to the same wireless network as your product.
5. Now you are ready to print. From an Android application such as Chrome or Gmail, tap the menu icon and select **Print**. Then select **All printers**, select your Epson product, adjust your print settings, and print.

Parent topic: [Product Basics](#)

Related tasks

[Setting Up Epson Connect Services](#)

Related topics

[Wi-Fi or Wired Networking](#)

Wi-Fi or Wired Networking

See these sections to use your product on a Wi-Fi or wired network.

[Network Security Recommendations](#)

[Wi-Fi Infrastructure Mode Setup](#)

[Wi-Fi Direct Mode Setup](#)

[Wi-Fi Protected Setup \(WPS\)](#)

[Printing a Network Status Sheet](#)

[Printing a Network Connection Report](#)

Network Security Recommendations

To help deter unauthorized access to your product over a network, you should protect your network environment using appropriate security measures.

Security measures such as these can help deter threats such as loss of user data, use of telephone and fax lines, and other intrusions:

- **Enable security on your wireless LAN**

Enable the appropriate security on the wireless LAN you plan to use with your product. Network security such as a network password can deter interception of traffic over the wireless LAN. Your router may already have a default password enabled by your Internet service provider (ISP). See your ISP and router documentation for instructions on how to change the default password and better secure your network.

- **Connect your product only to a network protected by a firewall**

Connecting your product directly to the Internet may leave it vulnerable to security threats. Instead, connect it to a router or other network connection protected by a firewall. Your router may already have a firewall set up by your Internet service provider; check with your ISP for confirmation. For best results, set up and use a private IP address for your network connection.

- **Change the default administrator password on your product**

If your product has the option to set an administrator password, change the default administrator password to deter access by unauthorized users to personal data stored on your product, such as IDs, passwords, and contact lists.

Parent topic: [Wi-Fi or Wired Networking](#)

Related tasks

[Accessing the Web Config Utility](#)

Wi-Fi Infrastructure Mode Setup

You can set up your product to communicate with your computer using a wireless router or access point. The wireless router or access point can be connected to your computer over a wireless or wired network.

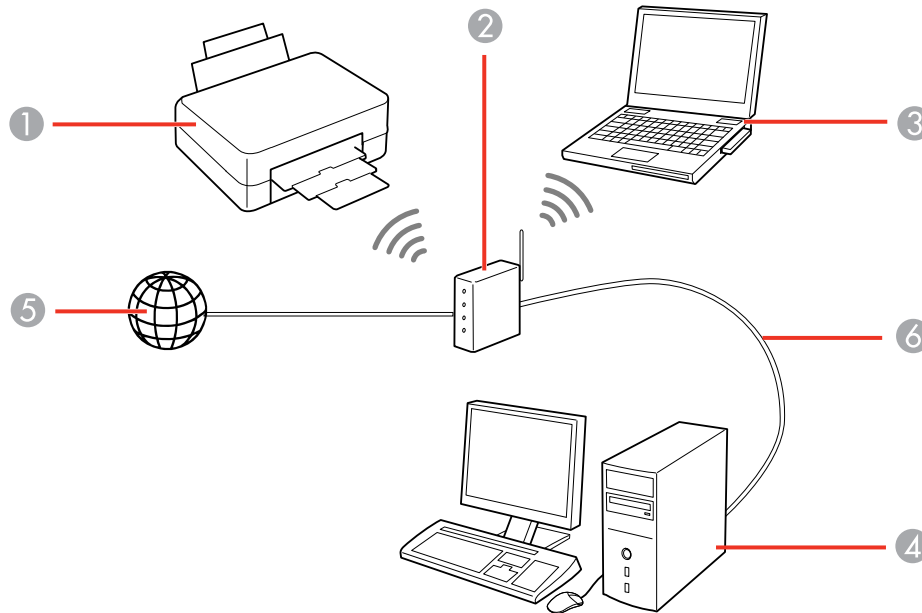

- 1 Epson product
- 2 Wireless router or access point
- 3 Computer with a wireless interface
- 4 Computer
- 5 Internet
- 6 Ethernet cable (used only for wired connection to the wireless router or access point)

[Selecting Wireless Network Settings from the Control Panel](#)

Parent topic: [Wi-Fi or Wired Networking](#)



Selecting Wireless Network Settings from the Control Panel

You can select or change wireless network settings using your product control panel.

To install your product on a wireless network, install the necessary software by downloading it from the Epson website. The installer program guides you through network setup.

Note: This feature requires the optional wireless LAN interface.

Note: Breakdown or repair of this product may cause loss of fax and network data and settings. Epson is not responsible for backing up or recovering data and settings during or after the warranty period. We recommend that you make your own backup or print out your fax and network data and settings.

1. Press the  home button, if necessary.
2. Select the  icon.
3. Select **Router**.
4. Select **Start Setup** or **Change**.
5. Select **Wi-Fi Setup**.
6. Select **Wi-Fi Setup Wizard**.
7. Select the name of your wireless network or select **Enter Manually** to enter the name manually. Use the on-screen keyboard to enter your network name.
8. Select the **Enter Password** field and enter your wireless password using the on-screen keyboard.

Note: The network name and password are case sensitive. Be sure to correctly enter uppercase and lowercase letters, and numeric or special characters.

- To move the cursor, press the left or right arrows.
 - To change the case of letters, select **Shift**.
 - To delete the previous character, select **Back Space**.
 - To enter a space, select **Space**.
9. Select **OK** when you finish entering your password.
 10. Confirm the displayed network settings and select **Start Setup** to save them.
A message appears when setup is complete.

11. If setup was unsuccessful, select **Print Check Report** to print a network setup report, or select **Re-enter** to try again.
12. Press the  home button to exit.

You see the  icon on the LCD screen and should be able to connect to your product directly from your computer or device, and then print. If you are printing from a computer, make sure you installed the network software from the Epson website.

Note: If you don't see the  icon, you may have selected the wrong network name or entered the password incorrectly. Repeat these steps to try again.

Parent topic: [Wi-Fi Infrastructure Mode Setup](#)

Wi-Fi Direct Mode Setup

You can set up your product to communicate directly with your computer or another device without requiring a wireless router or access point. In Wi-Fi Direct Mode, the product itself acts as a network access point for up to 8 devices.

Note: This feature requires the optional wireless LAN interface.

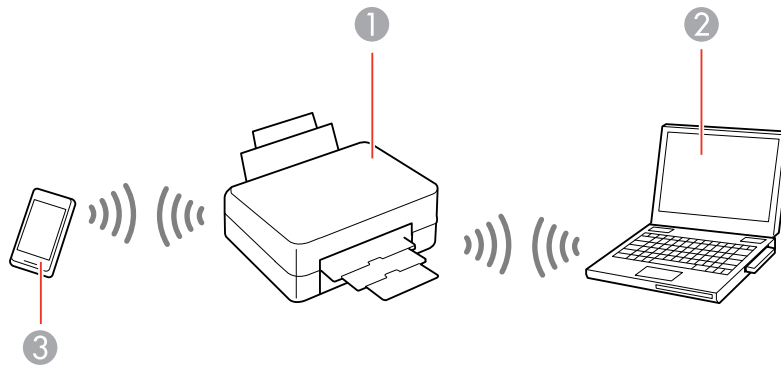

- 1 Epson product
- 2 Computer with a wireless interface

3 Other wireless device

Note: The product normally uses W52 (36ch) as the channel when connecting to Wi-Fi Direct (Simple AP). Since the channel for wireless LAN (Wi-Fi) connection is selected automatically, the channel used may differ when used at the same time as a Wi-Fi Direct connection. Sending data to the printer may be delayed if the channels are different. If it does not interfere with use, connect to the SSID in the 2.4 GHz band. In the 2.4 GHz frequency band, the channels used will match.

When setting the wireless LAN to 5 GHz, we recommend disabling Wi-Fi Direct.

[Enabling Wi-Fi Direct Mode](#)

[Modifying the Wi-Fi Direct Network Name or Password](#)



Parent topic: [Wi-Fi or Wired Networking](#)

Enabling Wi-Fi Direct Mode

You can enable Wi-Fi Direct mode to allow direct communication between your product and computer or other devices without a wireless router or access point.

Note: This feature requires the optional wireless LAN interface.

Note: This product normally uses W52 (36ch) as the channel when connecting to Wi-Fi Direct (Simple AP). Since the channel for wireless LAN (Wi-Fi) connection is selected automatically, the channel used may differ when used at the same time as a Wi-Fi Direct connection. Sending data to the printer may be delayed if the channels are different. If it does not interfere with use, connect to the SSID in the 2.4 GHz band. In the 2.4 GHz frequency band, the channels used will match. When setting the wireless LAN to 5 GHz, we recommend disabling Wi-Fi Direct.

1. Press the  home button, if necessary.
2. Press the  icon.
3. Select **Wi-Fi Direct**.
4. Select **Start Setup**.
5. Do one of the following:
 - For iOS devices, select **iOS**. Scan the QR code with the camera app on your device and follow the instructions on your device. Select **Next** on the LCD screen to verify the product information, then

open the Epson Smart Panel app on your device and select the product displayed on the LCD screen. Select **Complete** on the LCD screen.

- For Android devices, select **Android**. Open the Epson Smart Panel app on your device and follow the on-screen instructions. Select **Complete** on the LCD screen.
- For other types of devices, select **Other OS Devices**. Use your device to select the Wi-Fi network name (SSID) displayed on the LCD screen, and enter the password shown. Select **Next** on the LCD screen to verify the product information, then open the Epson Smart Panel app on your device and select the product displayed on the LCD screen. Select **Complete** on the LCD screen.

Note: If you want to change the network name or password, or disable Wi-Fi Direct, select **Change**.

6. When you are finished, the **Network Connection Settings** screen returns.
You should see the number of connected devices (for example, **1/8**).
7. Select the back arrow to return to the home screen.

The  Wi-Fi Direct icon is displayed on the LCD screen and indicates if Wi-Fi Direct is enabled on the product.



Parent topic: [Wi-Fi Direct Mode Setup](#)

Related tasks

[Using the Epson Smart Panel Mobile App](#)

Modifying the Wi-Fi Direct Network Name or Password

You can modify the Wi-Fi Direct name and password to create a more descriptive and secure Wi-Fi Direct network.

1. Press the  home button, if necessary.
2. Select the  icon.
3. Select **Wi-Fi Direct**.
4. Select **Start Setup**.
5. Select **Change**.
6. Do one of the following:
 - To change the Wi-Fi Direct network name, select **Change Network Name**, and select **Yes**. Select **Change**, then use the on-screen keyboard to enter the new network name.

- To change the Wi-Fi Direct password, select **Change Password**, then select **Yes**. Use the on-screen keyboard to enter your new Wi-Fi Direct password.

Note: Your password must be at least 8 and no more than 22 characters long.

Note: If you have already connected devices or computers to your product via Wi-Fi Direct, they will be disconnected when you change the network name or password.

7. Use your computer or wireless device to select the Wi-Fi network name (SSID) displayed on the LCD screen, then enter the password shown.

Note: Make a note of the SSID and password that appear.

8. Press the  home button to return to the home screen.

Computers and wireless devices can now access the product using the new network name and password.

Parent topic: [Wi-Fi Direct Mode Setup](#)

Wi-Fi Protected Setup (WPS)

If your network uses a WPS-enabled wireless router or access point, you can quickly connect your product to the network using Wi-Fi Protected Setup (WPS).

Note: To check if your router is WPS-enabled, look for a button labeled **WPS** on your router or access point. If there is no hardware button, there may be a virtual WPS button in the device's software. Check your network product documentation for details.

[Using WPS to Connect to a Network](#)



Parent topic: [Wi-Fi or Wired Networking](#)

Using WPS to Connect to a Network

If you have a WPS-enabled wireless router or access point, you can use Wi-Fi Protected Setup (WPS) to connect your product to the network.

Note: This feature requires the optional wireless LAN interface.

1. Press the  home button, if necessary.

2. Select the   icon.
3. Select **Router**.
4. Select **Start Setup** or **Change**.
5. Select **Wi-Fi Setup**.
6. Select **Push Button Setup (WPS)**.
7. Follow the instructions on the LCD screen to complete WPS setup.

Note: You must complete the on-screen instructions and select **Start Setup** within two minutes.

8. Press the  home button to exit.

You see the  icon on the LCD screen and should be able to connect to your product directly from your computer or device, and then print. If you are printing from a computer, make sure you installed the network software from the Epson website.

Note: If you don't see the  icon, repeat these steps to try again.

Parent topic: [Wi-Fi Protected Setup \(WPS\)](#)

Printing a Network Status Sheet

You can print a network status sheet to help you determine the causes of any problems you may have using your product on a network.

1. Press the  home button, if necessary.
2. Select **Settings** > **General Settings** > **Network Settings** > **Network Status** > **Print Status Sheet**.
3. Select **Print**.

Examine the settings shown on the network status sheet to diagnose any problems you have.

Parent topic: [Wi-Fi or Wired Networking](#)

Printing a Network Connection Report

You can print a network connection report to view solutions to any problems you may have using your product on a network.

1. Press the  home button, if necessary.
2. Select **Settings** > **General Settings** > **Network Settings** > **Connection Check**.
The product checks the network connection and displays the result.
3. Select **Yes** to print a network connection report.

Note: Select **No** or **Close** to return to the **Network Settings** menu without printing a report.

4. Select **Print**.

Examine the error codes and solutions shown on the network connection report.

[Network Connection Report Codes and Messages](#)

Parent topic: [Wi-Fi or Wired Networking](#)

Network Connection Report Codes and Messages

Check the error codes and messages on the network connection report to solve problems you may encounter with network connections. The tables here list solutions to problems based on the error codes and messages that may appear at the top of the report.

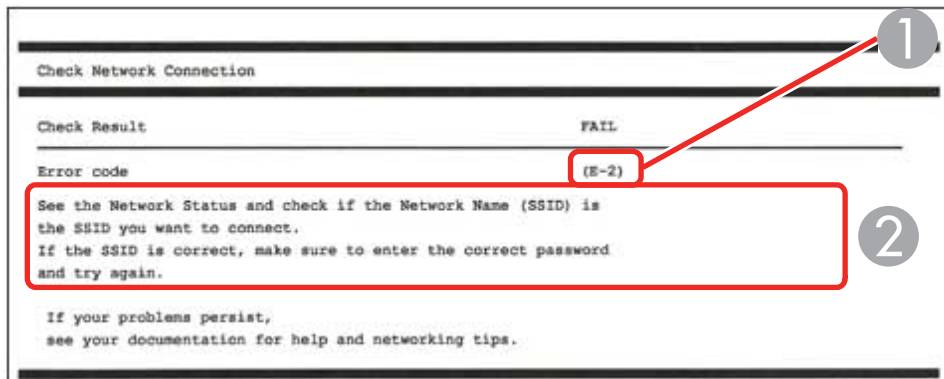

- 1 Error code
- 2 Message

Note: Error codes and messages listed here may not all apply to your product.

Error Codes and Messages

Error code and message	Solution
E-1 Confirm that the network cable is connected and network devices such as a hub, router, or access point are turned on.	Make sure your router, access point, and/or hub are turned on, and the network cable is securely connected to your device and your product. If you are trying to set up Wi-Fi, remove the network cable and set up Wi-Fi again. Ethernet and Wi-Fi cannot be connected at the same time.

Error code and message	Solution
<p>E-2, E-3, or E-7</p> <p>No wireless network names (SSID) found. Confirm that the router/access point is turned on and the wireless network (SSID) is set up correctly. Contact your network administrator for assistance.</p> <p>No wireless network names (SSID) found. Confirm that the wireless network name (SSID) of the PC you wish to connect is set up correctly. Contact your network administrator for assistance.</p> <p>Entered security key/password does not match the one set for your router/access point. Confirm security key/password. Contact your network administrator for assistance.</p>	<p>Check the following:</p> <ul style="list-style-type: none"> • Make sure your router or access point is turned on and is correctly connected to your computer or network device. • Turn off the router or access point, wait about 10 seconds, and turn it on again. • Move your product closer to your router or access point, and remove any obstacles between them. Also move your product away from devices such as wireless phones or microwaves. • Confirm that the SSID shown on the network connection report matches the label on your router or access point. Also make sure your SSID uses only ASCII characters and symbols, or your product cannot display the SSID correctly. • If you are trying to connect using the WPS push button method, make sure your router or access point supports it. • If you are using a network password, check the label on your router or access point to confirm that you are using the correct password, or check with your network administrator or router/access point documentation. • If you are connecting to a smart device that generates an SSID, check the device documentation for the SSID and password you should use. • If your wireless connection suddenly disconnects, and another smart device was added to the network using a WPS push button method, or your network was set up using a non-WPS push button method, try downloading and installing your product software again.

Error code and message	Solution
<p>E-5</p> <p>Security mode (e.g. WEP, WPA) does not match the current setting of the printer. Confirm security mode, and contact the network administrator for assistance.</p>	<p>If the security on your router or access point is not one of the following types, change the type of security on your router or access point and reset your product's network settings.</p> <ul style="list-style-type: none"> • WEP-64 bit (40 bit) • WEP-128 bit (104 bit) • WPA PSK (TKIP/AES); also known as WPA Personal • WPA2 PSK (TKIP/AES); also known as WPA2 Personal • WPA (TKIP/AES) • WPA2 (TKIP/AES) • WPA3-SAE (AES) • WPA2/WPA3-Enterprise
<p>E-6</p> <p>MAC address of your printer may be filtered. Check whether your router/access point has restrictions such as MAC address filtering. See the documentation of the router/access point or contact your network administrator for assistance.</p>	<p>If your router or access point has MAC address filtering enabled, register your product's MAC address so it is not filtered. Locate the MAC address on the network connection report and check your router or access point documentation for instructions.</p> <p>If your router or access point is using shared authentication with WEP security, confirm that you are using the correct authentication key and index.</p> <p>If your router or access point limits the number of connected devices, raise the connection limit. See your router or access point documentation for instructions.</p>
<p>E-8</p> <p>Incorrect IP address is assigned to the printer. Confirm IP address setup of the network device (hub, router, or access point). Contact your network administrator for assistance.</p>	<p>If your product's Obtain IP Address setting is set to Auto, enable DHCP on your router or access point. If it is set to Manual, the IP address may be out of range or on a different network segment; set a valid IP address using your product control panel or the Web Config utility.</p> <p>You can also try turning off your product and the router or access point, waiting about 10 seconds, and turning them on again.</p>

Error code and message	Solution
<p>E-9 Confirm the connection and network setup of the PC or other device. Connection using the EpsonNet Setup is available. Contact your network administrator for assistance.</p>	<p>Make sure your computer or network device are turned on. Also make sure that you can access the Internet and other devices on the same network from the devices you are trying to connect to your product.</p> <p>If you still cannot connect to your product, turn off your router or access point, wait about 10 seconds, and turn it on again. Download and install your product software again to reset your network settings.</p>
<p>E-10 Confirm IP address, subnet mask, and default gateway setup. Connection using the EpsonNet Setup is available. Contact your network administrator for assistance.</p>	<p>Make sure other devices on the network are turned on and do the following:</p> <ul style="list-style-type: none"> • If your product's Obtain IP Address setting is set to Manual, check the IP address, subnet mask, and default gateway addresses on the network connection report to see if they are correct. If not, correct the settings. • If DHCP is enabled, set your product's Obtain IP Address setting to Auto. If you want to use the DHCP-assigned address as a static address, set the Obtain IP Address setting to Manual, enter the product's IP address as listed on the network connection report, and set the subnet mask to 255.255.255.0. <p>If you still cannot connect to your product, turn off your router or access point, wait about 10 seconds, and turn it on again.</p>
<p>E-11 Setup is incomplete. Confirm default gateway setup. Connection using the EpsonNet Setup is available. Contact your network administrator for assistance.</p>	<p>If you set your product's TCP/IP Setup setting to Manual, check that the default gateway address listed on the network connection report is correct. Also turn on the device that is set as the default gateway.</p>

Error code and message	Solution
<p>E-12</p> <p>Confirm the following:</p> <ul style="list-style-type: none"> -Entered security key/password is correct -Index of the security key/password is set to the first number -IP address, subnet mask, or default gateway setup is correct <p>Contact your network administrator for assistance.</p>	<p>Make sure other devices on the network are turned on and do the following:</p> <ul style="list-style-type: none"> • Make sure the IP address, subnet mask, and default gateway addresses are correct, if you are entering them manually. • Confirm that the subnet mask and default gateway addresses for other devices are the same. • Make sure the IP address does not conflict with other devices. <p>If you still cannot connect to your product, do the following:</p> <ul style="list-style-type: none"> • Turn off your router or access point, wait about 10 seconds, and turn it on again. • Download and install your product software again to reset your network settings. • If your router or access point uses WEP security with several registered passwords, make sure that the first registered password is set on your product.
<p>E-13</p> <p>Confirm the following:</p> <ul style="list-style-type: none"> -Entered security key/password is correct -Index of the security key/password is set to the first number -Connection and network setup of the PC or other device is correct <p>Contact your network administrator for assistance.</p>	<p>Make sure your router, access point, and/or hub are turned on. Also make sure the TCP/IP setup on your router, access point, and/or hub is not set manually; this may cause your product's network settings to differ from the manually set up devices.</p> <p>If you still cannot connect to your product, do the following:</p> <ul style="list-style-type: none"> • Turn off your router or access point, wait about 10 seconds, and turn it on again. • Download and install your product software again to reset your network settings. • If your router or access point uses WEP security with several registered passwords, make sure that the first registered password is set on your product.

Network Environment Messages

Message	Solution
The Wi-Fi environment needs to be improved. Turn the wireless router off and then turn it on. If the connection does not improve, see the documentation for the wireless router.	Move your product closer to your router or access point, and remove any obstacles between them. Then turn off your router or access point, wait about 10 seconds, and turn it back on again. If you still cannot connect to your product, check the documentation that came with your router or access point for solutions.
*No more devices can be connected. Disconnect one of the connected devices if you want to add another one.	You can connect up to 8 computers or other devices to your product using a Wi-Fi Direct (Simple AP) connection. If you want to add another device, disconnect an existing connected device first.
The same SSID as Wi-Fi Direct exists in the environment. Change the Wi-Fi Direct SSID if you cannot connect a smart device to the printer.	Change the Wi-Fi Direct SSID. You can change the network name after "DIRECT-XX-". The custom name must be 22 characters or less.

Parent topic: [Printing a Network Connection Report](#)

Enabling Epson Universal Print Driver (PCL) or PostScript Printing

Before enabling Epson Universal Print Driver (PCL) or PostScript printing on your product, make sure you have installed the software from the Epson website.

To download the Epson Universal Print Driver or PostScript drivers, visit epson.com/support (U.S.), epson.ca/support (Canada), or latin.epson.com/support (Latin America) and select your product.

[Installing the Epson Universal Print Driver - Windows](#)

[Installing the PostScript \(PS3\) Printer Software - Windows](#)

[Installing the PostScript \(PS3\) Printer Software - Mac](#)

[Selecting PDL \(Page Description Language\) Settings](#)

[Selecting Printer Language and Interface Settings](#)

[Printing a PCL or PS3 \(PostScript\) Status Sheet](#)

Installing the Epson Universal Print Driver - Windows

The Epson Universal Print Driver supports multiple printer languages, such as PCL and ESC/P-R, and can be installed on a Windows computer.

Note: Make sure your product is turned on and connected to the same network as your computer before installing the printer software. Depending on your model, not all printer languages may be supported.

1. To download the **EPSON Universal Print Driver** file, visit epson.com/support (U.S.), epson.ca/support (Canada), or latin.epson.com/support (Latin America) and select your product.
2. After downloading the installer file, double-click the downloaded file to install the software.

3. Follow the on-screen instructions until you see this screen:

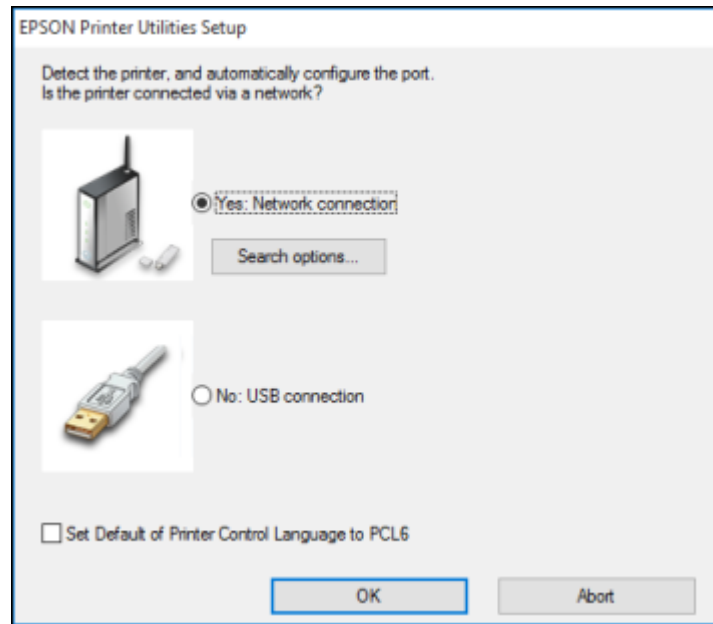

4. Select **Yes: Network connection** and click **OK**.

Note: Select the **Set Default of Printer Control Language to PCL6** checkbox if you want to set the default printer language to PCL6. Leave this option deselected to set the printer language to ESC/P-R. (You can change this setting later as needed.)

After the software finishes searching for products, you see a screen like this:

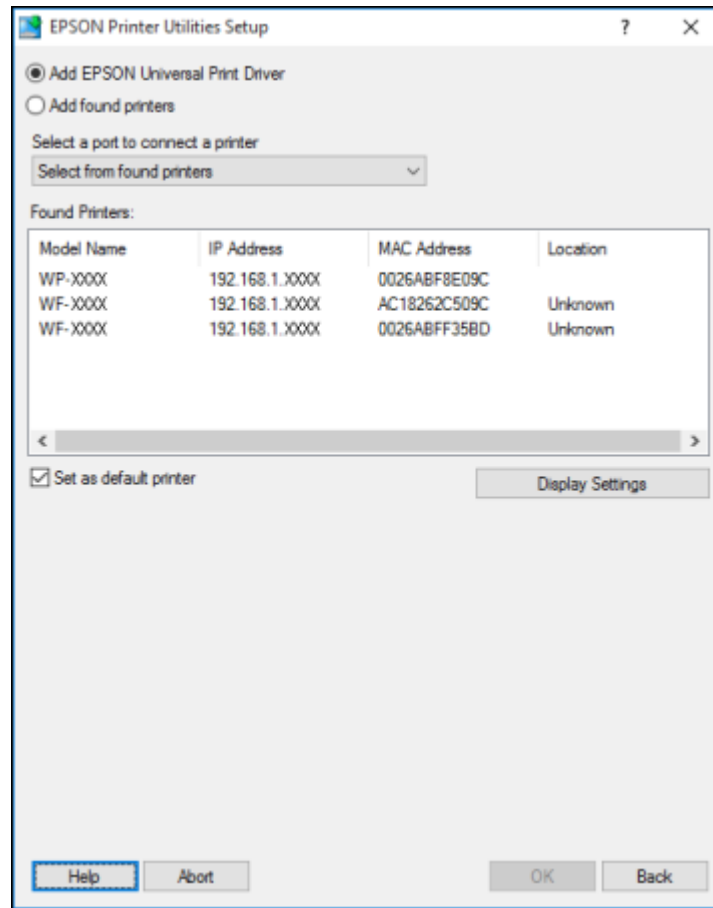

5. Do one of the following:
 - If you are installing one product, make sure **Add EPSON Universal Print Driver** is selected and continue with the next step.
 - If you are installing more than one product, select **Add found printers** and go to step 9.

Note: You can customize and filter your product search results by clicking **Display Settings**.

6. Open the **Select a port to connect a printer** menu and select an existing printer port, if necessary. Otherwise, skip this option to create a new port automatically.
7. Select the product you want to install from the Found Printers list.

Note: Deselect the **Set as default printer** checkbox if you do not want the product to be set as your default printer.

8. Click **OK**, then skip the remaining steps.
9. If you are installing more than one product, select the products from the Found Printers list and click **Add to Printer Folder**.

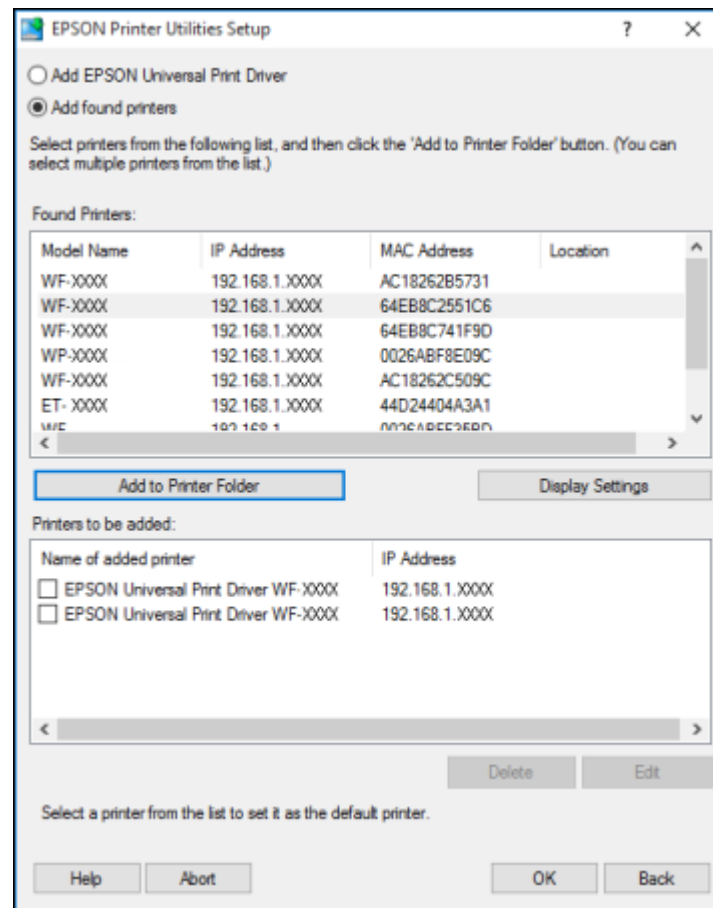

The selected products appear in the lower section of the screen.

10. Select the checkbox next to the product you want to make your default printer, if necessary.
11. Click **OK**.

Parent topic: [Enabling Epson Universal Print Driver \(PCL\) or PostScript Printing](#)

Installing the PostScript (PS3) Printer Software - Windows

If you did not install the standard Epson printer software or Epson Universal Print Driver, you need to install the PostScript (PS3) printer software before you can adjust the print settings and print to your network printer.

Note: Make sure your product is turned on and connected to the same network as your computer before installing the printer software.

1. To download the **Drivers and Utilities Combo Package - PS3 PostScript** file, visit epson.com/support (U.S.), epson.ca/support (Canada), or latin.epson.com/support (Latin America) and select your product.
2. After downloading the installer file, double-click the downloaded file to install the software.
3. Click **OK**.
4. Click **Accept**.
5. Click **Install**.
6. Click **Next** and follow the on-screen instructions.

Parent topic: [Enabling Epson Universal Print Driver \(PCL\) or PostScript Printing](#)

Installing the PostScript (PS3) Printer Software - Mac

If you did not install the standard Epson printer software, you need to install the PostScript (PS3) printer software before you can adjust the print settings and print to your network printer.

Note: Make sure your product is turned on and connected to the same network as your computer before installing the printer software.

1. To download the **Drivers and Utilities Combo Package - PS3 PostScript** file, visit epson.com/support (U.S.), epson.ca/support (Canada), or latin.epson.com/support (Latin America) and select your product.
2. After downloading the installer file, double-click the downloaded file to install the software.



3. Double-click **EPSON**.
4. Click **Continue** on the next two screens.
5. Click **Agree**.
6. Click **Install**.
7. If necessary, enter the administrator password.
8. Click **Start** and follow the on-screen instructions.

Parent topic: [Enabling Epson Universal Print Driver \(PCL\) or PostScript Printing](#)

Selecting PDL (Page Description Language) Settings

You can select settings for PCL and PostScript printing using the control panel on the product.

Note: These settings can be locked by an administrator. If you cannot access these settings, contact your administrator for assistance.

1. Press the  home button, if necessary.
2. Select **Settings > General Settings > Printer Settings > PDL Print Configuration**.
3. Select the PDL print configuration options you want to use from the available menus.
4. When you are finished, press the  home button to exit.

[PDL Print Configuration Options](#)

Parent topic: [Enabling Epson Universal Print Driver \(PCL\) or PostScript Printing](#)

PDL Print Configuration Options

Select the **PDL Print Configuration** options you want to use for PCL or PostScript printing.

PDL Print Configuration option	Available settings	Description
Common Settings		
Paper Size	Various sizes	Sets the default paper size for PCL or PostScript printing
Paper Type	Various paper types	Sets the default paper type for PCL or PostScript printing

PDL Print Configuration option	Available settings	Description
Orientation	Portrait	Sets the default orientation for PCL or PostScript printing
	Landscape	
Quality	Draft	Sets the quality for PCL or PostScript printing
	Standard	
Ink Save Mode	Off	Saves ink by reducing print density
	On	
Print Order	Last Page on Top	Starts printing from the first page of a file
	First Page on Top	Starts printing from the last page of a file
Number of Copies	1 to 999	Selects the number of copies to print
Binding Margin	Left Edge	Specifies the binding edge for double-sided documents
	Top Edge	
Auto Paper Ejection	Off	Ejects paper automatically when printing is stopped during a print job
	On	
2-Sided Printing	Off	Selects duplex printing
	On	
PCL Menu		
Font Source	Resident	Uses a font preinstalled on the printer
	Download	Uses a font you have downloaded
Font Number	0 to 65535	Selects the default font number for the default font source
Pitch	0.44 to 99.99 cpi	Selects the default font pitch if the font is scalable and fixed-pitch (availability depends on font source and number settings)
Height	4.00 to 999.75 pt	Selects the default font height if the font is scalable and proportional (availability depends on font source and number settings)

PDL Print Configuration option	Available settings	Description
Symbol Set	Various	Selects the default symbol set. If the selected font is not available for the selected symbol set, the font source and number are replaced with IBM-US (the default setting).
Form	5 to 128 lines	Sets the number of lines for the selected paper size and orientation. Changes the line spacing (VMI) stored in the printer. Later changes in page size or orientation cause changes in the Form value based on the stored VMI.
CR Function	CR	Selects the line feed command when printing with a driver from a specific operating system
	CR+LF	
LF Function	LF	
	CR+LF	
Paper Source Assign	4	Makes the paper source select command compatible with HP LaserJet 4
	4K	Makes the paper source select command compatible with HP LaserJet 4000, 5000, and 8000
	5S	Makes the paper source select command compatible with HP LaserJet 5S
PS Menu		
Error Sheet	Off	Prints a sheet showing the status when errors occur during PostScript or PDF printing
	On	
Coloration	Color	Selects the color mode for PostScript printing
	Mono	
Binary	Off	Enable when printing files that contain binary images (available when the product is connected to the network). Allows you to print binary images even if the driver is set to ASCII.
	On	



PDL Print Configuration option	Available settings	Description
PDF Page Size	Various sizes	Selects the paper size when printing a PDF file. If Auto is selected, the paper size is determined based on the size of the first page.

Parent topic: [Selecting PDL \(Page Description Language\) Settings](#)

Selecting Printer Language and Interface Settings

You can select printer language and interface settings using the control panel on the product.

Note: These settings can be locked by an administrator. If you cannot access these settings, contact your administrator for assistance.

1. Press the  home button, if necessary.
2. Select **Settings** > **General Settings** > **Printer Settings** > **Printing Language**.
3. Select the printing language and interface options for your connection type.
4. When you are finished, press the  home button to return to the Home screen.

[Printing Language and Interface Options](#)

Parent topic: [Enabling Epson Universal Print Driver \(PCL\) or PostScript Printing](#)

Printing Language and Interface Options

Select the printing language and interface options you want to use.

Main **Printer Settings** menu

Option	Available settings	Description
PC Connection via USB	Enable	Select whether to allow USB communication with the product
	Disable	

Option	Available settings	Description
USB I/F Timeout Setting	0, or 5 to 300 seconds	Specify the length of time before ending USB communication from a computer using the PCL or PostScript driver. This setting is necessary to avoid endless USB communication. If you do not want USB communication to timeout, enter 0.
Memory Device	Enable	Select whether to allow the product to access an inserted memory device. When disabled, the product can neither read or print data from the device, nor save data to the device.
	Disable	

Printing Language menu

Option	Available settings	Description
USB	Auto PCL PS PDF ESC/Page	Select the language for the USB or network interface
Network		
Additional Network (only available with the optional LAN interface)		

Parent topic: [Selecting Printer Language and Interface Settings](#)

Printing a PCL or PS3 (PostScript) Status Sheet

You can print a PCL or PS3 (PostScript) status sheet to confirm the current font information.

1. Press the  home button, if necessary.
2. Select **Settings** > **Printer Status/Print** > **Print Status Sheet**.
3. Select **PS Font List** or **PCL Font List**.
4. Select **Print** to print the status sheet.

Parent topic: [Enabling Epson Universal Print Driver \(PCL\) or PostScript Printing](#)

Loading Paper

Before you print, load paper for the type of printing you will do.

Note: Load only plain paper when printing with the PCL or PostScript (PS3) printer software.

[Loading Paper in the Cassettes and Paper Tray](#)

[Using the Optional Paper Cassette Lock](#)

[Paper Loading Capacity](#)

[Double-sided Printing](#)

[Compatible Epson Papers \(U.S. and Canada\)](#)

[Compatible Epson Papers \(Latin America\)](#)

[Paper or Media Type Settings - Printing Software](#)

[Selecting the Paper Settings for Each Source - Control Panel](#)



[Selecting Default Paper Settings - Administrator](#)

Loading Paper in the Cassettes and Paper Tray

You can load paper up to 11 × 17 inches (279 × 432 mm) or A3 (11.7 × 16.5 inches [297 × 420 mm]) in the paper cassettes and 12 × 18 inches (305 × 457 mm) in the paper tray. The paper tray can accommodate user-defined paper sizes from 2.2 × 5.5 inches (55 × 140 mm) to 11.7 × 47.2 inches (297 × 1200 mm) for single-sided printing. The paper tray can accommodate user-defined paper sizes from 5.5 × 7.2 inches (139.7 × 182 mm) to 11.7 × 17 inches (297 × 431.8 mm) for double-sided printing.

You can view instructions on how to load paper in the cassettes or paper tray on the control panel.

Note: If you cannot smoothly open or close the paper tray, make sure to hold the center of the paper tray when extending or retracting it.

1. Select the  icon on the LCD screen.
2. Select **How to > Load paper**.
3. Select one of the options.
4. Select **How To**.
5. Select the  icon to scroll through the paper loading instructions.

6. If necessary, select **Close** and then select the  icon and select the size and type of paper you loaded on the LCD screen.

Note: If the **Paper Size Auto Detect** setting is enabled, your product will automatically detect the size of the paper you loaded. To select a user-defined paper size, disable the **Paper Size Auto Detect** setting.

Always follow these paper loading guidelines:

- Load only the recommended number of sheets.
- Load the printable side face up.
- Load letterhead or pre-printed paper top edge first.
- Do not load paper above the arrow mark inside the edge guides.
- Insert and remove paper cassettes slowly.
- Load pre-punched paper with the punched side toward you. Loading pre-punched paper in an incorrect direction can cause paper jams or smears inside the product. Make sure the **Prepunched** setting is set to **On** in the product's paper settings.
- Check the paper package for any additional loading instructions.

Caution: Do not use the following papers; they may cause paper jams, smears on the printout, or damage to the printer.

- Papers that are wavy or damp
- Papers that have not dried after printing on one side
- Papers that are wadded or curled
- Papers that are torn, cut, or folded
- Papers that are too thick or thin
- Preprinted papers printed by other inkjet printers, thermal transfer printers, page printers, or copiers
- Papers that are perforated
- Papers that have stickers
- Papers held together with tape, staples, or paper clips
- Envelopes with adhesive surfaces or windows

[Paper Loading Orientation](#)

Parent topic: [Loading Paper](#)

Paper Loading Orientation

When loading non-standard papers into the product, use the following guidelines:

Envelopes

- **Paper tray:** Load envelopes into the paper tray with the short edge first and the printable side facing down. Align the edge guides with the edges of the envelopes. You can load up to 10 envelopes at once.

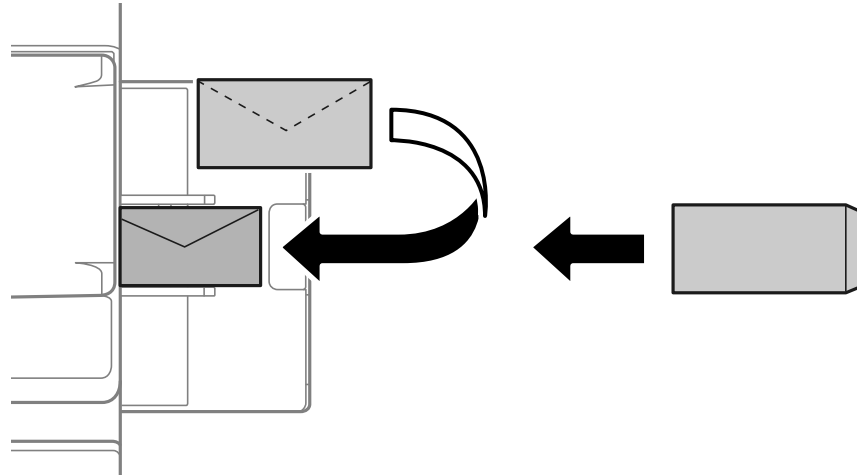

- **Paper cassette:** Load envelopes into the paper cassette with the printable side facing up. Align the edge guides with the edges of the envelopes. You can load up to 30 envelopes at once.

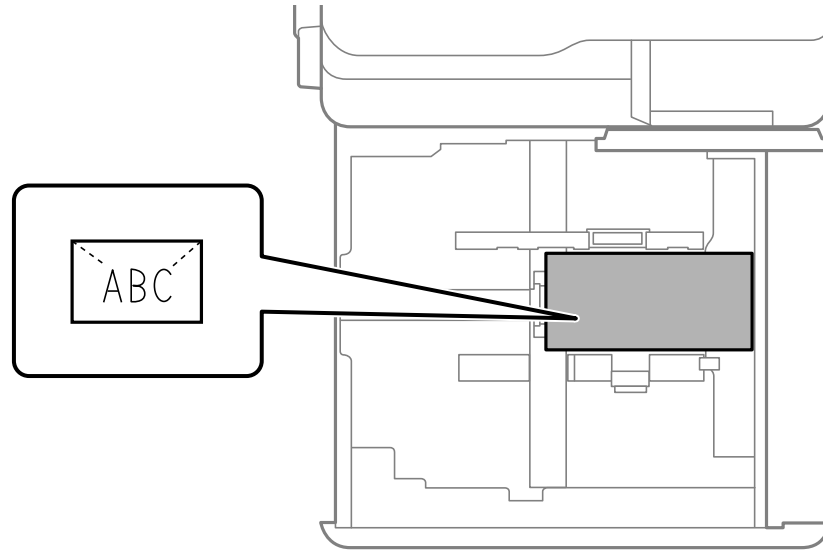

Pre-punched paper

Set your margins so you do not print over the holes in the paper. You cannot print in the area 0.67 inches (17 mm) from the pre-punched edge of the paper.

Note: Make sure you enable the **Prepunched** setting on the paper settings screen on the control panel. You may have to select the  icon to display the settings screen.

- **Paper tray:** Load pre-punched paper into the paper tray with the holes facing the front of the product and the printable side facing down. Align the edge guides with the edges of the envelopes.

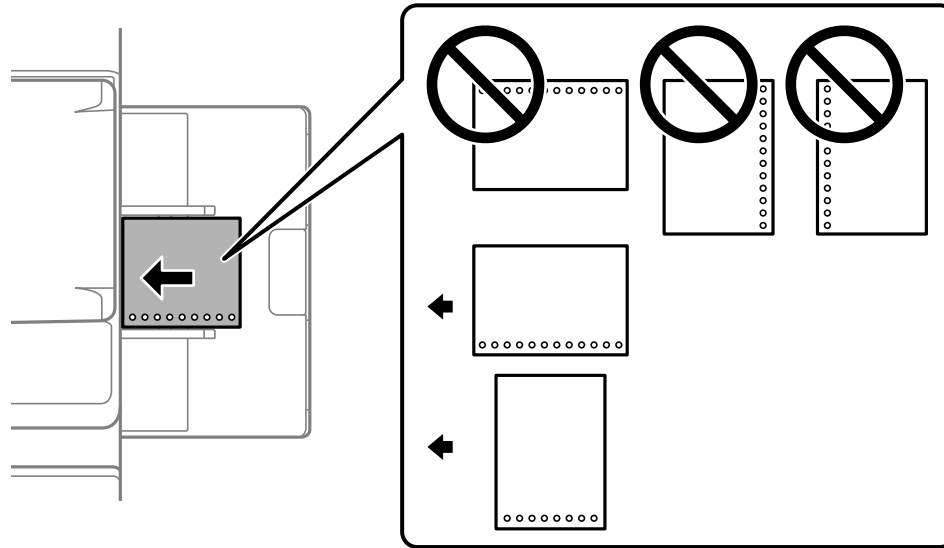

- **Paper cassette:** Load pre-punched paper into the paper tray with the holes facing the front of the product and the printable side facing up.

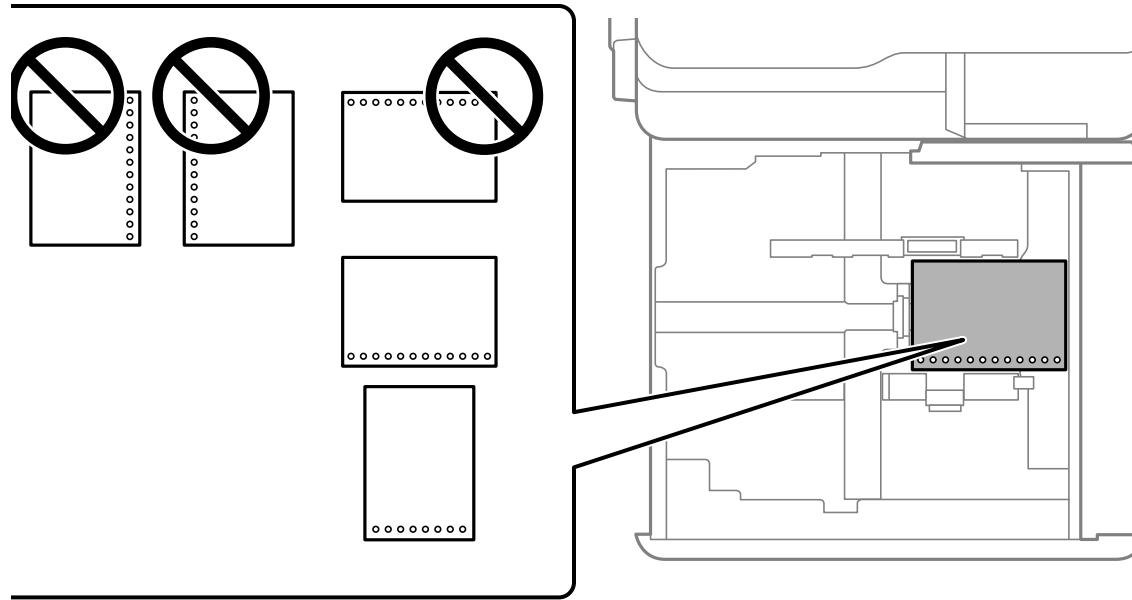

Pre-printed paper (single-sided printing)

Note: Make sure you enable the **Preprinted** setting on the paper settings screen on the control panel. You may have to select the  icon to display the settings screen.

- **Paper tray:** When printing on only one side of the paper, load pre-printed paper into the paper tray with the printable side facing down. Align the edge guides with the edges of the paper.

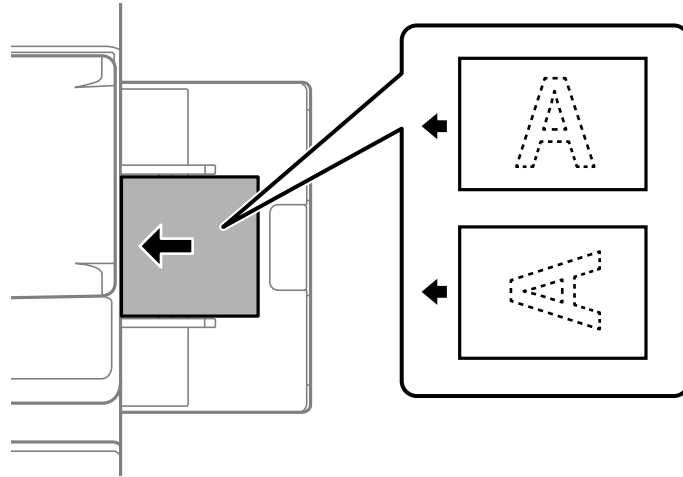

- **Paper cassette:** When printing on only one side of the paper, load pre-printed paper into the paper cassette with the printable side facing up. Align the edge guides with the edges of the paper.

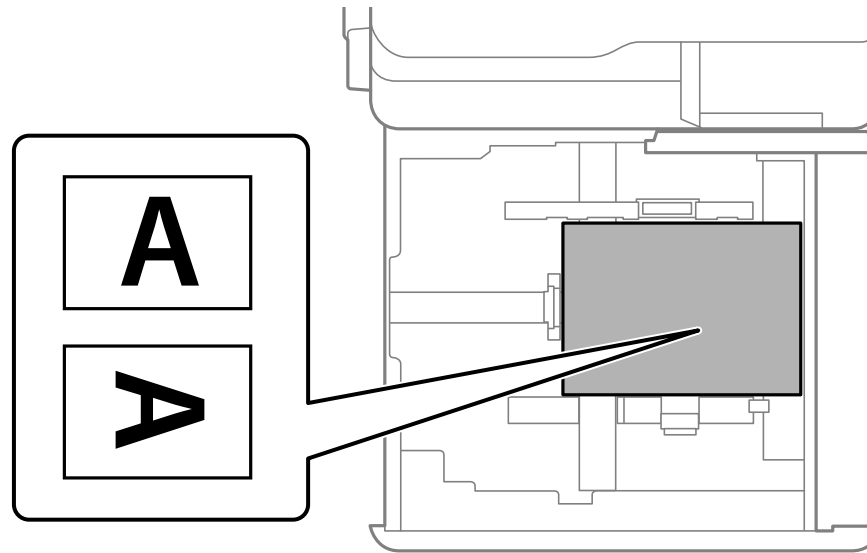

Pre-printed paper (double-sided printing)

- **Paper tray:** When printing on both sides of pre-printed paper, load the paper into the paper tray with the first page to be printed facing up. Align the edge guides with the edges of the paper.

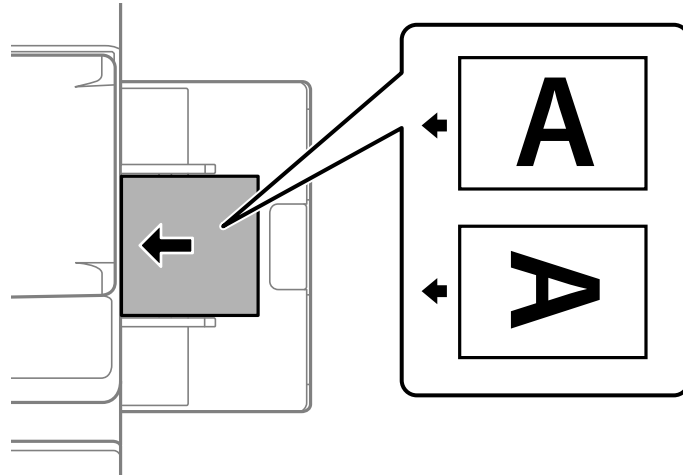

- **Paper cassette:** When printing on both sides of pre-printed paper, load the paper into the paper cassette with the first page to be printed facing down. Align the edge guides with the edges of the paper.

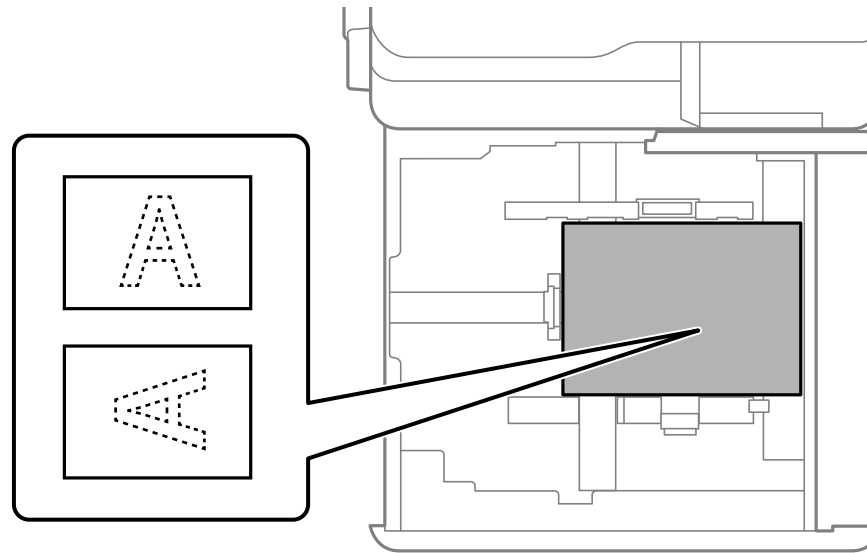

Long paper

When loading long paper, load a single sheet in the paper tray. Set the **Paper Size Auto Detect** setting to **Off** and select **User-Defined** as the paper size.

- If paper falls from the face-down tray, prepare a box or similar receptacle to make sure the paper does not touch the floor.
- Do not touch the paper as it is being ejected. This could injure your hand or cause print quality to decline.

- When loading long paper, be careful not to cut your hands on the edges of the paper while holding it.

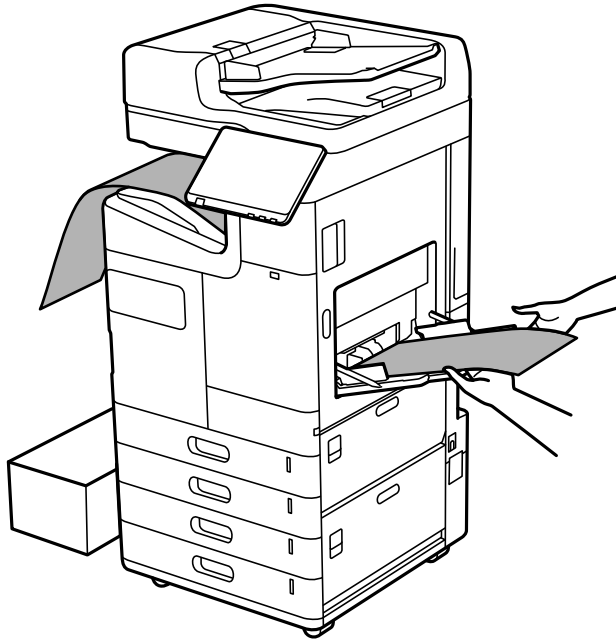

Parent topic: [Loading Paper in the Cassettes and Paper Tray](#)

Using the Optional Paper Cassette Lock

You can use the optional paper cassette lock to keep the paper cassettes locked. You will need a padlock that can fit through the hole in the paper cassette lock. Make sure you keep the key in a safe place.

Note: If you also want to lock the optional dual cassette, you will need a second paper cassette lock and padlock.

You can purchase genuine Epson accessories at epson.com (U.S. sales) or epson.ca (Canadian sales). You can also purchase accessories from an Epson authorized reseller. To find the nearest one, call 800-GO-EPSON (800-463-7766) in the U.S. or 800-807-7766 in Canada.

1. Remove the seals from the paper cassettes.

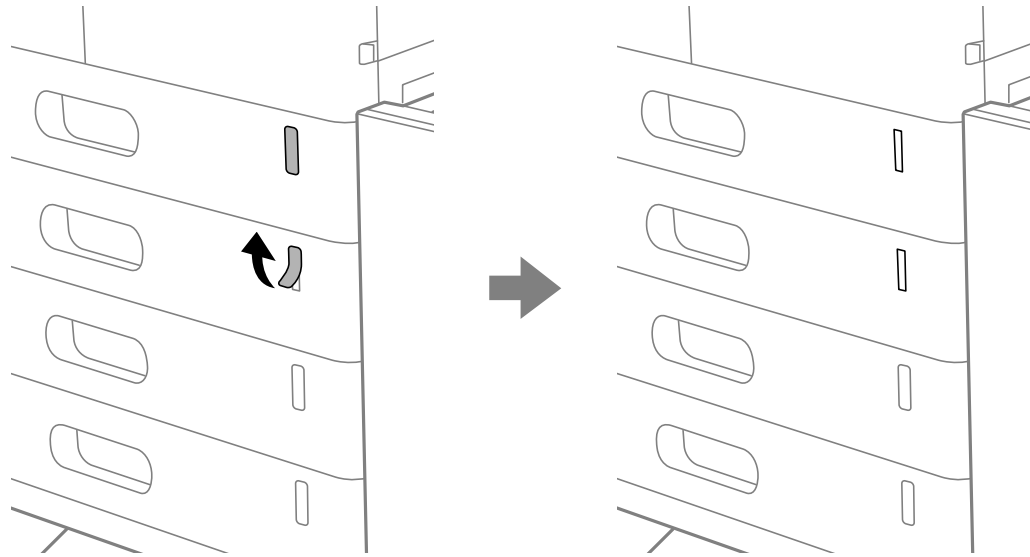

2. Insert the paper cassette lock into the slots.

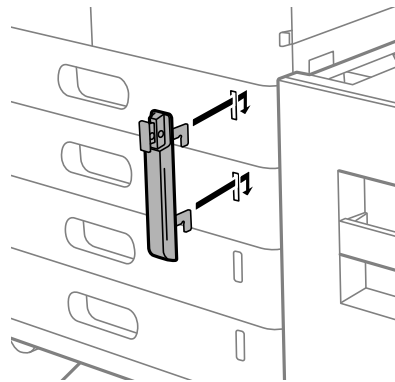

3. Press the latch on top of the paper cassette lock and align the holes.

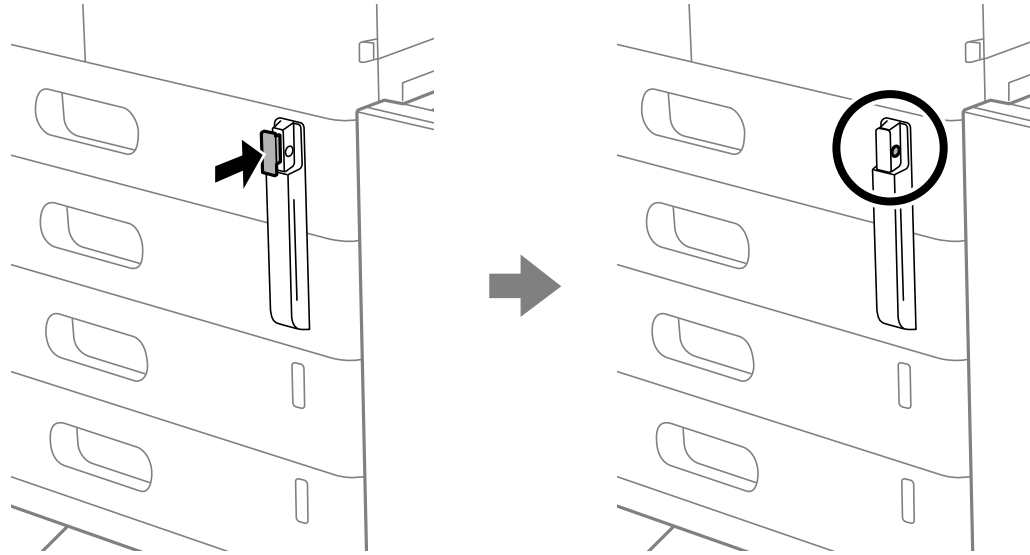

Note: To unlock the paper cassette, insert the key all the way into the lock and pull out the lock.

4. Insert the padlock through the holes and lock it.

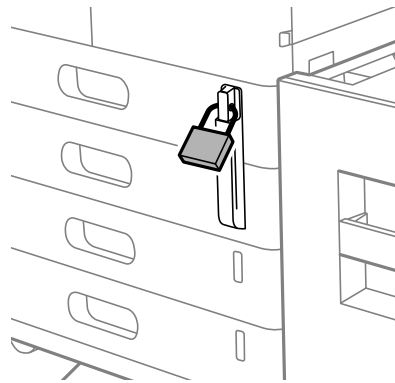

Parent topic: [Loading Paper](#)

Related references

[Optional Accessories and Replacement Parts](#)

Paper Loading Capacity

Paper Cassettes

The table below shows the paper cassette capacity for paper in the following sizes unless noted otherwise:

- Letter (8.5 × 11 inches [216 × 279 mm]), Half Letter (5.5 × 8.5 inches [140 × 216 mm]), Legal (8.5 × 14 inches [216 × 356 mm]), Executive (7.25 × 10.5 inches [184 × 267 mm])
- A6 (4.1 × 5.8 inches [105 × 148 mm]), A5 (5.8 × 8.2 inches [148 × 210 mm]), A4 (8.3 × 11.7 inches [210 × 297 mm]), A3 (11.7 × 16.5 inches [297 × 420 mm])
- B6 (5 × 7.2 inches [128 × 182 mm]), B5 (7.2 × 10.1 inches [182 × 257 mm]), B4 (13.9 × 9.84 inches [353 × 250 mm])
- Oficio 9 (8.46 × 12.4 inches [215 × 315 mm]), Mexico-Oficio (8.5 × 13.4 inches [216 × 340 mm])
- 8.5 × 13 inches (216 × 330 mm), 11 × 17 inches (279 × 432 mm)
- User-defined (3.3 × 5.5 inches to 11.7 × 17 inches [85 × 140 mm to 297 × 431.8 mm])

Paper type	Loading capacity
Plain paper Pre-printed paper Letterhead paper Colored paper Recycled paper High quality plain paper	Up to the line indicated by the triangle symbol on the edge guide (500 sheets)
Card Stock 1 (25 to 28 lb [91 to 105 g/m ²])	Up to the line indicated by the triangle symbol on the edge guide (400 sheets)
Card Stock 2 (29 to 36 lb [106 to 135 g/m ²])	Up to the line indicated by the triangle symbol on the edge guide (350 sheets)
Card Stock 3 (37 to 42 lb [136 to 160 g/m ²])	Up to the line indicated by the triangle symbol on the edge guide (200 sheets)

Paper type	Loading capacity
Card Stock 4 (43 to 66 lb [161 to 250 g/m ²]) Extra Thick Paper (67 to 80 lb [251 to 300 g/m ²])	125 sheets
Epson Bright White Premium Paper Epson Multipurpose Plus Paper	500 sheets: Letter (8.5 × 11 inches [216 × 279 mm])
Epson Bright White Pro Paper	500 sheets: A3 (11.7 × 16.5 inches [297 × 420 mm]) Letter (8.5 × 11 inches [216 × 279 mm])
Envelopes	30

Paper Tray

The table below shows the paper tray capacity for paper in the following sizes unless noted otherwise.

Note: For paper longer than 17 inches (432.1 mm), load one sheet at a time.

- Letter (8.5 × 11 inches [216 × 279 mm]), Half Letter (5.5 × 8.5 inches [140 × 216 mm]), Legal (8.5 × 14 inches [216 × 356 mm]), Executive (7.25 × 10.5 inches [184 × 267 mm])
- A6 (4.1 × 5.8 inches [105 × 148 mm]), A5 (5.8 × 8.2 inches [148 × 210 mm]), A4 (8.3 × 11.7 inches [210 × 297 mm]), A3 (11.7 × 16.5 inches [297 × 420 mm])
- B6 (5 × 7.2 inches [128 × 182 mm]), B5 (7.2 × 10.1 inches [182 × 257 mm]), B4 (13.9 × 9.84 inches [353 × 250 mm])
- Oficio 9 (8.46 × 12.4 inches [215 × 315 mm]), Mexico-Oficio (8.5 × 13.4 inches [216 × 340 mm])
- 8.5 × 13 inches (216 × 330 mm), 11 × 17 inches (279 × 432 mm) 12 × 18 inches (305 × 457 mm)
- User-defined (2.2 × 5.5 inches to 11.7 × 47.2 inches [55 × 140 mm to 297 × 1200 mm])

Paper type	Loading capacity
Plain paper Pre-printed paper Letterhead paper Colored paper Recycled paper	Up to the line indicated by the triangle symbol on the edge guide (150 sheets)
Card Stock 1 (25 to 28 lb [91 to 105 g/m ²])	Up to the line indicated by the triangle symbol on the edge guide (120 sheets)
Card Stock 2 (29 to 36 lb [106 to 135 g/m ²])	Up to the line indicated by the triangle symbol on the edge guide (100 sheets)
Card Stock 3 (37 to 42 lb [136 to 160 g/m ²])	Up to the line indicated by the triangle symbol on the edge guide (80 sheets)
Card Stock 4 (43 to 66 lb [161 to 250 g/m ²])	Up to the line indicated by the triangle symbol on the edge guide (50 sheets)
Extra Thick Paper (67 to 80 lb [251 to 300 g/m ²])	Up to the line indicated by the triangle symbol on the edge guide (40 sheets)
Epson Bright White Premium Paper Epson Multipurpose Plus Paper	150 sheets: Letter (8.5 × 11 inches [216 × 279 mm])
Epson Bright White Pro Paper	150 sheets: A3 (11.7 × 16.5 inches [297 × 420 mm]) Letter (8.5 × 11 inches [216 × 279 mm])
Epson Ultra Premium Presentation Paper Matte	20 sheets: Letter (8.5 × 11 inches [216 × 279 mm]) A4 (8.3 × 11.7 inches [210 × 297 mm]) A3 (11.7 × 16.5 inches [297 × 420 mm]) 13 × 19 inches (330 × 483 mm)

Paper type	Loading capacity
Epson Premium Presentation Paper Matte	20 sheets: A4 (8.3 × 11.7 inches [210 × 297 mm]) A3 (11.7 × 16.5 inches [297 × 420 mm]) Letter (8.5 × 11 inches [216 × 279 mm]) 8 × 10 inches (203 × 254 mm)
Epson High Quality Ink Jet Paper Epson Presentation Paper Matte	50 sheets: A3 (11.7 × 16.5 inches [297 × 420 mm]) 100 sheets: Letter (8.5 × 11 inches [216 × 279 mm]) A4 (8.3 × 11.7 inches [210 × 297 mm])
Envelopes	10

Parent topic: [Loading Paper](#)

Double-sided Printing

You can print double-sided on the following papers:

- Plain paper
- Pre-printed paper
- Letterhead paper
- Colored paper
- Recycled paper
- High quality plain paper
- Thick paper (up to 66 lb ([250 g/m²])
- Epson Bright White Pro Paper
- Epson Bright White Premium Paper
- Epson Multipurpose Plus Paper
- Epson Premium Presentation Paper Matte Double-sided

Note: You can print double-sided on any supported sizes except the following:

- B6 (5 × 7.2 inches [128 × 182 mm])
- A6 (4.1 × 5.8 inches [105 × 148 mm])
- 12 × 18 inches (305 × 457 mm)

To print double-sided with a user-defined size, the dimensions of the paper must have a width between 5.5 and 7.4 inches (139.7 to 189 mm) and a length between 11.6 and 17 inches (297 to 431.8 mm).

Parent topic: [Loading Paper](#)

Compatible Epson Papers (U.S. and Canada)

You can purchase genuine Epson ink and paper at epson.com (U.S. sales) or epson.ca (Canadian sales). You can also purchase supplies from an Epson authorized reseller. To find the nearest one, call 800-GO-EPSON (800-463-7766) in the U.S. or 800-807-7766 in Canada.

Paper Type	Size	Part number	Sheet count
Epson Bright White Pro Paper	Letter (8.5 × 11 inches [216 × 279 mm])	S041586	500
Epson Bright White Premium Paper	Letter (8.5 × 11 inches [216 × 279 mm])	S450218-4	500
Epson Multipurpose Plus Paper	Letter (8.5 × 11 inches [216 × 279 mm])	S450217-4	500
Epson High Quality Ink Jet Paper	Letter (8.5 × 11 inches [216 × 279 mm])	S041111	100
	A4 (8.3 × 11.7 inches [210 × 297 mm])	S041117	100
Epson Presentation Paper Matte	Letter (8.5 × 11 inches [216 × 279 mm])	S041062	100
Epson Premium Presentation Paper Matte	8 × 10 inches (203 × 254 mm)	S041467	50
	Letter (8.5 × 11 inches [216 × 279 mm])	S041257	50
		S042180	100
	A3 (11.7 × 16.5 inches [297 × 420 mm])	S041260	50

Paper Type	Size	Part number	Sheet count
Epson Premium Presentation Paper Matte Double-sided	Letter (8.5 × 11 inches [216 × 279 mm])	S041568	50
Epson Ultra Premium Presentation Paper Matte	Letter (8.5 × 11 inches [216 × 279 mm])	S041341	50
	A3 (11.7 × 16.5 inches [297 × 420 mm])	S041914	250
	A3 (11.7 × 16.5 inches [297 × 420 mm])	S041343	50

Parent topic: [Loading Paper](#)

Compatible Epson Papers (Latin America)

You can purchase genuine Epson ink and paper from an Epson authorized reseller. To find the nearest reseller, visit latin.epson.com or call your nearest Epson sales office.

Paper Type	Size	Part number	Sheet count
Epson Bright White Pro Paper	Letter (8.5 × 11 inches [216 × 279 mm])	S041586	500
Epson High Quality Ink Jet Paper	Letter (8.5 × 11 inches [216 × 279 mm])	S041111	100
	A4 (8.3 × 11.7 inches [210 × 297 mm])	S041117	100
Epson Presentation Paper Matte	13 × 19 inches (330 × 483 mm)	S041069-L	100
Epson Premium Presentation Paper Matte	Letter (8.5 × 11 inches [216 × 279 mm])	S041257-ML	50
	13 × 19 inches (330 × 483 mm)	S041263	50
	A3 (11.7 × 16.5 inches [297 × 420 mm])	S041260	50
Epson Ultra Premium Presentation Paper Matte	13 × 19 inches (330 × 483 mm)	S041339	50
		S041605	100

Parent topic: [Loading Paper](#)

Paper or Media Type Settings - Printing Software



For this paper	Select this paper Type or Media Type setting
Plain paper (16 to 20 lb [60 to 75 g/m ²]) Epson Bright White Pro Paper Epson Bright White Premium Paper Epson Multipurpose Plus Paper	Plain Paper 1
Plain paper (20 to 24 lb [76 to 90 g/m ²])	Plain Paper 2
Letterhead paper	Letterhead
Recycled paper	Recycled
Colored paper	Color
Pre-printed paper	Preprinted
Epson High Quality Ink Jet Paper	High quality plain paper
Thin paper (14 to 16 lb [52 to 59 g/m ²])	Thin paper
Thick paper (25 to 28 lb [91 to 105 g/m ²])	Card Stock 1
Thick paper (29 to 36 lb [106 to 135 g/m ²])	Card Stock 2
Thick paper (37 to 42 lb [136 to 160 g/m ²])	Card Stock 3
Thick paper (43 to 66 lb [161 to 250 g/m ²])	Card Stock 4
Envelopes	Envelope
Epson Presentation Paper Matte Epson Premium Presentation Paper Matte Epson Ultra Premium Presentation Paper Matte	Epson Matte

Note: The settings listed here are available only when printing from your computer; they do not apply to your product's control panel settings.

Parent topic: [Loading Paper](#)

Selecting the Paper Settings for Each Source - Control Panel

You can change the default paper size and paper type for each source using the control panel on the product.

1. Select the  icon.
2. Select the paper source you want to select settings for.
3. Select **Paper Size**.
4. Select the paper size you loaded.
5. Select **Paper Type**.
6. Select the paper type for the paper you loaded.
7. Enable the **Prepunched** setting if you are using pre-punched paper.
8. To automatically detect the size of paper loaded in the paper source, select the **Paper Size Auto Detect** field to turn this setting on.
9. Select **Close**.
10. Select another paper source to change or press the  home button to exit.

[Paper Type Settings - Control Panel](#)

Parent topic: [Loading Paper](#)

Paper Type Settings - Control Panel

Select a **Paper Type** setting that matches the paper you loaded.

Paper type loaded	Paper Type setting
Plain paper	Plain Paper 1 (60-75g/m2)
Epson Bright White Pro Paper	Plain Paper 2 (76-90g/m2)
Epson Bright White Premium Paper	
Epson Multipurpose Plus Paper	
Letterhead paper	Letterhead
Recycled paper	Recycled
Colored paper	Color
Pre-printed paper	Preprinted

Paper type loaded	Paper Type setting
Epson High Quality Ink Jet Paper	High Quality Plain Paper
Thick paper up to 25 to 28 lb (91 to 105 g/m ²)	Card Stock 1 (91-105g/m ²)
Thick paper up to 29 to 36 lb (106 to 135 g/m ²)	Card Stock 2 (106-135g/m ²)
Thick paper up to 37 to 42 lb (136 to 160 g/m ²)	Card Stock 3 (136-160g/m ²)
Thick paper up to 43 to 66 lb (161 to 250 g/m ²)	Card Stock 4 (161-250g/m ²)
Thick paper up to 67 to 90 lb (251 to 350 g/m ²)	Extra Thick Paper
Envelopes	Envelope
Epson Presentation Paper Matte Epson Premium Presentation Paper Matte Epson Ultra Premium Presentation Paper Matte	Matte
Epson Premium Presentation Paper Matte Double-sided	Double-Sided Photo Quality Inkjet

Parent topic: [Selecting the Paper Settings for Each Source - Control Panel](#)

Selecting Default Paper Settings - Administrator

As an administrator, you can adjust default paper settings that apply to all print jobs sent to the product.

Note: These settings can be locked by an administrator. If you cannot access these settings, contact your administrator for assistance.

[Selecting the Default Printer Settings](#)



[Selecting the Universal Print Settings](#)

Parent topic: [Loading Paper](#)

Selecting the Default Printer Settings

You can change default printer settings using the control panel on the product.

Note: These settings can be locked by an administrator. If you cannot access these settings, contact your administrator for assistance.

1. Press the  home button, if necessary.
2. Select **Settings > General Settings > Printer Settings**.
3. Select an **Auto Error Solver** setting:
 - Select **On** to display a warning and print single-sided when a 2-sided printing error occurs, or to print only what the printer could process when a full memory error occurs.
 - Select **Off** to display an error message and stop printing if an error occurs.
4. Select **Paper Source Settings**.
5. Select the options you want to use.
6. When you are finished, press the  home button to exit.

[Paper Source Settings Options](#)

Parent topic: [Selecting Default Paper Settings - Administrator](#)

Paper Source Settings Options

Select the paper source options you want to use for your print jobs.

Paper Source Settings option	Available settings	Description
Paper Setting	Various	Select the paper size and type for each paper source.
Paper Tray Priority	On	Select On to give printing priority to paper loaded in the paper tray.
	Off	
A4/Letter Auto Switching	On	Select On to switch the selected paper size to match the loaded paper (Letter or A4) if the wrong size is selected.
	Off	
Auto Select Settings	Copy	Select On for any of these settings to automatically print on paper from any source containing paper that matches your paper settings.
	Fax	
	Other	
Automatic Selection at Paper Out: For Copy/Storage Printing	On	Select On to feed paper automatically from another source with the same paper settings when copying or printing from storage. The alternate source must be enabled in the Auto Select Settings setting.
	Off	



Paper Source Settings option	Available settings	Description
Error Notice	Paper Size Notice	Select On for either of these settings to display an error message when the selected paper type or size does not match the loaded paper.
	Paper Type Notice	
Paper Setup Auto Display	On	Select On to automatically display a menu that lets you select the paper size and type when you load paper in the product. Note: If this setting is disabled, you cannot print using AirPrint.
	Off	
User-Defined Paper Size List	20 settings	Enter a user-defined paper size setting.

Parent topic: [Selecting the Default Printer Settings](#)

Selecting the Universal Print Settings

You can change the default universal print settings using the control panel on the product.

Note: These settings can be locked by an administrator. If you cannot access these settings, contact your administrator for assistance.

1. Press the  home button, if necessary.
2. Select **Settings > General Settings > Printer Settings > Universal Print Settings**.
3. Adjust the settings as necessary.
4. When you are finished, press the  home button to exit.

[Universal Print Settings Options](#)

Parent topic: [Selecting Default Paper Settings - Administrator](#)

Universal Print Settings Options

Select the universal print setting options you want to use for your print jobs.

Universal Print Settings option	Available settings	Description
Top Offset	—	Adjust the top or left margin.
Left Offset		
Top Offset in Back	—	Adjust the top or left margin of the back page when printing double-sided.
Left Offset in Back		
Skip Blank Page	On	Select On to skip printing of blank pages automatically.
	Off	
Job Separation	On	Select On to separate printed copies by job.
	Off	
Rotate Sort	On	Select On to rotate each copy when printing multiple copies.
	Off	
Insert Sheets per User	On	Select On to insert a blank sheet between copies or print jobs sent to the printer from the printer driver. Select the paper source you want the sheets to come from.
	Off	
Color Correction	On	Select On to adjust settings such as brightness, contrast, saturation, and more.
	Off	

Parent topic: [Selecting the Universal Print Settings](#)

Placing Originals on the Product

Follow the instructions here to place your original documents or photos on the product.

Caution: Do not place anything on top of your product or use its cover as a writing surface to avoid damaging it.

[Placing Originals on the Scanner Glass](#)

[Placing Originals in the Automatic Document Feeder](#)

Placing Originals on the Scanner Glass

You can place originals up to this size on the scanner glass: A3 (11.7 × 16.5 inches [297 × 420 mm]) or 11 × 17 inches (279 × 432 mm).

Note: When originals are placed in the ADF and on the scanner glass, priority is given to the originals in the ADF.

1. Press the  help button and select **How To > Place Originals > Scanner Glass**.
2. Follow the onscreen instructions.

Caution: Be careful not to trap your hands or fingers when opening or closing the document cover. Do not push down on the document cover or scanner glass or you may damage the product.

Note: If there is any dust or dirt on the scanner glass, the scanning range may expand to include it, so the image of the original may be displaced or reduced. Use a soft, dry, clean cloth to remove any dust and dirt on the scanner glass before scanning. When placing bulky originals such as books, prevent exterior light from shining directly onto the scanner glass.

Note: The edges of your original may be cropped by 0.06 inch (1.5 mm) from the edge of the scanner glass. Manually position your original away from the edges to prevent cropping.

Remove your originals after scanning. If you leave the originals on the scanner glass for a long time, they may stick to the glass surface.

Parent topic: [Placing Originals on the Product](#)

Placing Originals in the Automatic Document Feeder

You can place single- or multi-page original documents in the Automatic Document Feeder (ADF). You can also use the ADF to scan both sides of a 2-sided document. Make sure the originals meet the Automatic Document Feeder specifications before loading them.

Caution: Do not load the following types of originals in the ADF, or they may be damaged or may damage the scanner. Use the scanner glass for these types:

- Ripped, curled, folded, deteriorated, or wrinkled originals
- Originals with holes
- Originals containing staples or paper clips
- Originals with carbon paper backing
- Originals with labels, stickers, or sticky notes
- Originals that are bound
- Originals that are cut irregularly or not cut at a right angle
- Photos or valuable artwork
- Thermal paper
- Transparencies
- Fabric or other non-paper originals
- Originals with uneven surfaces, such as embossed documents
- Originals with wet ink

Note: When originals are placed in the ADF and on the scanner glass, priority is given to the originals in the ADF.

Note: Do not load originals above the line under the triangle symbol on the ADF edge guide. Do not load originals while scanning.

1. Select the  icon and select **How To > Place Originals > ADF**.
2. Follow the on-screen instructions.

Parent topic: [Placing Originals on the Product](#)

Copying

See the information here to copy documents or photos using your product.

Note: Copies may not be exactly the same size as your originals.

[Copying Documents or Photos](#)

[Copying Special Originals](#)

[Copying, Sorting, and Creating Booklets](#)

[Copying Options](#)

[Saving Groups for Copying](#)

[Editing or Deleting a Saved Group for Copying](#)

[Omitting Red Characters in Originals When Copying](#)

Copying Documents or Photos

You can copy documents or photos onto various sizes and types of paper, including Epson special papers.

1. Load the paper you want to print on.
2. Place your original document or photo on the scanner glass, or place multi-page documents in the ADF.
3. Press the  home button, if necessary.
4. Select **Copy**.
5. To print more than one copy, select **Copies** and use the on-screen keyboard to enter the number of copies.

Note: If you want to print copies using a saved group, select **Advanced** and then select **Print Sets**. Select the group you want to use and select **OK**. The **Print Sets** feature requires a registered license key.

6. Change any of the displayed settings as necessary.
 - To create double-sided copies of your originals, select **2-sided** and select either **1>2-sided** or **2>2-sided**.
 - To enlarge or reduce your original, select **Reduce/Enlarge** and select settings as necessary.

- To copy multiple originals onto a single sheet, select **Multi-Page > 2-up** or **4-up**, then specify the layout order and the orientation of the original.
 - To output your originals in page order, select **Finishing > Collate (Page Order)**.
7. Select **Advanced** to view and change additional copy settings, if necessary. If you would like to remove shadows or punch holes from your copies, enable the **Remove Shadow** or **Remove Punch Holes** settings.

Note: To save the copied image to the product's internal storage, select **File Storing** and enable the **File Storing** setting. Change any of the displayed settings as needed.

Note: If there is an image at the hole punch position, select **Binding Margin** and set a binding margin of 0.71 inch (18 mm) before copying. If you set a binding margin, you can select **Binding Width, Reduce to Fit Paper, or Erase Image Over Margin** to adjust your image accordingly.

8. Select **Preview** to preview your copy on the LCD screen.

Note: If you are printing multiple copies, you can enable the **Proof Copy** setting from the Advanced tab to print one copy for confirmation before printing the rest.

9. Select the  icon to save your copy settings.

Note: Presets can be locked by an administrator. If you can't access or change this setting, contact your administrator for assistance.

10. When you are ready to copy, select the **Copy** icon.

Note: To cancel printing, select **Cancel** on the LCD screen, then select **Cancel Copy** to confirm.

Parent topic: [Copying](#)

Copying Special Originals

You can copy various originals, such as an ID card, book, or envelope using the scanner glass.

1. Place your original on the scanner glass.
2. Press the  home button, if necessary.
3. Select **Copy**.

4. Depending on the type of original, do one of the following:

- To copy both sides of an ID card, select **Advanced > ID Card Copy**. Specify the orientation of the card.

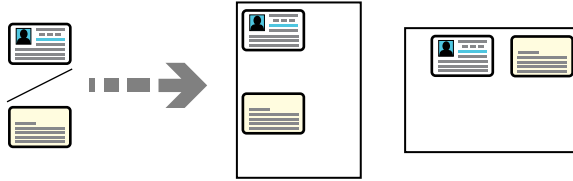

- To scan two facing pages of a book, select **Advanced > Book>2Pages**. Enable the setting and specify the scan order.

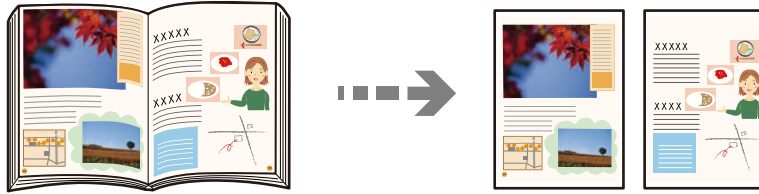

- To copy an envelope, place the envelope on the scanner glass as shown, and make sure you have envelopes loaded in the correct orientation.

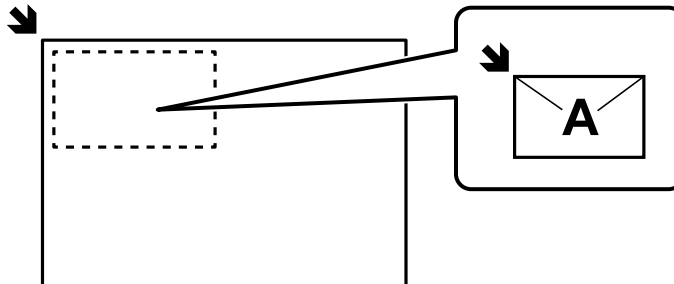

5. To print more than one copy, select **Copies** and use the displayed numeric keypad to select the number of copies.
6. Change any of the displayed settings as necessary.

7. When you are ready to copy, select the  icon.

Note: To cancel printing, select **Cancel** on the LCD screen, then select **Cancel Copy** to confirm.

8. If you are copying an ID card, follow the on-screen instructions to copy the back of the ID.

Parent topic: [Copying](#)

Copying, Sorting, and Creating Booklets

See the information here to sort and assemble documents into booklets using your product's finishing options.

Note: Some finishing options require optional equipment that may or may not be installed with your product.

[Copying and Creating Booklets](#)

[Copying and Creating Finished Booklets](#)

[Creating Folded, Stapled, or Punched Copies](#)

[Stacking Copies Using Orientation](#)

[Stacking Copies Using Offset](#)

[Inserting Slipsheets](#)

Parent topic: [Copying](#)

Copying and Creating Booklets

You can use your copied originals to create booklets. You can also add front and back covers to the booklet.

Note: If you do not have the optional finishing equipment installed on your machine, you will have to manually fold and staple your booklets.

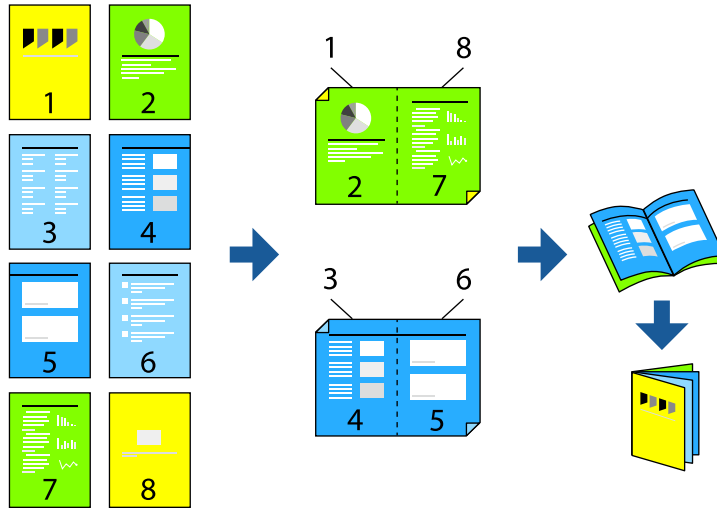

1. Place your originals on the ADF.
2. Press the  home button, if necessary.
3. Select **Copy**.
4. Select **Basic Settings** and then select **Paper Setting** and select the paper source for your copies.
5. Select **2-Sided** and then select either **2>2-Sided** or **1>2-Sided** depending on your originals.
6. Select other settings such as the original orientation and the binding position and then select **OK**.
7. If necessary, select **Reduce/Enlarge** and make any adjustments.
8. Select the **Advanced** tab and enable the **Booklet > Booklet** setting.
9. Specify the binding position and binding margin.
10. If you want to add covers to the booklet, enable the **Cover** setting.
11. Select **Paper Setting** and select the paper source for the covers, then select **Front Cover** and **Back Cover** and specify the print settings. Select **Do not Print** if you do not want a front or back cover.
12. When you are ready to copy, select the **Copy** icon.

Parent topic: [Copying, Sorting, and Creating Booklets](#)

Copying and Creating Finished Booklets

You can create folded and stapled booklets using your product, depending on the installed options. You can also add front and back covers to the booklet.

Note: This feature requires the optional staple finisher and saddle unit.

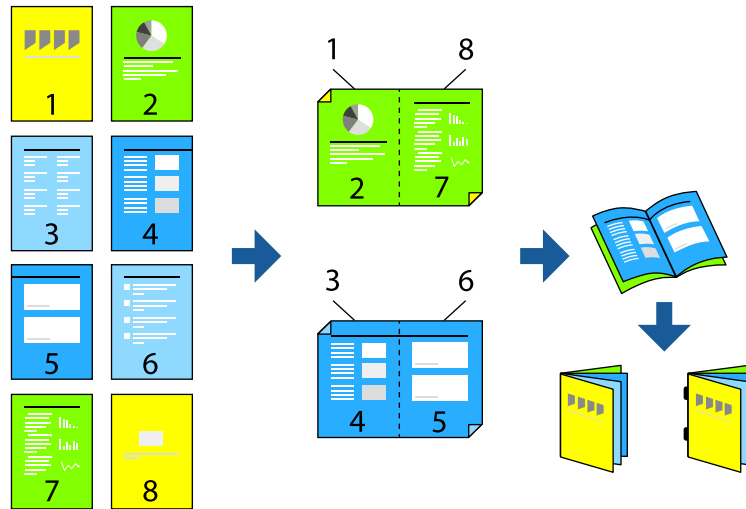

1. Place your originals on the ADF.
2. Press the  home button, if necessary.
3. Select **Copy**.
4. Select **Basic Settings** and then select **Paper Setting** and select the paper source for your copies.
5. Select **2-Sided** and then select either **2>2-Sided** or **1>2-Sided** depending on your originals.
6. Select other settings such as the original orientation and the binding position and then select **OK**.
7. If necessary, select **Reduce/Enlarge** and make any adjustments.
8. Select the **Advanced** tab and enable the **Booklet > Booklet** setting.
9. Specify the binding position and binding margin and select **OK**.
10. If you want to add covers to the booklet, enable the **Cover** setting.
11. Select either **Saddle Stitch** or **Half Fold** and enable the setting.

12. Select other settings such as the number of sheets per fold or staple.
13. When you are ready to copy, select the **Copy** icon.

Note: Make sure there are no booklets or paper in the booklet output tray or you will not be able to start printing.

Parent topic: [Copying, Sorting, and Creating Booklets](#)

Creating Folded, Stapled, or Punched Copies

You can add folds, staples, or punch holes to your copies.

Note: You will need the following installed accessories depending on your output:

- Folded copies: Staple finisher and saddle unit
- Stapled copies: Inner or staple finisher
- Punched copies: Inner or staple finisher and punch unit

1. Place your originals on the ADF.
2. Press the  home button, if necessary.
3. Select **Copy**.
4. Select **Basic Settings** and then select **Paper Setting** and select the paper source for your copies.
5. Do one of the following:
 - To fold your copies, select the **Advanced** tab and select **Fold**, then enable the **Half Fold** or **Tri Fold** setting. Specify the details such as the number of sheets per fold.
 - To staple your copies, select **Finishing** > **Staple** and select the staple position.

Note: You can also manually staple your copies with the optional staple finisher.

- To add punch holes to your copies, select **Finishing** > **Punch** and select the punch hole location.

Note: Adjust the print data so that you do not print at the punch location. This can cause a punch failure or a paper jam. Select **Advanced** > **Binding Margin** and make sure the binding width is at least 0.73 inches (18.5 mm).

6. When you are ready to copy, select the **Copy** icon.

Parent topic: [Copying, Sorting, and Creating Booklets](#)

Stacking Copies Using Orientation

You can sort and stack your output by alternately rotating each copy by 90 degrees.

Note: Rotated stacking is not available if the staple finisher is installed.

1. Place your originals on the ADF.
2. Press the  home button, if necessary.
3. Select **Copy**.
4. Select **Basic Settings > Finishing > Eject Paper > Rotate Sort**.
5. Check the following settings:
 - This feature uses two paper sources. Load paper in portrait orientation in one source, and in landscape orientation in the second paper source. Select **Paper Setting** and set it to **Auto**.
 - On the home screen, select **Settings > General Settings > Printer Settings > Output: Copy** and make sure that the **Face Down Tray** is selected.
6. When you are ready to copy, select the **Copy** icon.

Parent topic: [Copying, Sorting, and Creating Booklets](#)

Stacking Copies Using Offset

You can sort and stack your output by offsetting each copy for easy separation.

Note: Offset stacking requires the optional staple finisher or inner finisher.

1. Place your originals on the ADF.
2. Press the  home button, if necessary.
3. Select **Copy**.
4. Select **Basic Settings > Finishing > Eject Paper > Shift Sort**.
5. Set the number of copies.
6. When you are ready to copy, select the **Copy** icon.

Parent topic: [Copying, Sorting, and Creating Booklets](#)

Inserting Slipsheets

You can insert slipsheets into or between your copies.

1. Place your originals on the ADF.
2. Press the  home button, if necessary.
3. Select **Copy**.
4. Select **Advanced > Cover & Slip Sheet > Slip Sheet**.
5. Select **End of Job** or **End of Set**, enable the setting and then specify any other settings as necessary.

If you want to specify the page to insert the slipsheet, select **End of Page or Chapter** and specify any other settings as necessary.

6. Specify the number of copies.
7. When you are ready to copy, select the **Copy** icon.

Parent topic: [Copying, Sorting, and Creating Booklets](#)

Copying Options

Select the copying options you want to use for your copies.

Note: Not all options or settings may be available, depending on other copying settings.

Basic Settings

Copying option	Available settings	Description
Auto	—	Copies the document in the detected color of the original.
B&W	—	Copies the document in black and white.
Color	—	Copies the document in color.
Density	Varying levels	Adjusts the lightness or darkness of copies.
Paper Setting	Various sources	Select the paper source that you want to use. If you select Auto , paper is fed automatically depending on the paper settings you selected for the paper sources.

Copying option	Available settings	Description
Reduce/Enlarge	Auto	Automatically sizes the image to fit the paper size you selected.
	Reduce to Fit Paper	Automatically decreases the size of the image by the percentage you select.
	100%	Displays the conversion percentage. Use the + and - icons to adjust the percentage in increments of 1 or select the value and use the on-screen keypad to enter a percentage.
	Free Form (mm)	Specifies the size of the target paper in millimeters.
	Free Form (%)	Specify different magnifications for the vertical and horizontal lengths of the original to enlarge or reduce it.
	Actual Size and other conversions	Copies the original at its full size or automatically converts from one size to another.
	Various paper sizes	Automatically enlarges or reduces the original to fit a specific paper size
Original Type	Text	Specifies the document type of your originals and adjusts the quality of your copies.
	Text & Image	
	Photo	
	Barcode	
2-Sided	1>1-Sided	Select to make 2-sided copies. When you select 1>2-Sided or 2>1-Sided , you can select the orientation and binding edge for your originals or copies.
	2>2-Sided	
	1>2-Sided	
	2>1-Sided	
Multi-Page	Single Page	Copies each page of the original onto an individual sheet.
	2-up	Copies multiple page documents onto one sheet. Scroll down and select the document orientation and layout order settings as necessary.
	4-up	

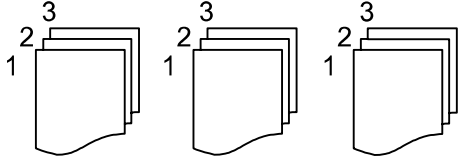
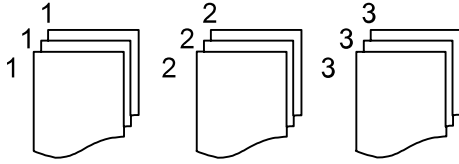
Copying option	Available settings	Description
Finishing	Collate (Page Order)	Select to print multiple copies of a multi-page document in ordered sets. 
	Group (Same Pages)	Select to print multiple copies of a multi-page document in unordered groups. 
	Eject Paper	Select Rotate Sort to print alternate paper orientations and paper sources (make sure the Paper Setting is set to Auto for this option). Select Shift Sort* to offset each set of copies.
	Staple*	Select the staple location.
	Punch**	Select the location for the punch holes

* Displayed when the optional staple finisher is installed.

** Displayed when the optional punch unit is installed.

Advanced settings

Copying option	Available settings	Description
Booklet	Booklet	Adjust these settings to create a booklet from your copies. See the table below.
	Saddle Stitch	<p>Saddle Stitch: Allows you to saddle stitch the copies using staples</p> <p>Sheets per Staple: Specify the number of pages for each stapled section</p> <p>Split: Allows you to print separately</p> <p>Cover: Allows you to add the covers to the copies</p> <p>Paper Setting: Select the paper source in which you loaded the paper for the covers.</p>
	Half Fold	<p>Half Fold: Allows you to fold the copies in half</p> <p>Sheets per Fold: Specify the number of page for each folded section</p> <p>Split: Allows you to print separately</p> <p>Cover: Allows you to add the covers to the copies</p> <p>Paper Setting: Select the paper source in which you loaded the paper for the covers.</p> <p>Print Mode: Select whether to print inside or outside the half-folded paper</p>

Copying option	Available settings	Description
Fold	Half Fold	<p>Half Fold: Allows you to fold the copies in half</p> <p>Sheets per Fold: Specify the number of page for each folded section</p> <p>Split: Allows you to print separately</p> <p>Cover: Allows you to add the covers to the copies</p> <p>Paper Setting: Select the paper source in which you loaded the paper for the covers.</p> <p>Print Mode: Select whether to print inside or outside the half-folded paper</p>
	Tri Fold	<p>Tri Fold: Allows you to fold the copies in half</p> <p>Sheets per Fold: Specify the number of page for each folded section</p> <p>Print Mode: Select whether to print inside or outside the half-folded paper</p> <p>Open Orientation: Select the direction in which the folded booklet will open</p>
Cover & Slip Sheet	Cover	Adjust these settings to add covers to your copies.
	Slip Sheet	Adjust these settings to insert slip sheets into your copies.
Original Size	Various sizes	Select the document size of your original.
Mixed Size Originals	Off	Select On to copy originals of varying sizes in their original sizes.
	On	
Orientation (Original)	Readable Direction	Specifies the orientation of your originals.
	Left Direction	
Book>2Pages	Off	Select On to copy two pages of a book onto separate sheets of paper. You can also choose the Scan Order .
	On	
Continuous Scanning	Off	Select On to scan a large quantity of originals placed in the ADF as one job.
	On	
Image Quality	Various settings	Select advanced quality settings such as Saturation and Sharpness .

Copying option	Available settings	Description
Binding Margin	Off	Select On to adjust the margin and orientation of the pages when copying a book. You can also select the Binding Position and Orientation . Select Binding Width to shift the image out of the binding margin, Reduce to Fit Paper to shrink the image to fit into the printing area, or Erase Image Over Margin to only print the part of the image that is outside of the binding margin.
	On	
Reduce to Fit Paper	Off	Select On to automatically decrease the image by the percentage you select.
	On	
Remove Shadow	Off	Select On to erase the shadows that appear in the center of a document when copying a book or that appear around a document when copying thick paper.
	On	
Remove Punch Holes	Off	Select On to erase the binding holes on a document. You can also select the Erasing Position and Orientation .
	On	
ID Card Copy	Off	Select On to copy both sides of an ID card onto one side of a sheet of paper. You can also select the Orientation .
	On	
Proof Copy	—	When making multiple copies, you can start with one copy to check the results, and then copy the rest.
Output Tray	Various settings	Select the output tray for your copies.
Stamp	Stamp	Select On to print stamps on your copies.
	Type	Select the stamp type.
	Stamp Position	Select the stamp position.
	Print Page	Select the page you want to stamp.
	Size	Select the stamp size.
	Print Color	Select the stamp color.
	Transparency	Select whether the stamp is transparent.

Copying option	Available settings	Description
Date Stamp	Date Stamp	Select On to print date stamps on your copies.
	Date Format	Select the date format.
	Stamp Position	Select a location for the date stamp.
	Size	Select a size for the date stamp.
	Background	Select whether or not to make the date stamp's background white. If you select White , you can see the date stamp clearly when the background for the data is not white.
Page Numbering	Page Numbering	Select On to print page numbers on your copies.
	Format	Selects the page numbering format.
	Stamp Position	Selects where the page number is placed on each copy.
	Change Numbering	Specifies on which page numbering begins.
	Size	Adjusts the font size of the page numbers.
	Background	Adjusts the background color of the page number.
File Storing	—	Select On to save the copied file to the product's internal storage. Adjust the save settings, including whether to print and save the copied file or to only save the file.
Print Sets	Various settings	Allows you to copy the document in groups of saved quantities and settings.
Erase Red Color	Off	Select On to print copies with any red characters in the original omitted.
	On	

Booklet settings

Copying option	Description
Booklet	Allows you to create a booklet from your copies
Binding	Select the binding position of the booklet
Binding Margin	Specify the binding margin up to a maximum of 50 mm in 1 mm increments
Cover	Allows you to add covers to the booklet
Paper Setting	Select the paper source in which you loaded the paper for the covers

Copying option	Description
Front Cover	Specify the print settings for the front cover. If you do not want to print on the front cover, select Do not Print
Back Cover	Specify the print settings for the back cover. If you do not want to print on the back cover, select Do not Print

Parent topic: [Copying](#)

Saving Groups for Copying

You can save groups of frequently used copy quantities and sets so that you can print or copy without entering the number of copies each time. This is useful when you are printing a different number of copies for each set.

Note: You can save up to 60 print set groups and enter up to 99 sets and 9999 copies. Print set groups are also accessible when printing a file from a storage folder.

Note: This feature requires a registered license key.

1. Press the  home button, if necessary.
2. Select **Copy**.
3. Select **Advanced** and then select **Print Sets**.
4. Select **Not Set** from the list.
5. Select **Register/Overwrite** and enter a group name.
6. Set the number of copies and sets on the **Copies & Sets** tab.

Note: You can enter up to 9999 copies and 99 sets.

7. Select any other settings as necessary.
8. Select **OK** to save.

Parent topic: [Copying](#)

Editing or Deleting a Saved Group for Copying

You can edit or delete a print set group.

1. Press the  home button, if necessary.
2. Select **Copy**.
3. Select **Advanced** and then select **Print Sets**.
4. Select the group you want to edit or delete from the list.
5. Do one of the following:
 - Select **Register/Overwrite** to edit the group and modify the settings as desired. Proceed to the next step.
 - Select **Delete** to delete the group. You are done.
6. Select **OK** to save.

Parent topic: [Copying](#)

Omitting Red Characters in Originals When Copying

You can set red characters in the originals to not be printed in copies.

Note: Depending on the original, red characters may still appear. If you select **Color** as the color mode, the copy itself will be monochrome but it is counted as a color copy. If you select **Auto** as the color mode and the scanner detects that the original is in color, it is counted as a color copy even if the copy itself is monochrome.

Note: This feature requires a registered license key.

1. Place your original document or photo on the scanner glass, or place multi-page documents in the ADF.
2. Press the  home button, if necessary.
3. Select **Copy**.
4. Select **Advanced** and then enable **Erase Red Color**.

Note: The preview screen displays an image of the original before red characters are removed.

5. Select the **Copy** icon.

Parent topic: [Copying](#)

Printing from a Computer

Before printing from your computer, make sure you have set up your product and installed its software from the Epson website.

Note: If you have an Internet connection, it is a good idea to check for updates to your product software on Epson's support website. If you see a Software Update screen, select **Enable automatic checking** and click **OK**. The update scans your system to see if you have the latest product software. Follow the on-screen instructions.

[Printing with the Standard Epson Printer Software - Windows](#)

[Printing with the Epson Standard Printer Software - Mac](#)

[Printing with the Epson Universal Print Driver - Windows](#)

[Printing with the PostScript \(PS3\) Printer Software - Windows](#)

[Printing with the PostScript \(PS3\) Printer Software - Mac](#)

[Printing from a Smartphone or Tablet](#)

[Cancelling Printing Using the Product Control Panel](#)

Printing with the Standard Epson Printer Software - Windows

You can print with the standard Epson printer software using any Windows printing program, as described in these sections.

Note: If you are using your Epson product with the Windows 10 S operating system, you cannot use the software described in this section. You also cannot download and install any Epson product software from the Epson website for use with Windows 10 S; you must obtain software only from the Windows Store.

[Synchronizing Printer Settings for Optional Units - Windows](#)

[Selecting Basic Print Settings - Windows](#)

[Selecting Double-sided Printing Settings - Windows](#)

[Selecting Finishing Options - Windows](#)

[Selecting Additional Print Options - Windows](#)

[Selecting a Printing Preset - Windows](#)

[Selecting Extended Settings - Windows](#)

[Printing Your Document - Windows](#)





Printing Slip Sheets and Chapter Papers
Saving Print Set Groups - Windows
Editing or Deleting a Saved Group
Locking Printer Settings - Windows
Entering a User ID and Password for Printing
Selecting Default Print Settings - Windows
Changing Automatic Update Options

Parent topic: [Printing from a Computer](#)

Synchronizing Printer Settings for Optional Units - Windows

You must sync the printer driver before you can use any optional equipment installed on the product.

1. Do one of the following:

- **Windows 11:** Click  and select **Settings > Bluetooth & devices > Printers & scanners**. Select your product and select **Printer properties**.
- **Windows 10:** Click  and select  (Settings) > **Devices > Printers & scanners**. Select your product and select **Manage > Printer properties**.
- **Windows 8.x:** Navigate to the **Apps** screen and select **Control Panel > Hardware and Sound > Devices and Printers**. Right-click your product and select **Printer properties**.
- **Windows 7:** Click  and select **Devices and Printers**. Right-click your product and select **Printer properties**.

2. Click the **Optional Settings** tab.

You see a window like this:

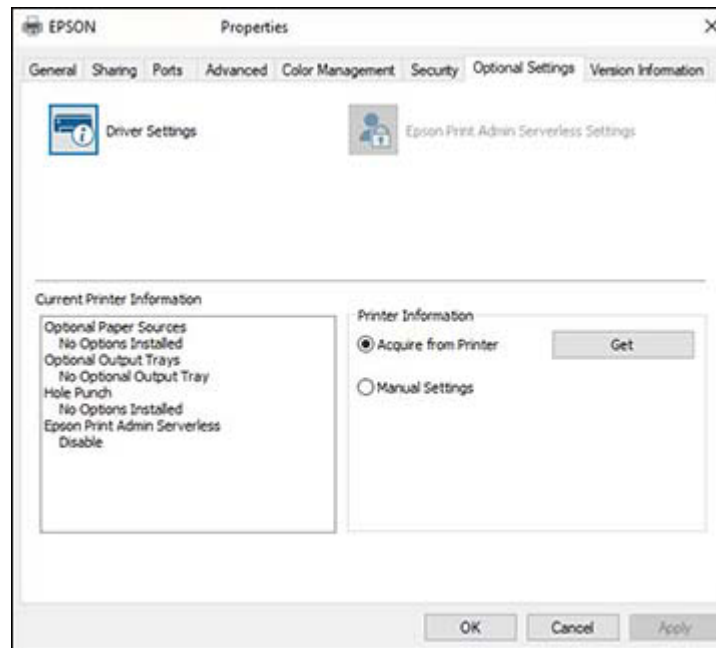

3. Make sure **Acquire from Printer** is selected and click **Get**.
The product's settings and other information appears in the Current Printer Information area.
4. If you want to select specific options to sync, select **Manual Settings** and click **Settings**. Select the options you want to sync and click **OK**.
5. Click **OK**.

Parent topic: [Printing with the Standard Epson Printer Software - Windows](#)

Selecting Basic Print Settings - Windows

Select the basic settings for the document or photo you want to print.

1. Open a photo or document for printing.

2. Select the print command in your application.

Note: You may need to select a print icon on your screen, the **Print** option in the **File** menu, or another command. See your application's help utility for details.

3. If necessary, select your product name as the printer you want to use.

Note: You may also need to select **More settings**, **Properties**, or **Preferences** to view your print settings.

You see the **Main** tab of your printer settings window:

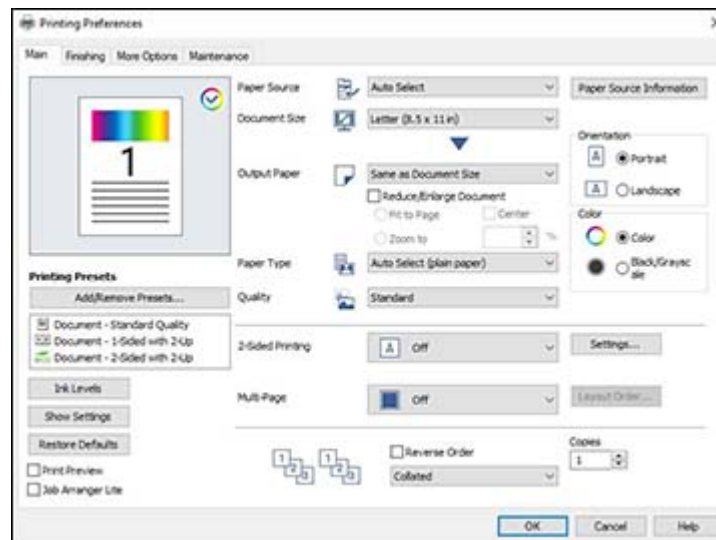

4. For the **Paper Source** setting, select where you loaded the paper you want to print on. Select **Auto Select** to automatically select the paper source in the paper setting menu on the product. You can also select **Cover Sheet/Separator Sheet** to set a different paper source for certain pages.

Note: Click **Paper Source Information** to view the paper type and size loaded in each paper cassette or the rear paper feeder.

5. Select the size of your document or photo as the **Document Size** setting, and the size of your paper as the **Output Paper** setting.
 - To change the size of your printed document or photo, select the **Reduce/Enlarge Document** checkbox.
 - Select the **Fit to Page** option to size your image to fit the paper you loaded.
 - Select the **Center** checkbox if you want to center your image on the paper.
 - Select the **Zoom to** option to reduce or enlarge your document or photo by a specific percentage. Select the percentage in the % dropdown.
6. Select the type of paper you loaded as the **Paper Type** setting. Select **Auto Select (plain paper)** to automatically use the paper type selected on the product control panel.

Note: The setting may not exactly match the name of your paper. Check the paper type settings list for details.

7. Select the **Quality** setting that matches the print quality you want to use.
8. Select the orientation of your document.

Note: If you are printing an envelope, select **Landscape**.

9. Select a Color option:
 - To print a color document or photo, select the **Color** setting.
 - To print text and graphics in black or shades of gray, select the **Black/Grayscale** setting.
10. To print on both sides of the paper, select a **2-Sided Printing** option and click **Settings** to select printing options.
11. To print multiple pages on one sheet of paper, or print one image on multiple sheets of paper, select one of the **Multi-Page** options and click **Layout Order** to select the printing options.
12. To print multiple copies and arrange their print order, select the **Copies**, **Reverse Order**, and **Collated** options.
13. To preview your job before printing, select the **Print Preview** checkbox.
14. To save your print job as a project that can be modified and combined with other print jobs, select **Job Arranger Lite**.

[Paper Source Options - Windows](#)

[Multi-Page Printing Options - Windows](#)

Parent topic: [Printing with the Standard Epson Printer Software - Windows](#)

Related tasks

[Printing Slip Sheets and Chapter Papers](#)

Paper Source Options - Windows

You can select any of the available options in the Paper Source menu to print on the paper loaded in that source.

Note: Paper Cassette 3 and Paper Cassette 4 are available only if you have installed the additional cassette unit.

Auto Select

Automatically selects the paper source based on the selected paper size.

Paper Tray

Selects the paper in the paper tray as the paper source.

Paper Cassette 1

Selects the paper in cassette 1 as the paper source.

Paper Cassette 2

Selects the paper in cassette 2 as the paper source.

Paper Cassette 3

Selects the paper in cassette 3 as the paper source.

Paper Cassette 4

Selects the paper in cassette 4 as the paper source.

High Capacity Tray

Selects the optional high capacity tray as the paper source if it is connected to the printer.

Cover Sheet/Separator Sheet

Set a different paper source for the first paper and subsequent papers.

Parent topic: [Selecting Basic Print Settings - Windows](#)

Multi-Page Printing Options - Windows

You can select any of the available options in the Multi-Page menu to set up your multi-page print job.

2-Up, 4-Up, 6-Up, 8-Up, 9-Up, and 16-Up

Prints several pages on one sheet of paper. Click the **Layout Order** button to select page layout and border options.

2×1 Poster, 2×2 Poster, 3×3 Poster, 4×4 Poster

Prints one image on multiple sheets of paper to create a larger poster. Click the **Settings** button to select image layout and guideline options.

Parent topic: [Selecting Basic Print Settings - Windows](#)

Selecting Double-sided Printing Settings - Windows

You can print on both sides of the paper by selecting one of the 2-Sided Printing options on the Main tab.

Note: Some options may be pre-selected or unavailable, depending on other settings you have chosen or if you are accessing the product over a network.

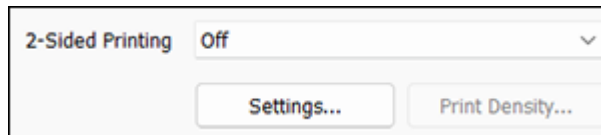

1. Select one of the following options for **2-Sided Printing**:
 - **Auto (Long-edge binding)** to print your double-sided print job by automatically flipping the paper on the long edge.
 - **Auto (Short-edge binding)** to print your double-sided print job by automatically flipping the paper on the short edge.
2. Click the **Settings** button.

You see this window:

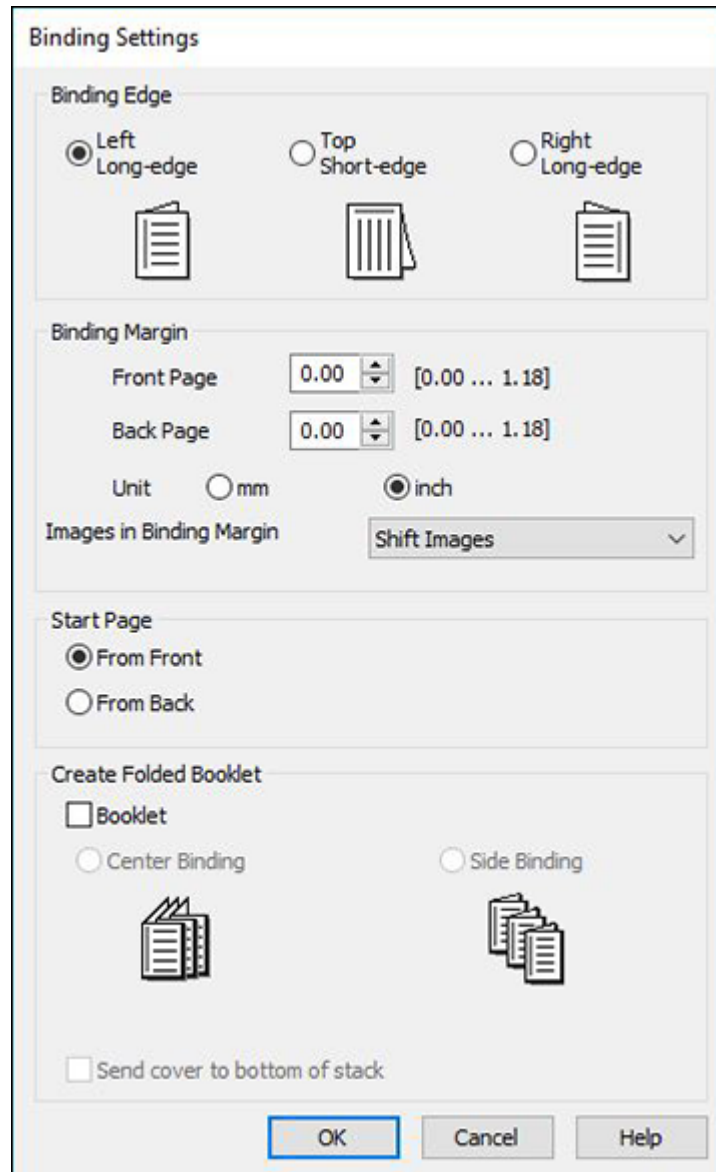

3. Select the double-sided printing options you want to use.
4. Select an option from **Images in Binding Margin** to change how the binding margin affects images.
 - **Shift Images**: Moves images out of the binding margin.
 - **Reduce Images**: Scales down images so that they are not in the binding margin.
 - **Erase Images**: Only prints parts of images outside of the binding margin.
5. Click **OK** to return to the Main tab.
6. Print a test copy of your double-sided document to test the selected settings.
7. Follow any instructions displayed on the screen during printing.

[Double-sided Printing Options - Windows](#)

Parent topic: [Printing with the Standard Epson Printer Software - Windows](#)

Double-sided Printing Options - Windows

You can select any of the available options on the 2-Sided Printing Settings window to set up your double-sided print job.

You can right-click a setting in the dialog and select **Help** for additional information on each setting.

Binding Edge Options

Select a setting that orients double-sided print binding in the desired direction.

Binding Margin Options

Select options that define a wider margin to allow for binding.

Start Page

Selects whether printing starts on the front or back page.

Create Folded Booklet Options

Select the **Booklet** checkbox and a binding option to print double-sided pages as a booklet.

Parent topic: [Selecting Double-sided Printing Settings - Windows](#)

Selecting Finishing Options - Windows

You can select a variety of finishing options for your document or photo on the Finishing tab.

1. To store print jobs in the product's memory, select one of the **Job Type** options:
 - Select **Normal Print** to print jobs without storing them.
 - Select **Confidential Print** to add a password to a print job.

Note: Confidential jobs are stored in the product's memory without being printed. To print the job, enter the password for the confidential job on the product's control panel. Confidential print jobs are cleared from the product's memory after printing. If the product is turned off or restarted before the confidential job is printed, the job is cleared from the product's memory.

- When printing multiple copies, select **Verify Job** to print one copy to verify content and settings. You can then continue printing from the product control panel.
 - Select **Re-Print Job** to store a print job in the product's memory. You can then print from the product control panel.
 - Select **Save to Storage** to save the file to the product's hard drive without printing it.
 - Select **Save to Storage and Print** to print the file and save it to the product's hard drive.
2. Select the **Paper Source** and **Output Tray** options you want to use.
 3. Select **Cover Sheet/Separator Sheet** and select the appropriate option if you want to print a blank sheet of paper in between copies or print jobs.

Note: You can also adjust this setting from the control panel using the **Insert Sheets per User** option.

4. Select one of the following **Sort** options:
 - Select **Rotate Sort** to stack printouts alternately in landscape and portrait orientations. The **Paper Source** setting must be set to **Auto Select** and the **Output Tray** setting must be set to either **Auto Select** or **Face Down Tray**.
 - Select **Shift Sort** to offset each set of copies. The **Output Tray** setting must be set to **Finisher Tray** or **Auto Select**.

Note: This option is available only when the optional finisher unit is installed.

5. If the optional finisher and punch units are installed, you can choose the following options:
 - Select a **Staple** option to choose the staple location on the document.
 - Select a **Punch** option to choose where the holes are punched.

Caution: When using the optional hole punch unit with the optional staple or booklet finisher, adjust the printed area so it does not overlap with the holes being punched. You should also set the binding margin so that it is not printed at the hole punch position. Punching holes over any printed area may cause hole punch failure or a paper jam.

- Select a **Fold/Saddle Stitch** option to choose the booklet settings.
6. When printing documents of mixed sizes, select **Specify Orientation**. Click **Settings** to select orientation and binding margin options.

[Finishing Options - Windows](#)

[Using the Manual Stapler](#)

Parent topic: [Printing with the Standard Epson Printer Software - Windows](#)

Related tasks

[Printing Slip Sheets and Chapter Papers](#)

Finishing Options - Windows

You can select any of the Finishing options to customize your print. Some options may be pre-selected or unavailable, depending on other settings you have chosen.

Job Type

Select whether to store a print job in the product's memory.

Paper Source

Select the paper cassette or tray to use.

Output Tray

Select where printed jobs are output.

Sort

Select how to sort print jobs with multiple copies.

Staple

Select the staple location for printed documents.

Punch

Select the hole punch location for printed documents.

Fold/Saddle Stitch

Select binding settings for folded or folded and saddle stitched printed documents.

Note: The **Staple**, **Fold/Saddle Stitch**, and **Punch** options are available only when the necessary options are installed.

Parent topic: [Selecting Finishing Options - Windows](#)

Using the Manual Stapler

The optional staple finisher can be used to manually staple documents.

The maximum number of pages that can be stapled depends on the size and paper weight of the documents to be stapled.

Paper size: A4 or Letter:

- 60 to 90 g/m²: 50 sheets
- 91 to 105 g/m²: 40 sheets

Paper size: A3 or Legal:

- 60 to 90 g/m²: 30 sheets
- 91 to 105 g/m²: 20 sheets

1. Press the staple position switching button.

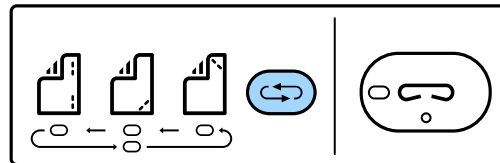

The shutter of the paper output unit of the finisher tray opens and the manual staple mode is enabled.

2. Set the staple position by pressing the staple position button until the green light is shown under the desired position.

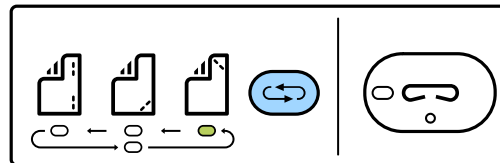

3. Load paper with the printable side facing down and the shutter for the paper finisher tray open. Adjust the paper orientation according to the staple position.

Caution: Do not place your hand into the opening of the paper output unit.

Note: Press the staple position switching button before loading paper. You cannot change the position when paper is loaded. When paper is loaded correctly the staple button light turns on. If the light does not turn on, load the paper again.

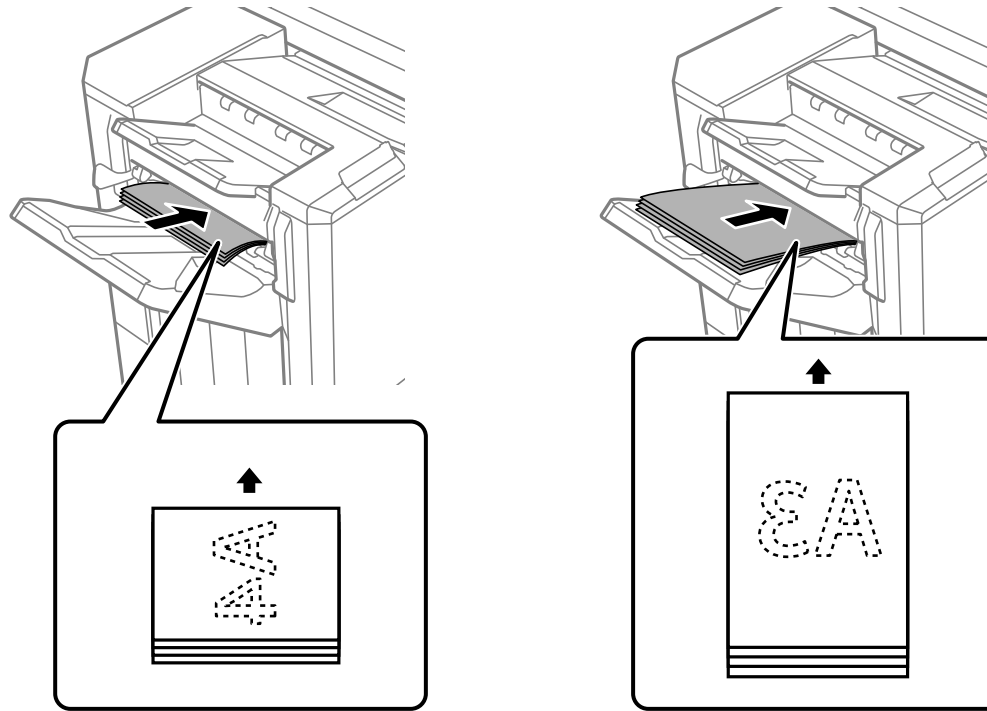

4. Press the staple button to staple the paper. Do not touch the paper while stapling.
5. To exit manual stapling mode, press the staple position switching button several times to turn the light off.

Parent topic: [Selecting Finishing Options - Windows](#)

Selecting Additional Print Options - Windows

You can select a variety of additional printing options for your document or photo on the More Options tab.

1. Select one of the following Color Correction options:
 - Select **Automatic** to automatically adjust the sharpness, brightness, contrast, and color saturation for your image.
 - Select **Custom** and click the **Advanced** button to manually adjust the color correction settings or turn off color management in your printer software.
 - Select **Image Options** to access additional settings for improving printed images.
2. To add the following features, click the **Watermark Features** button:
 - **Anti-copy Pattern**: adds a watermark that only appears when your printout is copied
 - **Watermark**: adds a visible watermark to your printout
 - **Header/Footer**: adds information such as the date and time to the top or bottom of your printout
3. Select **Rotate 180°** to print the image rotated 180° from its original orientation.
4. Select **Print Sets** to print the document in groups of saved quantities and settings.

Note: Click the **Settings** button to customize the groups. This feature requires an activated license key.

[Custom Color Correction Options - Windows](#)

[Image Options and Additional Settings - Windows](#)

[Header/Footer Settings - Windows](#)

Parent topic: [Printing with the Standard Epson Printer Software - Windows](#)

Custom Color Correction Options - Windows

You can select any of the available options in the Color Correction window to customize the image colors for your print job.

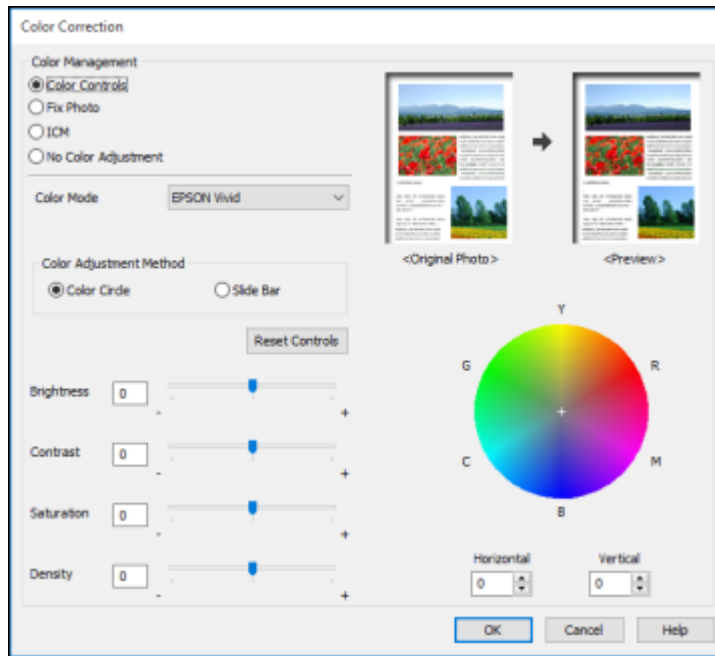

Color Controls

Lets you select a **Color Mode** setting, individual settings for **Brightness**, **Contrast**, **Saturation**, and **Density**, and individual color tones. Depending on the selected color mode, you can also adjust the midtone density using the **Gamma** setting.

Fix Photo

Improves the color, contrast, and sharpness of flawed photos.

Note: Fix Photo uses a sophisticated face recognition technology to optimize photos that include faces. For this to work, both eyes and the nose must be visible in the subject's face. If your photo includes a face with an intentional color cast, such as a statue, you may want to turn off **Fix Photo** to retain the special color effects.

ICM

Lets you manage color using installed color printing profiles.

No Color Adjustment

Turns off color management in your printer software so you can manage color using only your application software.

Parent topic: [Selecting Additional Print Options - Windows](#)

Image Options and Additional Settings - Windows

You can select any of the Image Options and Additional Settings to customize your print. Some options may be pre-selected or unavailable, depending on other settings you have chosen.

Image Options**Emphasize Text**

Adjusts the weight of printed text to increase readability.

Emphasize Thin Lines

Adjusts the weight of printed lines to increase visibility.

Edge Smoothing

Smooths jagged edges in low-resolution images such as screen captures or images from the Web.

Fix Red-Eye

Reduces or removes red-eye in photos.

Print Text in Black

Prints colored text in black.

For Color Text

Prints colored text on a background pattern or underlined.

For Color Graphs and Images

Prints colored graphics and images with overlay patterns.

For Color Text, Graphs, and Images

Prints colored text, graphics, and images with overlay patterns.

Enhancement Options

Specifies Color Universal Print enhancement settings for text, graphics, and images.

Additional Settings Options**Rotate 180°**

Prints the image rotated 180° from its original orientation.

Parent topic: [Selecting Additional Print Options - Windows](#)

Header/Footer Settings - Windows

You can select any of the Header/Footer Settings options to add headers or footers when you print. The items are available to print at the top or bottom of your pages, in either the left, right, or center of the page.

Note: These settings are not saved with your document.

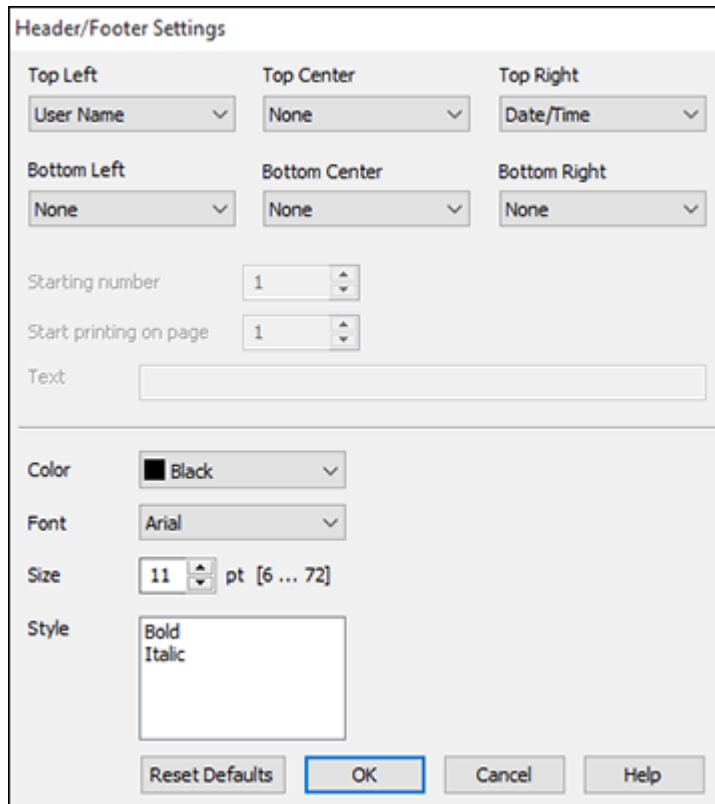

The screenshot shows the 'Header/Footer Settings' dialog box. It is organized into several sections:

- Header/Footer Selection:** A grid of six dropdown menus for selecting content to print in different positions:
 - Top Left: User Name
 - Top Center: None
 - Top Right: Date/Time
 - Bottom Left: None
 - Bottom Center: None
 - Bottom Right: None
- Page Settings:** Two spinners for 'Starting number' and 'Start printing on page', both set to 1.
- Text:** An empty text input field.
- Appearance:** Settings for 'Color' (Black), 'Font' (Arial), and 'Size' (11 pt).
- Style:** A checkbox area for 'Bold' and 'Italic'.
- Buttons:** 'Reset Defaults', 'OK', 'Cancel', and 'Help' buttons at the bottom.

You can select to print the following information:

- User Name
- Computer Name
- Date

- Date/Time
- Document Name
- Collate Number
- Page Number
- Text

You can also adjust the text settings for the printed information.

Note: The user name, computer name, date, and time come from the Windows Control Panel on your computer.

Parent topic: [Selecting Additional Print Options - Windows](#)

Selecting a Printing Preset - Windows

For quick access to common groups of print settings, you can select a printing preset on the **Main** or **More Options** tab.

Note: You can create your own preset by clicking the **Add/Remove Presets** button.

1. Click the **Main** or **More Options** tab.

You see the available **Printing Presets** on the left:

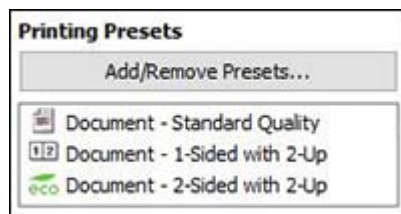



2. Place your cursor over one of the **Printing Presets** to view its list of settings.
3. Click on a preset to change its settings or delete it, or use any of the available options on the screen to control your printing presets.
4. To choose a preset for printing, select it.
5. Click **OK**.

Parent topic: [Printing with the Standard Epson Printer Software - Windows](#)

Selecting Extended Settings - Windows

You can select additional settings that apply to all the print jobs you send to your product.

1. Access the Windows Desktop and right-click the  icon for your product in the right side of the Windows taskbar, or click the up arrow and right-click .

Note: For Windows 11, you may need to select  and select **Settings > Bluetooth & devices > Printers & scanners**. Select your product and select **Printing preferences**.

2. Click the **Maintenance** tab.
3. Click the **Extended Settings** button.

You see a window like this:

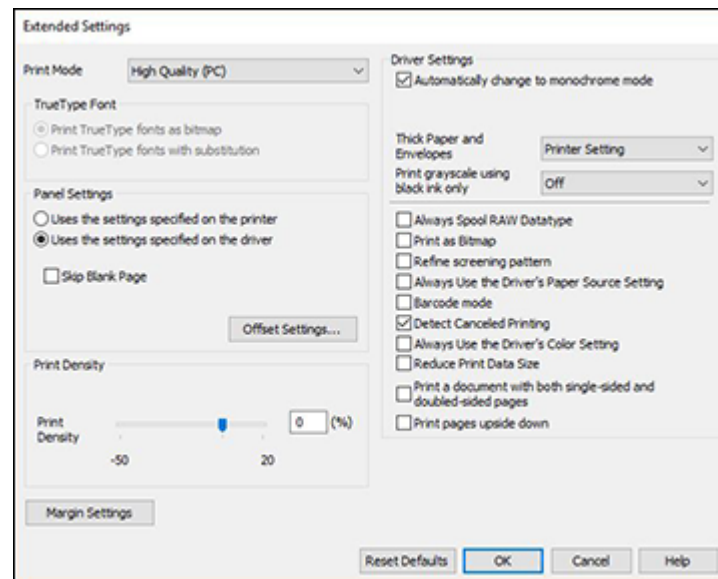

4. Select any of the extended settings to customize your print.
5. Click **OK** to close the Extended Settings window.

6. Click **OK** to close the printer software window.

[Extended Settings - Windows](#)

Parent topic: [Printing with the Standard Epson Printer Software - Windows](#)

Extended Settings - Windows

You can select from these settings on the Extended Settings window.

Print Mode

Selects how print jobs are processed by the computer's or product's memory.

TrueType Font

Lets you select how you want to print TrueType fonts.

Panel Settings

Prioritizes settings from the product control panel or the printer driver software.

Skip Blank Page

Ensures that your product does not print pages that contain no text or images.

Offset Settings

Lets you make fine-tune adjustments to the print position of data on your printout.

Print Density

Sets the level of ink coverage for double-sided printing.

Margin Settings

Sets the printer margins.

Automatically change to monochrome mode

Select to print automatically in monochrome instead of color.

Optimize Finishing

Reduces paper misalignment to improve stapling and stacking printouts. Print speed is decreased.

Note: Displayed when the optional finisher unit is installed.

Thick Paper and Envelopes

Select an option to prevent ink from smearing when you print on envelopes or other thick paper.

Print grayscale using black ink only

Prints in grayscale using only black ink.

Change Standard Resolution

Reduces the resolution of print data to correct printing problems.

Always Spool RAW Datatype

Increases print speed and may solve other printing problems.

Print as Bitmap

Increases print speed when printing is extremely slow or the print head stops during printing, and other settings do not help.

Refine screening pattern

Prints graphics with a finer screening pattern.

Always Use the Driver's Paper Source Setting

Prints using the paper source setting in the printer driver, rather than the setting in your application.

Barcode mode

Reduces bleeding when printing barcodes on plain paper, letterhead paper, recycled paper, preprinted paper, envelopes, and thick paper.

Detect Canceled Printing

Displays a message on the computer screen when a print job is canceled from the product control panel.

Always Use the Driver's Color Setting

Prioritizes color settings from the printer driver software.

Reduce Print Data Size

Increases print data compression to improve print speed. Not recommended when printing fine patterns.

Print a document with both single-sided and double-sided pages

Prints an entire document that contains both single- and double-sided pages.

Print pages upside down

Prints pages upside down when printing double-sided.

Output 1 page documents in 2-sided mode

When you print a one page document with this option enabled, the page will face the same direction as page 1 of a 2-sided document. This option is only available when you use the 2-Sided Printing feature.

High-compression data mode

Compresses print data, which may improve print speed, especially when printing multi-page documents.

Parent topic: [Selecting Extended Settings - Windows](#)

Printing Your Document - Windows

Once you have selected your print settings, you are ready to save your settings and print.

1. Click **OK** to save your settings.

You see your application's Print window, such as this one:

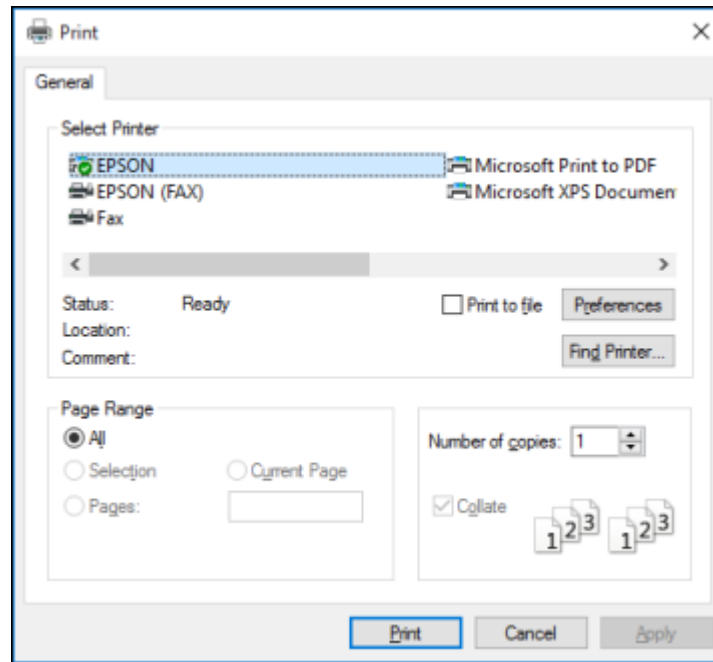

2. Click **OK** or **Print** to start printing.

Parent topic: [Printing with the Standard Epson Printer Software - Windows](#)

Printing Slip Sheets and Chapter Papers

When printing a document with multiple chapters, you can insert a slip sheet (blank page) between certain pages of your document, and you can print chapter papers (pages of a document set to be printed from specific paper sources on the product).

Note: Slip sheets and chapter papers are not available if you select **Job Type > Save to Storage** or **Save to Storage and Print**. The following settings are unavailable when printing slip sheets or chapter papers:

- **Multi-page**

- **Reverse Order**
- **Send cover to bottom of stack**
- **Extended Settings > Print a document with both single-sided and double-sided pages**
- Bookbinding printing
- Select whether to print the first page of paper on the front or back when printing double-sided

1. Load the papers you want to use for your print job in the product's paper sources.
2. Open the file you want to print on your computer and then select the print command in your application.

You see a window like this:

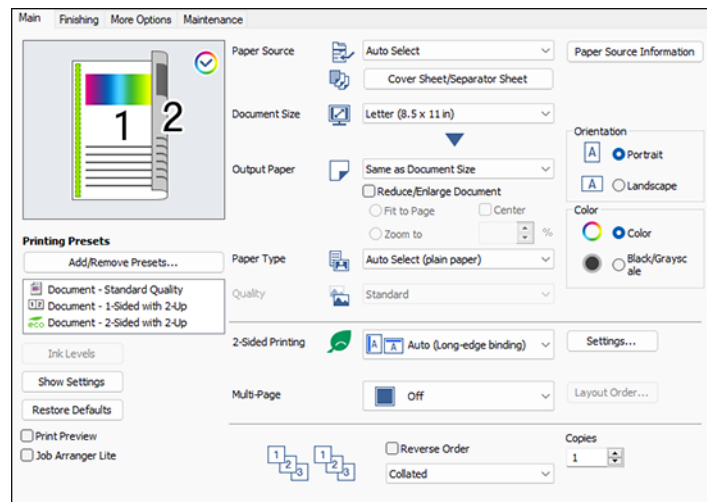

3. On the Main tab, select a **2-Sided Printing** setting for your print job.
4. Select **Cover Sheet/Separator Sheet** under the Paper Source setting.

The Cover Sheet/Separator Sheet Settings window appears.

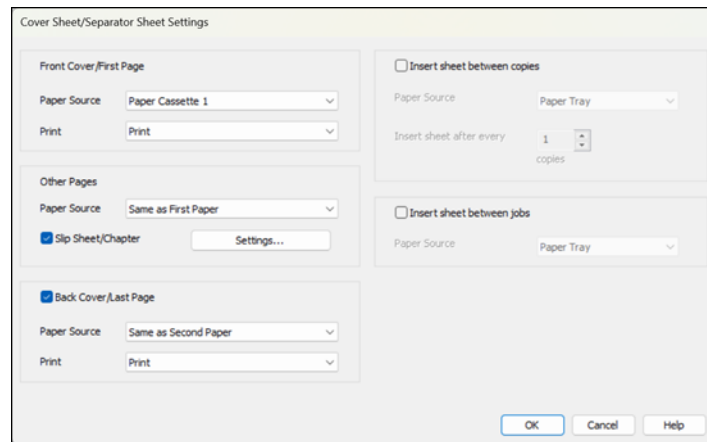

5. Adjust the settings for the first and last pages, as needed.
6. To make settings for pages other than the first or last pages, select the **Slip Sheet/Chapter** checkbox, and then select **Settings**.

The Slip Sheet/Chapter Settings window appears.

Slip Sheet/Chapter Settings

Pages: 2

Paper Source: Paper Cassette 1

Print Chapter Pages

Change Save

No.	Pages	Paper Source	Print

Delete

OK Cancel Help

7. Enter the settings for specific pages and click **Save** for each entry.
 - To choose the location where you want to insert a slip sheet or print a chapter, use the **Pages** field. Use commas to separate pages and use hyphens to specify ranges. For example: When you want to insert a slip sheet before pages 2 and 9, enter "2,9". If you want to print pages 4 and 7 on the chapter paper, enter "4,7". If you want to print pages 4 to 7 on the paper in the specified paper source, enter "4-7".
 - To select the paper source for the entry, select **Paper Source** and select a paper source.

- If the entry is for a chapter page, select the **Print Chapter Pages** checkbox.
 - To modify an entry, select it and change the settings, then click **Change**.
 - To save an entry, select **Save**.
 - To delete an entry, select it from the list and click **Delete**.
8. Click **OK** to return to the Cover Sheet/Separator Sheet Settings window, and then click **OK** to return to the Main tab of the printer driver.
 9. Make any necessary settings on the Finishing and More Options tabs and then click **OK**.
 10. Click **Print**.

Parent topic: [Printing with the Standard Epson Printer Software - Windows](#)

Saving Print Set Groups - Windows

You can save frequently used print quantities and sets as groups so that you can print without entering the quantity each time. This is useful when you want to print a different number of copies for each set. You can also make finishing settings such as collate, slip sheet, and eject paper for the groups.

1. On the **More Options** tab, select **Print Sets** and then click **Settings**.
2. Set each item on the **Print Sets Settings** screen, then click **OK**.
3. Set the other items on the **More Options**, **Main**, and **Finishing** tabs as necessary, then click **OK**.
4. On the **Main** or **More Options** tab, click **Add/Remove Presets** in **Printing Presets**.
5. Enter a name and, if necessary, enter a comment.
6. Click **Save** and then click **Close**.

Parent topic: [Printing with the Standard Epson Printer Software - Windows](#)

Editing or Deleting a Saved Group

You can edit or delete a print set group.

1. Press the  home button, if necessary.
2. Select **Storage**.

You see a screen like this:

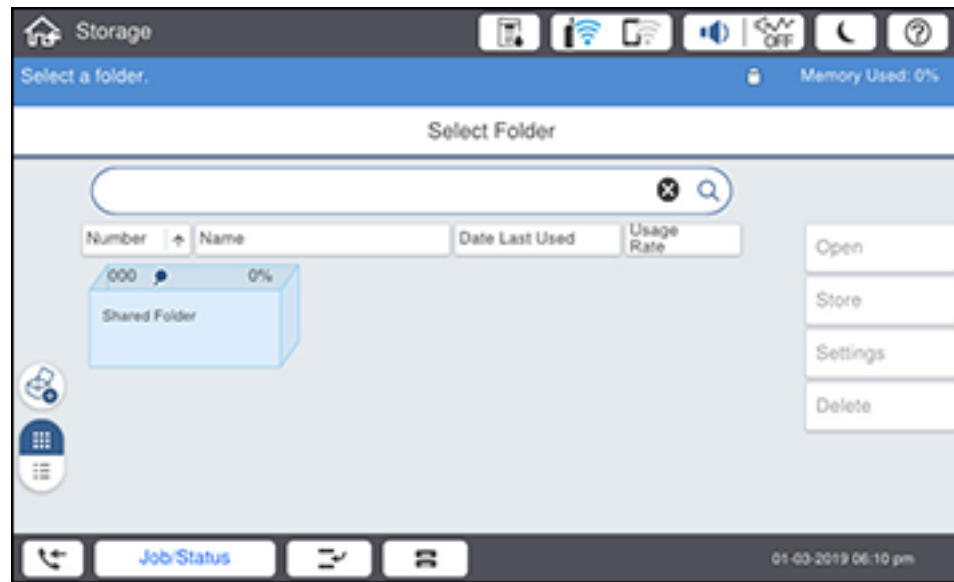

3. Select the folder containing the group you want to edit or delete and select **Open**.

You see a screen like this:

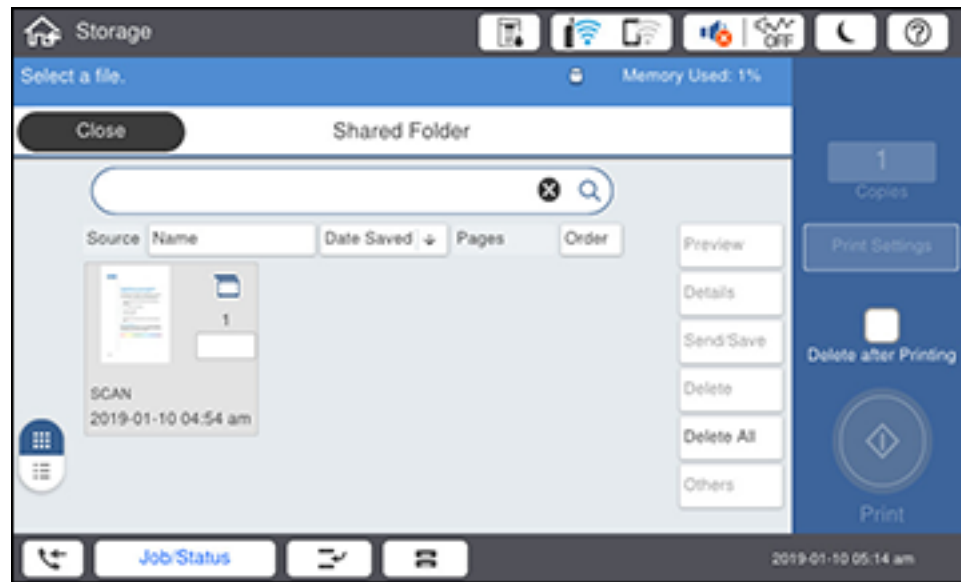

4. Select a file.

You see a screen like this:

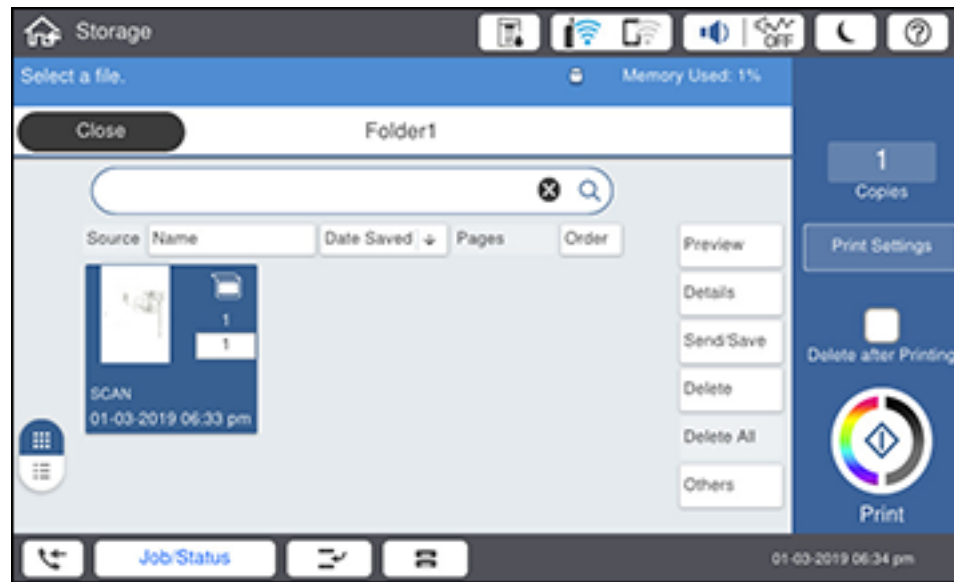





5. Select **Print Settings** and select **Advanced**.
6. Select **Print Sets** and then select the group you want to edit or delete from the list.
7. Do one of the following:
 - Select **Register/Overwrite** to edit the group and modify the settings as desired. Proceed to the next step.
 - Select **Delete** to delete the group. You are done.
8. Select **OK** to save.

Parent topic: [Printing with the Standard Epson Printer Software - Windows](#)

Locking Printer Settings - Windows

Windows administrators can lock access to some printer settings to prevent unauthorized changes.

1. Do one of the following:
 - **Windows 11:** Click , search for **Settings** and select it. Select **Bluetooth & devices > Printers & scanners**. Select your product name and select **Printer properties**.

- **Windows 10:** Click  and select  (Settings) > **Devices** > **Printers & scanners**. Select your product name and select **Manage** > **Printer properties**.
 - **Windows 8.x:** Navigate to the **Apps** screen and select **Control Panel** > **Hardware and Sound** > **Devices and Printers**. Right-click your product and select **Printer properties**.
 - **Windows 7:** Click  and select **Devices and Printers**. Right-click your product and select **Printer properties**.
 - **Windows Vista:** Click  and select **Control Panel**. Click **Printer** under **Hardware and Sound**, then right-click your product and select **Properties**.
2. Click the **Optional Settings** tab.

Note: You can prevent access to the **Optional Settings** tab by changing the user or group permissions in the **Security** tab.

3. Click **Driver Settings**.

You see this window:

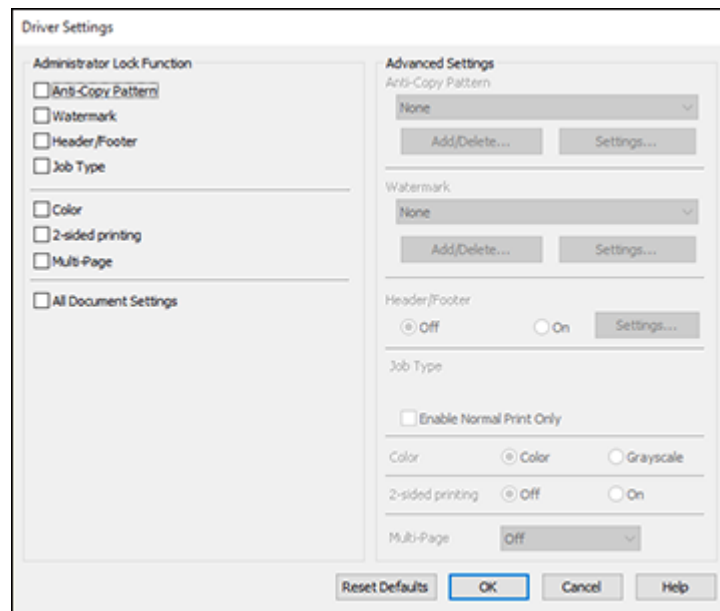

4. Select the checkbox for each setting you want to lock. To lock all print settings, select **All Document Settings**.
5. Under **Advanced Settings**, select the setting option you want to use for each locked setting.
6. Click **OK**.

[Locked Setting Options](#)

Parent topic: [Printing with the Standard Epson Printer Software - Windows](#)

Locked Setting Options

Select the options you want to use for any locked print settings.

Setting	Options	Description
Anti-Copy Pattern	Various data items	Lets you select the data to use for the pattern or prohibit anti-copy patterns
	Add/Delete	Lets you add or delete a customized anti-copy pattern
	Settings	Lets you select the arrangement, size, and other settings for the custom anti-copy pattern
Watermark	Various text watermarks	Lets you select the text for the watermark or prohibit watermarks
	Add/Delete	Lets you add or delete a customized text or image-based watermark
	Settings	Lets you select the size, position, and other watermark settings
Header/Footer	Off	Prohibits headers or footers
	On	Allows headers and footers
	Settings	Lets you select the text and position for printing headers and footers
Job Type	—	Lets you select the Enable Normal Print Only checkbox so only the Normal Print option is available
Color	Color	Allows color printing
	Grayscale	Allows printing in black or shades of gray only
2-sided printing	Off	Allows printing on one side of the paper only
	On	Allows printing on both sides of the paper



Setting	Options	Description
Multi-Page	Off	Prohibits multi-page settings
	2-Up	Allows printing of 2 pages on one sheet of paper
	4-Up	Allows printing of 4 pages on one sheet of paper
	6-Up	Allows printing of 6 pages on one sheet of paper
	8-Up	Allows printing of 8 pages on one sheet of paper
	9-Up	Allows printing of 9 pages on one sheet of paper
	16-Up	Allows printing of 16 pages on one sheet of paper
All Document Settings	—	Lets you lock all print settings

Parent topic: [Locking Printer Settings - Windows](#)

Entering a User ID and Password for Printing

If you enabled Access Control on the product, you must enter a user ID and password in the printer driver to be able to print.

Note: If you do not know the user ID or password, contact your administrator for assistance.

1. Access the Windows Desktop and right-click the  icon for your product in the right side of the Windows taskbar, or click the up arrow and right-click . Select **Printer Settings** and click the **Maintenance** tab.

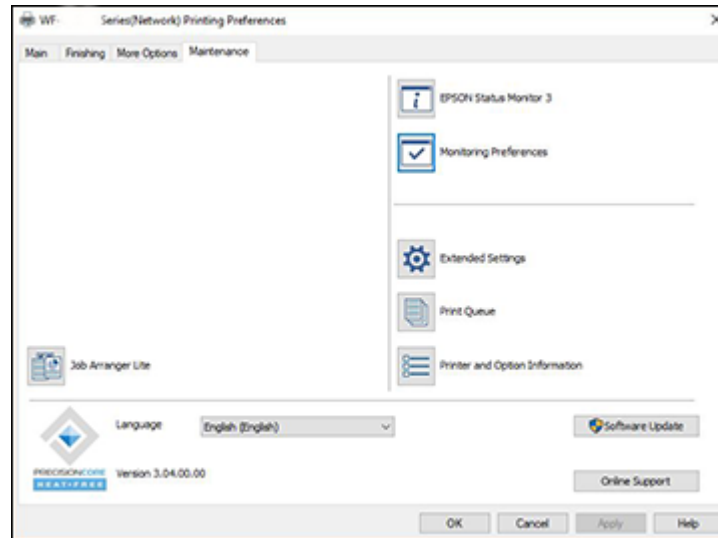



2. Click the **Printer and Option Information** button.
3. Select the **Save Access Control Settings** checkbox.
4. Click the **Settings** button.
5. Enter your user name and password.
6. Click **OK**.

Parent topic: [Printing with the Standard Epson Printer Software - Windows](#)

Selecting Default Print Settings - Windows

When you change your print settings in a program, the changes apply only while you are printing in that program session. If you want to change the print settings you use in all your Windows programs, you can select new default print settings.

1. Access the Windows Desktop and right-click the  icon for your product in the right side of the Windows taskbar, or click the up arrow and right-click .

2. Select **Printer Settings**.

You see the printer settings window:

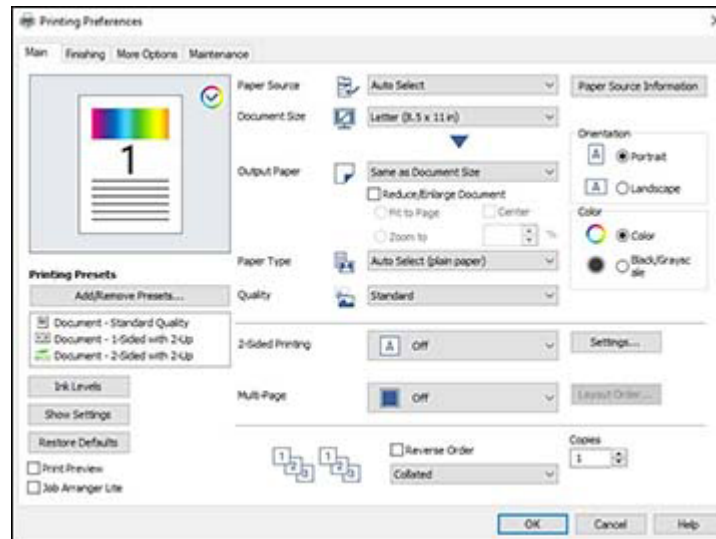

3. Select the print settings you want to use as defaults in all your Windows programs.

4. Click **OK**.



These settings are now the defaults selected for printing. You can still change them as needed for printing in any program session.

[Changing the Language of the Printer Software Screens](#)

Parent topic: [Printing with the Standard Epson Printer Software - Windows](#)

Changing the Language of the Printer Software Screens

You can change the language used on the Windows printer software screens.

1. Access the Windows Desktop and right-click the  icon for your product in the right side of the Windows taskbar, or click the up arrow and right-click .
2. Select **Printer Settings**.
You see the printer settings window.
3. Click the **Maintenance** tab.

You see the maintenance options:

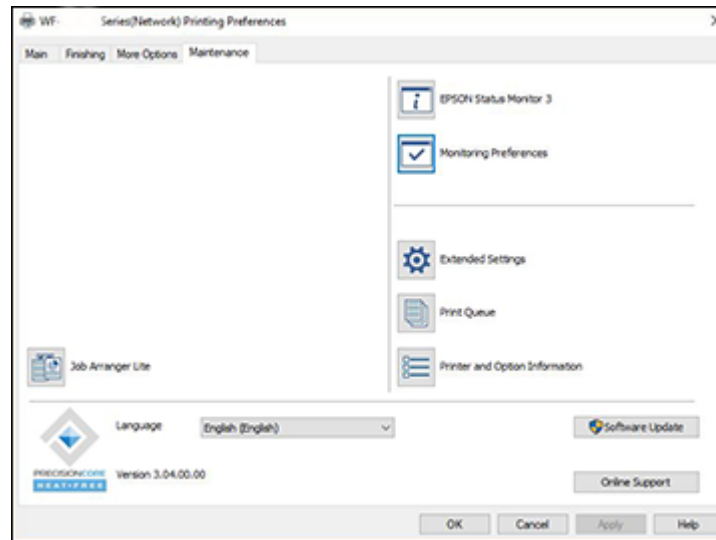



4. Select the language you want to use as the **Language** setting.
5. Click **OK** to close the printer software window.

The printer software screens appear in the language you selected the next time you access them.

Parent topic: [Selecting Default Print Settings - Windows](#)

Changing Automatic Update Options

Your printer software for Windows automatically checks for updates to the product software. You can change how often the software checks for updates or disable this feature.

1. Access the Windows Desktop and right-click the  icon for your product in the right side of the Windows taskbar, or click the up arrow and right-click .
2. Select **Software Update Settings**.

You see this window:

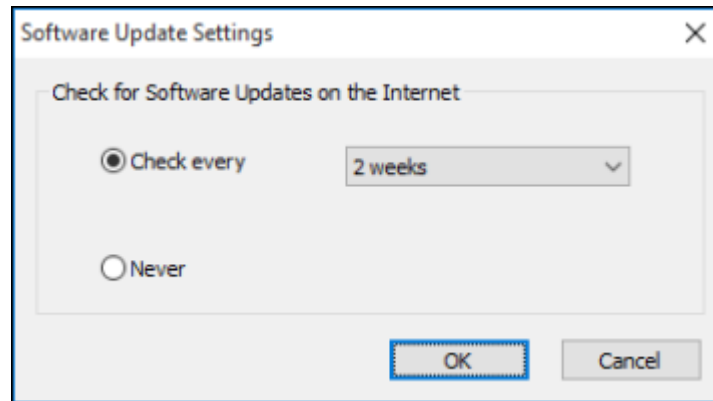

3. Do one of the following:
 - To change how often the software checks for updates, select a setting in the **Check every** menu.
 - To disable the automatic update feature, select the **Never** option.
4. Click **OK** to exit.

Note: If you choose to disable the automatic update feature, you can check for updates manually.

Parent topic: [Printing with the Standard Epson Printer Software - Windows](#)

Printing with the Epson Standard Printer Software - Mac

You can print with your product using any Mac printing program, as described in these sections.

Note: If you have an Internet connection, it is a good idea to check for updates to your product software on Epson's support website.

[Selecting Basic Print Settings - Mac](#)

[Selecting Page Setup Settings - Mac](#)

[Selecting Print Layout Options - Mac](#)

[Selecting Double-sided Printing Settings - Mac](#)

[Managing Color - Mac](#)

[Selecting Finishing Options - Mac](#)
[Selecting Printing Preferences - Mac](#)
[Printing Your Document - Mac](#)

Parent topic: [Printing from a Computer](#)

Selecting Basic Print Settings - Mac

Select the basic settings for the document or photo you want to print.

1. Open a photo or document for printing.
2. Select the print command in your application.

Note: You may need to select a print icon on your screen, the **Print** option in the File menu, or another command. See your application's help utility for details.

3. Select your product as the **Printer** setting.

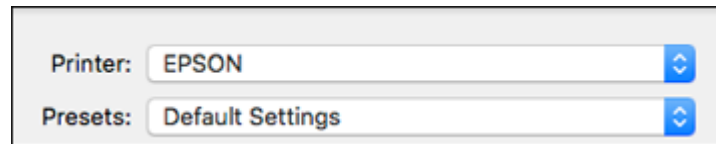

4. If necessary, click the arrow next to the Printer setting or the **Show Details** button to expand the print window.

You see an expanded printer settings window like this:

The screenshot shows a printer settings window with the following sections:

- Printer:** EPSON
- Presets:** None
- Copies:** 1
- Pages:**
 - All Pages
 - Range from 1 to 1
 - Selection
Select pages from the sidebar
- Paper Size:** US Letter 8.50 by 11.00 inches
- Orientation:** Portrait Landscape
- Scaling:** 100%
- > Notes:** Header and Footer: Off, Rewrap to fit page: On
- > Layout:** 1 page per sheet

Note: The print window and pop-up menu may look different, depending on the Mac OS version and the application you are using.

5. Select the **Copies** and **Pages** settings as necessary.

Note: If you do not see these settings in the print window, check for them in your application before printing.

6. Select the page setup options: **Paper Size** and **Orientation**.

Note: If you do not see these settings in the print window, check for them in your application before printing. They may be accessible by selecting **Page Setup** from the File menu.

7. Select any application-specific settings that appear on the screen, such as those shown in the image above for the Notes application.
8. Select **Print Settings**, **Printer Options**, or **Printer Features** depending on your OS version.

You see a menu like this:

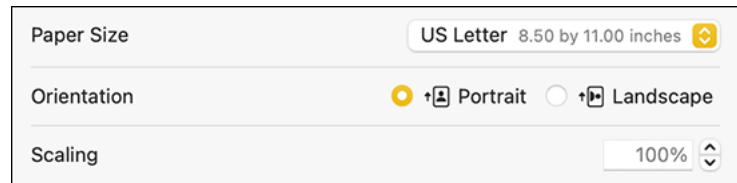

9. Select the **Paper Source** you wish to print from.
10. Select the type of paper you loaded as the **Media Type** setting.

Note: The setting may not exactly match the name of your paper. Check the paper type settings list for details.

11. Change the **Job Type** setting if you want to save the file to the product's hard drive.
12. Select any of the available print options.

[Paper Source Options - Mac](#)

Parent topic: [Printing with the Epson Standard Printer Software - Mac](#)

Related references

[Paper or Media Type Settings - Printing Software](#)

Paper Source Options - Mac

You can select any of the available options in the Paper Source menu to print on the paper loaded in that source.

Auto Select

Automatically selects the paper source based on the selected paper size.

Paper Tray

Selects the paper in the paper tray as the paper source.

Cassette 1

Selects the paper in cassette 1 as the paper source.

Cassette 2

Selects the paper in cassette 2 as the paper source.

Cassette 3

Selects the paper in cassette 3 as the paper source.

Cassette 4

Selects the paper in cassette 4 as the paper source.

High Capacity Tray

Selects the optional high capacity tray as the paper source if it is connected to the printer.

Parent topic: [Selecting Basic Print Settings - Mac](#)

Selecting Page Setup Settings - Mac

Depending on your application, you may be able to select the paper size and orientation settings from the print window.

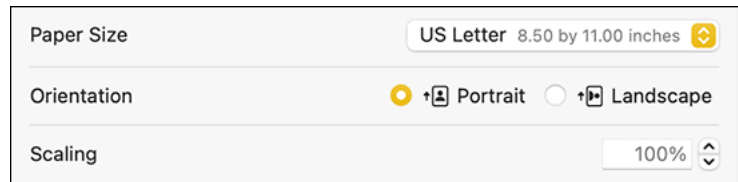

Note: If you do not see these settings in the print window, check for them in your application before printing. They may be accessible by selecting **Page Setup** from the File menu.

1. Select the size of the paper you loaded as the **Paper Size** setting.
2. Select the orientation of your document or photo as shown in the print window.

Note: If you are printing an envelope, select the  icon or **Landscape** setting.

Note: You can reduce or enlarge the size of the printed image by selecting **Paper Handling** from the pop-up menu and selecting a scaling option.

Parent topic: [Printing with the Epson Standard Printer Software - Mac](#)

Selecting Print Layout Options - Mac

You can select a variety of layout options for your document or photo by selecting **Layout** from the pop-up menu on the print window.

- To print multiple pages on one sheet of paper, select the number of pages in the **Pages per Sheet** pop-up menu. To arrange the print order of the pages, select a **Layout Direction** setting.
- To print borders around each page on the sheet, select a line setting from the **Border** pop-up menu.
- To invert or flip the printed image, select the **Reverse page orientation** or **Flip horizontally** settings.

Parent topic: [Printing with the Epson Standard Printer Software - Mac](#)

Selecting Double-sided Printing Settings - Mac

You can print on both sides of the paper by selecting **Two-sided Printing Settings** from the pop-up menu on the print window.

Note: For macOS 13 and later, select **Printer Options** then select **Two-sided Printing Settings**.

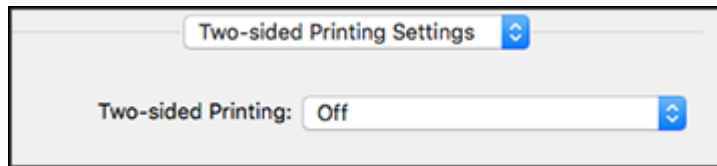

Note: Some options may be pre-selected or unavailable, depending on other settings you have chosen or if you are accessing the product over a network. This screen may be different, depending on the Mac OS version you are using.

1. Select one of the **Two-sided Printing** options.

2. Select the type of document you are printing as the **Document Type** setting. The software automatically sets the Adjustments options for that document type.

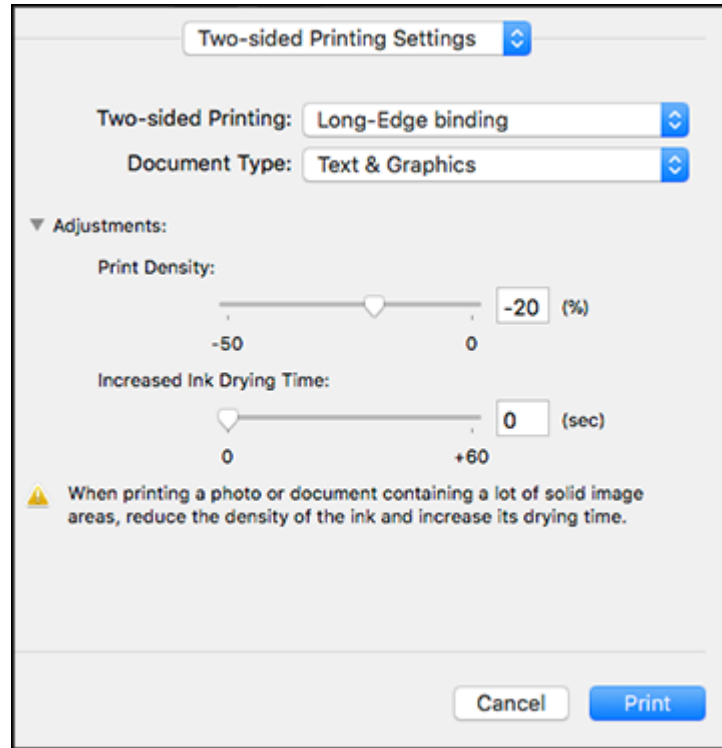

3. If necessary, customize the Adjustments settings as instructed on the screen.
4. Print a test copy of your double-sided document to test the selected settings.
5. Follow any instructions displayed on the screen during printing.

[Double-sided Printing Options and Adjustments - Mac](#)

Parent topic: [Printing with the Epson Standard Printer Software - Mac](#)

Double-sided Printing Options and Adjustments - Mac

You can select any of the available options in the **Two-sided Printing Settings** pop-up menu to set up your double-sided print job.

Long-Edge binding

Orients double-sided printed pages to be bound on the long edge of the paper.

Short-Edge binding

Orients double-sided printed pages to be bound on the short edge of the paper.

Parent topic: [Selecting Double-sided Printing Settings - Mac](#)

Managing Color - Mac

You can adjust the Color Matching and Color Options settings to fine-tune the colors in your printout or turn off color management in your printer software.

1. Select **Color Matching** from the pop-up menu in the print window.

Note: For macOS 13 and later, select **Printer Options** then select **Color Matching**.

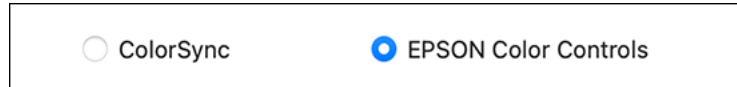

2. Select one of the available options.
3. Select **Color Options** from the pop-up menu in the print window.

Note: For macOS 13 and later, select **Printer Options** then select **Color Options**.

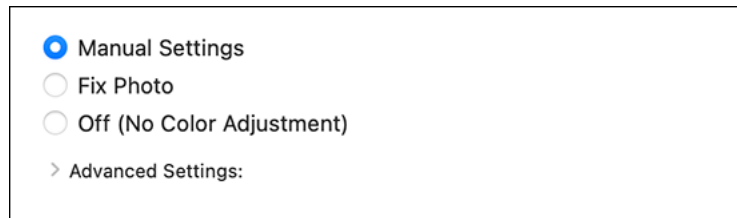

Note: The available settings on the Color Options menu depend on the option you selected on the Color Matching menu.

4. Select one of the available options.

[Color Matching and Color Options - Mac](#)

Parent topic: [Printing with the Epson Standard Printer Software - Mac](#)

Color Matching and Color Options - Mac

You can select these settings on the **Color Matching** and **Color Options** menus.

Color Matching Settings

EPSON Color Controls

Lets you manage color using controls in your printer driver or turn off color management.

ColorSync

Prints using standard color profiles for your product and paper to help match image colors. You can customize the conversion method and filter settings on the ColorSync pop-up menu in the print window.

Color Options Settings

Manual Settings

Lets you select manual color adjustments. Click the arrow next to **Advanced Settings** and select settings for **Brightness**, **Contrast**, **Saturation**, and individual color tones. You can also select a color **Mode** setting for printing photos and graphics and the **Fix Red-Eye** setting to reduce or remove red-eye in photos. Depending on the selected color mode, you can also adjust the midtone density using the **Gamma** setting.

Fix Photo

Improves the color, contrast, and sharpness of flawed photos. Click the arrow next to **Advanced Settings** and select the **Fix Red-Eye** setting to reduce or remove red-eye in photos.

Note: Fix Photo uses a sophisticated face recognition technology to optimize photos that include faces. For this to work, both eyes and the nose must be visible in the subject's face. If your photo includes a face with an intentional color cast, such as a statue, you may want to turn off **Fix Photo** to retain the special color effects.

Parent topic: [Managing Color - Mac](#)

Selecting Finishing Options - Mac

You can choose finishing options by selecting **Finishing** from the pop-up menu on the print window.

Note: For macOS 13 and later, select **Printer Options** then select **Finishing**.

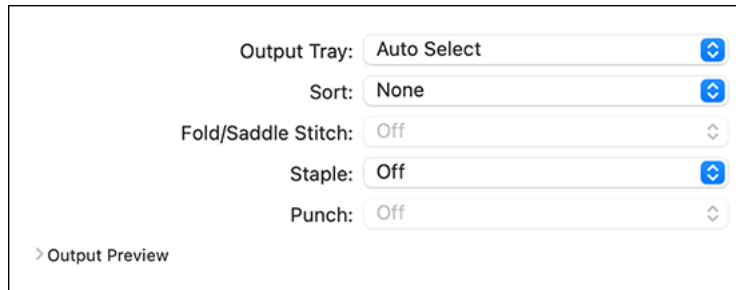

1. Select the **Output Tray** you want to output your print jobs to.
2. If you are printing multiple copies, select a **Sort** option.
3. If optional finisher and punch units are installed, you can choose the following options:
 - Select a **Fold/Saddle Stitch** option to choose the booklet settings.
 - Select a **Staple** option to choose the staple location on the document.
 - Select a **Punch** option to choose where the holes are punched.

[Finishing Options - Mac](#)

Parent topic: [Printing with the Epson Standard Printer Software - Mac](#)

Finishing Options - Mac

You can select any of the available options in the **Finishing** pop-up menu.

Output Tray

Select where printed jobs are output.

Sort

Select how to sort print jobs with multiple copies.

Fold/Saddle Stitch

Select binding settings for folded or folded and saddle stitched printed documents.

Staple

Select the staple location for printed documents.

Punch

Select the hole punch location for printed documents.

Note: The **Staple**, **Fold/Saddle Stitch**, and **Punch** options are available only when the necessary optional equipment is installed.

Parent topic: [Selecting Finishing Options - Mac](#)

Related references

[Optional Accessories and Replacement Parts](#)

Selecting Printing Preferences - Mac

You can select printing preferences that apply to all the print jobs you send to your product.

1. In the Apple menu or the Dock, select **System Preferences** or **System Settings**.
2. Select **Print & Fax**, **Print & Scan**, or **Printers & Scanners**, select your product, and select **Options & Supplies**.
3. Select **Driver** or **Options**.

You see a screen like this:

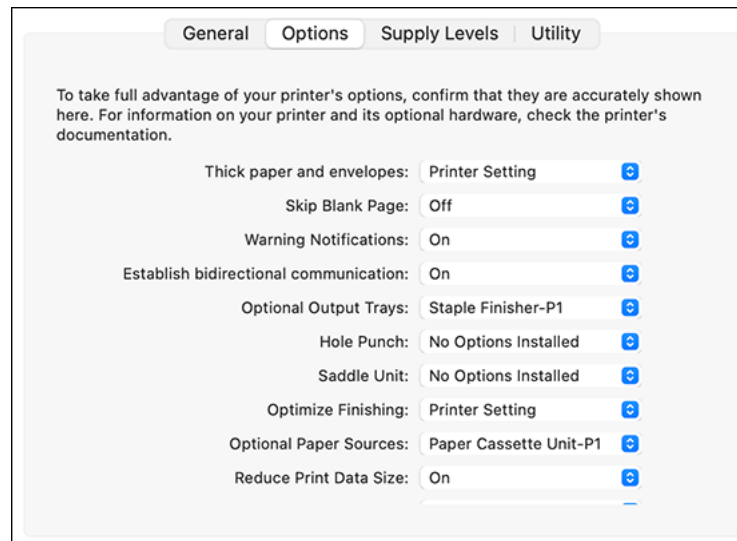

Note: The available settings and appearance of the options window may be different than those covered here, depending on the Mac OS version and the application you are using.

4. Select any of the available printing preferences.
5. Click **OK**.

[Printing Preferences - Mac](#)

Parent topic: [Printing with the Epson Standard Printer Software - Mac](#)

Printing Preferences - Mac

You can select these settings on the **Options** or **Driver** tab.

Note: Some settings are available only if the necessary options are installed.

Thick Paper and Envelopes

Prevents ink from smearing when you print on envelopes or other thick paper.

Skip Blank Page

Ensures that your product does not print pages that contain no text or images.

Warning Notifications

Lets you choose whether or not to receive warning notifications from the printer software for various operating conditions.

Establish bidirectional communication

Allows the product to communicate with the computer. Do not change the default setting unless you experience issues when using a shared printing pool.

Reduce Print Data Size

Increases print data compression to improve print speed. Not recommended when printing fine patterns.

Optional Output Trays

Select an output tray option if the optional finisher unit is installed.

Optional Paper Sources

Select an optional paper source option if the optional high-capacity input tray is installed.

Hole Punch

Select a hole punch setting.

Saddle Unit

Specifies whether the saddle unit is present.

Optimize Finishing

Reduces paper misalignment to improve stapling and stacking printouts. Print speed is decreased.

High-compression data mode

Compresses print data, which may improve print speed, especially when printing multi-page documents.

Parent topic: [Selecting Printing Preferences - Mac](#)

Printing Your Document - Mac

Once you have selected your print settings, you are ready to print.

Click **Print** at the bottom of the print window.

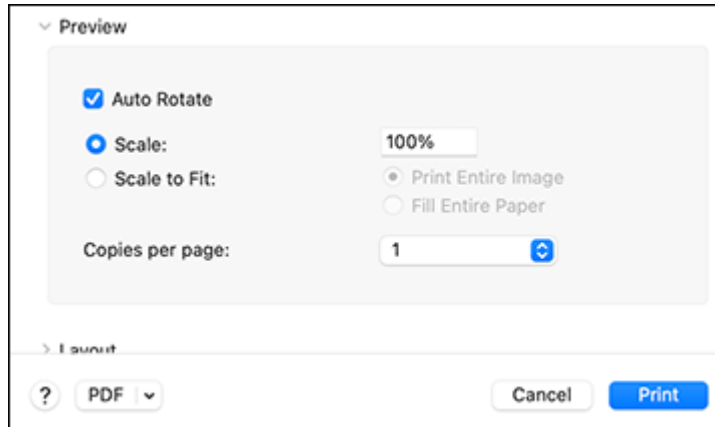

[Checking Print Status - Mac](#)

Parent topic: [Printing with the Epson Standard Printer Software - Mac](#)

Checking Print Status - Mac



During printing, you can view the progress of your print job, control printing, and check ink status.

1. Click the printer icon when it appears in the Dock.

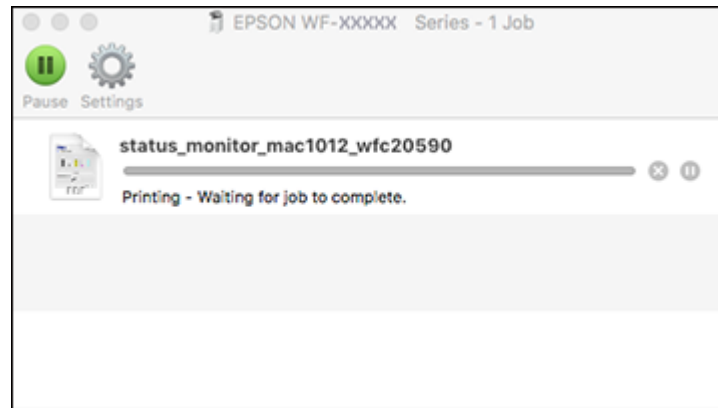
You see the print status window:



2. Select the following options as necessary for your Mac OS version:

- To cancel printing, click the print job and click  or **Delete**.
- To pause a print job, click the print job and click  or **Hold**. To resume a print job, click the paused print job and click  or **Resume**.
- To pause printing for all queued print jobs, click **Pause** or **Pause Printer**.
- To display other printer information, click **Settings** or **Supply Levels**.

Parent topic: [Printing Your Document - Mac](#)

Printing with the Epson Universal Print Driver - Windows

You can print with the Epson Universal Print Driver using any Windows printing program, as described in these sections.

[Synchronizing Printer Settings - Epson Universal Print Driver - Windows](#)

[Selecting Print Settings - Epson Universal Print Driver - Windows](#)

[Selecting Default Print Settings - Epson Universal Print Driver - Windows](#)

[Locking Printer Settings - Epson Universal Print Driver - Windows](#)





[Adding Network Printers - Epson Universal Print Driver - Windows](#)

Parent topic: [Printing from a Computer](#)

Synchronizing Printer Settings - Epson Universal Print Driver - Windows

You may need to synchronize the printer driver with the product if the printer driver does not detect the correct information or settings from the product.

Note: You must sync the printer driver before you can use any optional equipment installed on the product.

1. Do one of the following:
 - **Windows 11:** Click  and select **Settings > Bluetooth & devices > Printers & scanners**. Select **EPSON Universal Print Driver** and select **Printer properties**.
 - **Windows 10:** Click  and select  (Settings) > **Devices > Printers & scanners**. Select **EPSON Universal Print Driver** and select **Manage > Printer properties**.
 - **Windows 8.x:** Navigate to the **Apps** screen and select **Control Panel > Hardware and Sound > Devices and Printers**. Right-click **EPSON Universal Print Driver** and select **Printer properties**.
 - **Windows 7:** Click  and select **Devices and Printers**. Right-click **EPSON Universal Print Driver** and select **Printer properties**.
 - **Windows Vista:** Click  and select **Control Panel**. Click **Printer** under **Hardware and Sound**, then right-click **EPSON Universal Print Driver** and select **Properties**.
2. Click the **Optional Settings** tab.

You see a window like this:

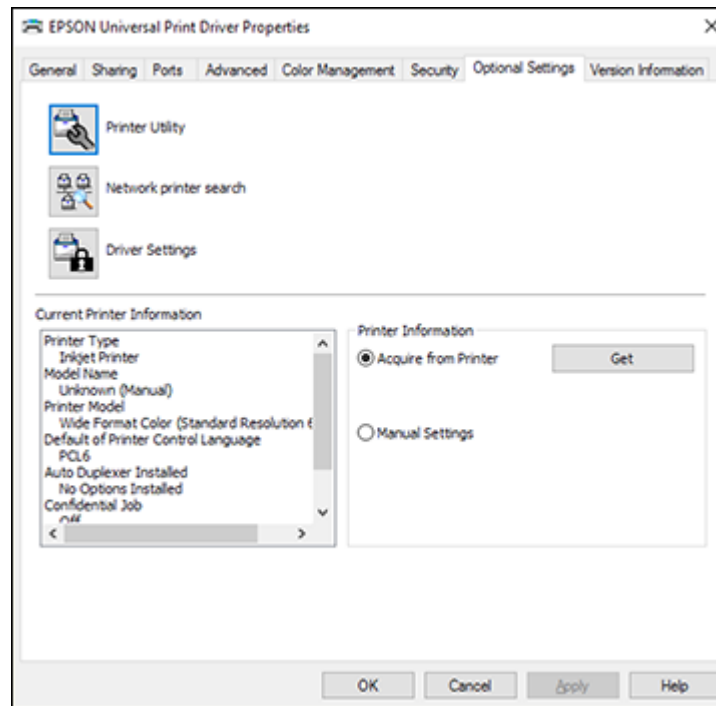

3. Make sure **Acquire from Printer** is selected and click **Get**.

Note: Select the **Only Optional Information** checkbox if you only want to enable any optional equipment installed on the product.

The product's settings and other information appears in the Current Printer Information area.

4. Click **OK**.

Parent topic: [Printing with the Epson Universal Print Driver - Windows](#)

Selecting Print Settings - Epson Universal Print Driver - Windows

Select the basic settings for the document or photo you want to print.

Note: The names of settings on the universal print driver screens may vary slightly, depending on the version of the print driver you have installed.

1. Open a photo or document for printing.
2. Select the print command in your application.

Note: You may need to select a print icon on your screen, the **Print** option in the **File** menu, or another command. See your application's help utility for details.

3. If necessary, select **EPSON Universal Print Driver** as the printer you want to use.

Note: You may also need to select **Properties** or **Preferences** to view your print settings.

You see the **Main** tab of your printer settings window:

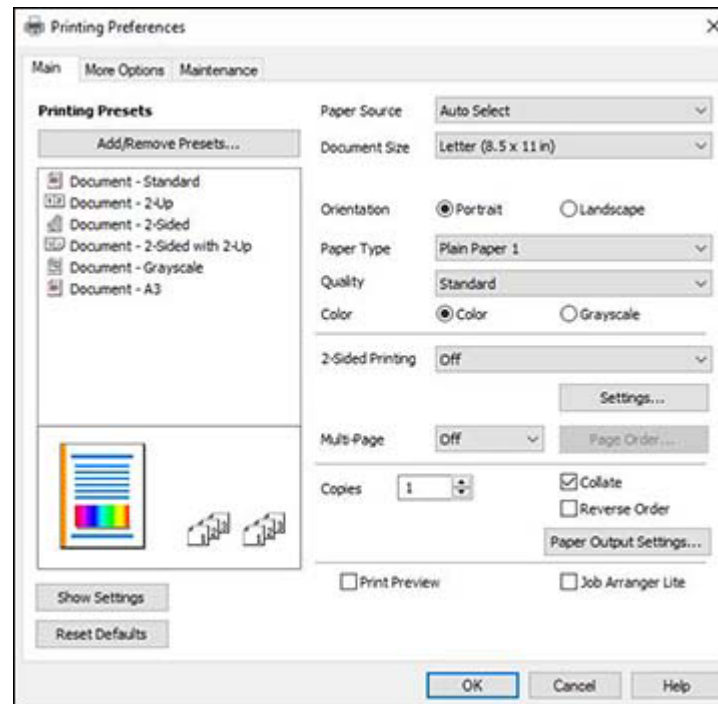

Note: For more information about a setting, right-click it and select **Help**.

4. For the **Paper Source** setting, select where you loaded the paper you want to print on.
5. Select the size of the paper you loaded as the **Document Size** setting.

Note: You can also select the **User-Defined** setting to create a custom paper size.

6. Select the orientation of your document.

Note: If you are printing an envelope, select **Landscape**.

7. Select the type of paper you loaded as the **Paper Type** setting.



Note: The setting may not exactly match the name of your paper. Check the paper type settings list for details.

8. Select any of the available print options.
9. To select a variety of additional layout and printing options for your document or photo, select the **More Options** tab and select the printing options you want.
10. To select maintenance and other optional settings, select the **Maintenance** tab and select the options you want.

Parent topic: [Printing with the Epson Universal Print Driver - Windows](#)

Selecting Default Print Settings - Epson Universal Print Driver - Windows

When you change your print settings in a program, the changes apply only while you are printing in that program session. If you want to change the print settings you use in all your Windows programs, you can select new default print settings.

1. Do one of the following:
 - **Windows 11:** Click  and select **Settings > Bluetooth & devices > Printers & scanners**. Select **EPSON Universal Print Driver** and select **Printer properties**.
 - **Windows 10:** Click  and select  (Settings) > **Devices > Printers & scanners**. Select **EPSON Universal Print Driver** and select **Manage > Printing Preferences**.
 - **Windows 8.x:** Navigate to the **Apps** screen and select **Control Panel > Hardware and Sound > Devices and Printers**. Right-click **EPSON Universal Print Driver** and select **Print Preferences**.

- **Windows 7:** Click  and select **Devices and Printers**. Right-click **EPSON Universal Print Driver** and select **Printing Preferences**.

You see the printer settings window:

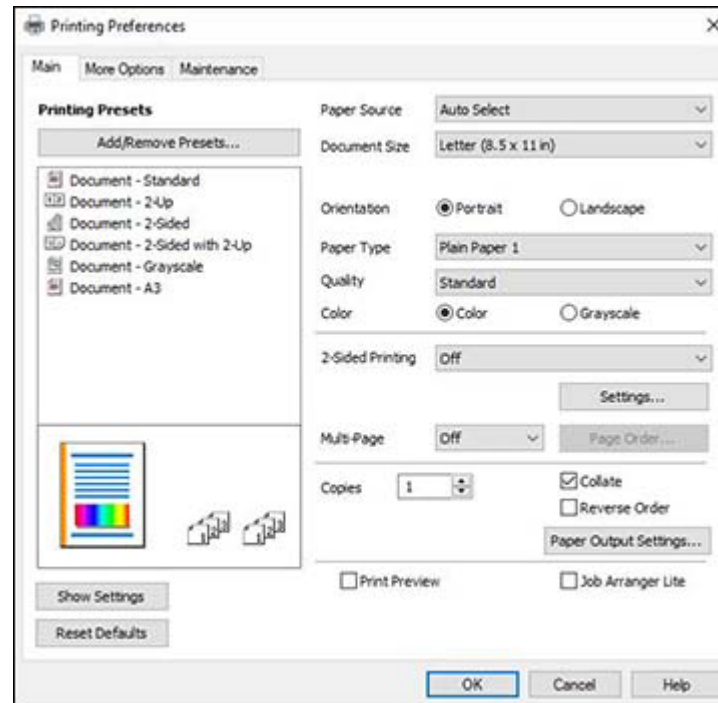

Note: For more information about a setting, right-click it and select **Help**.





2. Select the print settings you want to use as defaults in all your Windows programs.
3. Click **OK**.

These settings are now the defaults selected for printing. You can still change them as needed for printing in any program session.

Parent topic: [Printing with the Epson Universal Print Driver - Windows](#)

Locking Printer Settings - Epson Universal Print Driver - Windows

Administrators can lock some printer settings to prevent unauthorized changes.

1. Do one of the following:
 - **Windows 11:** Click  and select **Settings > Bluetooth & devices > Printers & scanners**. Select **EPSON Universal Print Driver** and select **Printer properties**.
 - **Windows 10:** Click  and select  (Settings) > **Devices > Printers & scanners**. Select **EPSON Universal Print Driver** and select **Manage > Printer properties**.
 - **Windows 8.x:** Navigate to the **Apps** screen and select **Control Panel > Hardware and Sound > Devices and Printers**. Right-click **EPSON Universal Print Driver** and select **Printer properties**.
 - **Windows 7:** Click  and select **Devices and Printers**. Right-click **EPSON Universal Print Driver** and select **Printer properties**.
 - **Windows Vista:** Click  and select **Control Panel**. Click **Printer** under **Hardware and Sound**, then right-click **EPSON Universal Print Driver** and select **Properties**.
2. Click the **Optional Settings** tab.
3. Click **Driver Settings**.

You see this window:

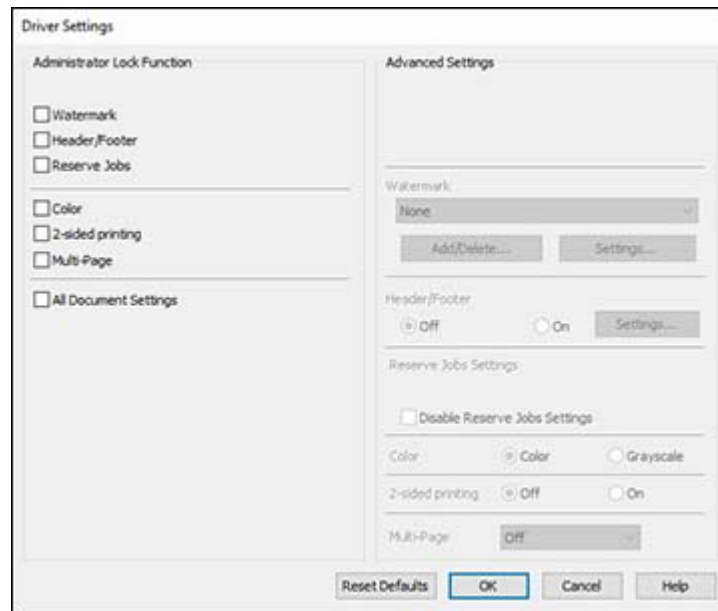

4. Select the checkbox for the settings you want to lock. To lock all print settings, select **All Document Settings**.
5. Under **Advanced Settings**, select the setting option you want to use for each locked setting.
6. Click **OK**.

[Epson Universal Print Driver Locked Setting Options](#)

Parent topic: [Printing with the Epson Universal Print Driver - Windows](#)

Epson Universal Print Driver Locked Setting Options

Select the options you want to use for any locked print settings.





Setting	Options	Description
Watermark	Various text watermarks	Lets you select the text for the watermark or prohibit watermarks
	Add/Delete	Lets you add or delete a customized text or image-based watermark
	Settings	Lets you select the size, position, and other watermark settings
Header/Footer	Off	Prohibits headers or footers
	On	Allows headers and footers
	Settings	Lets you select the text and position for printing headers and footers
2-sided printing	Off	Allows printing on only one side of the paper
	On	Allows printing on both sides of the paper

Parent topic: [Locking Printer Settings - Epson Universal Print Driver - Windows](#)

Adding Network Printers - Epson Universal Print Driver - Windows

You can use the Epson Universal Print Driver to find and add network printers.

1. Do one of the following:
 - **Windows 11:** Click  and select **Settings > Bluetooth & devices > Printers & scanners**. Select **EPSON Universal Print Driver** and select **Printer properties**.

- **Windows 10:** Click  and select  (Settings) > **Devices > Printers & scanners**. Select **EPSON Universal Print Driver** and select **Manage > Printer properties**.
- **Windows 8.x:** Navigate to the **Apps** screen and select **Control Panel > Hardware and Sound > Devices and Printers**. Right-click **EPSON Universal Print Driver** and select **Printer properties**.
- **Windows 7:** Click  and select **Devices and Printers**. Right-click **EPSON Universal Print Driver** and select **Printer properties**.
- **Windows Vista:** Click  and select **Control Panel**. Click **Printer** under **Hardware and Sound**, then right-click **EPSON Universal Print Driver** and select **Properties**.

2. Click the **Optional Settings** tab.

You see this window:

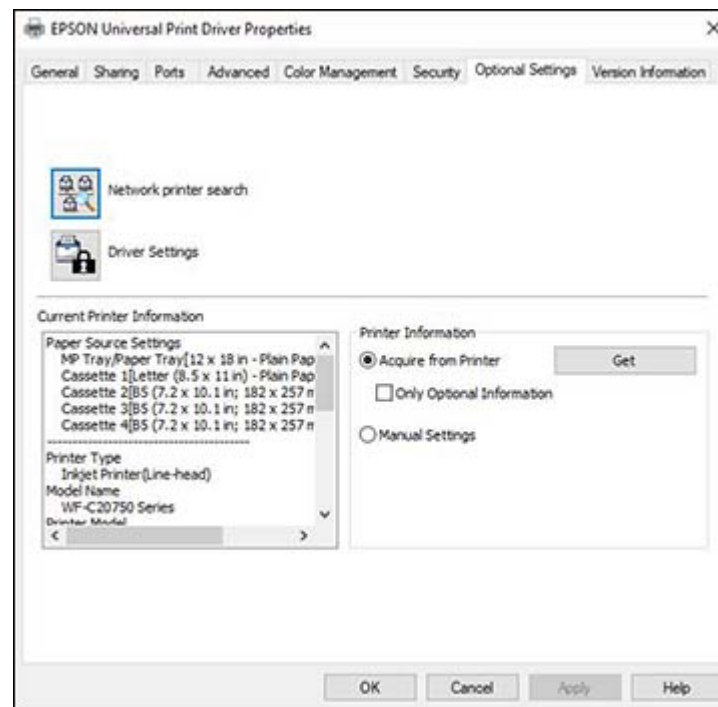

3. Click **Network printer search**.
4. When you see the search results, select **Add found printers**.

You see a screen like this:

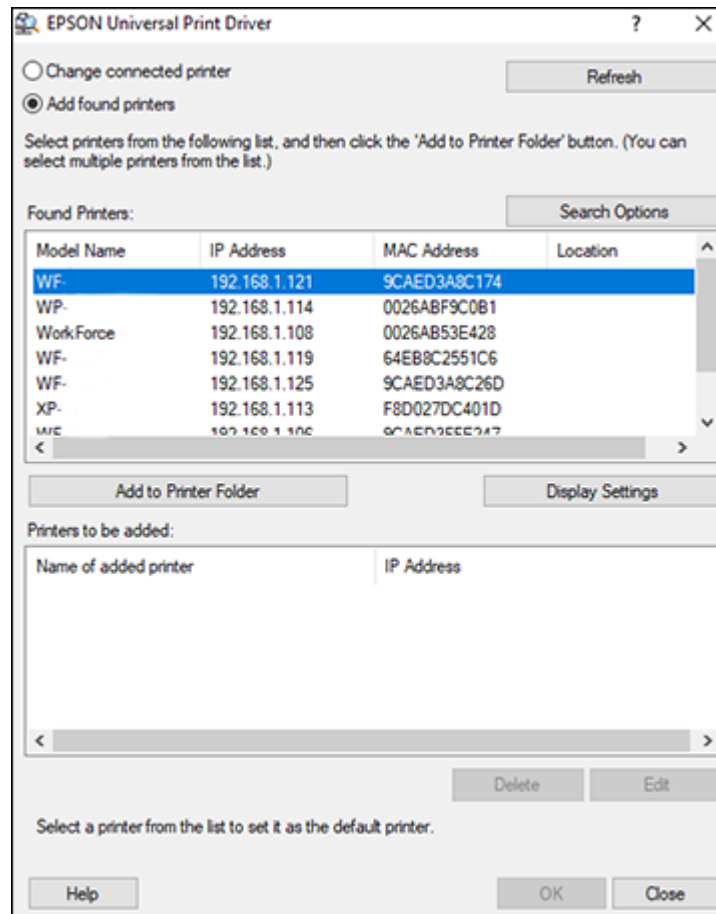

5. Select the printer or printers you want to add.
6. Click **Add to Printer Folder**.
The selected printer or printers appear in the lower section of the screen.
7. Select the checkbox next to the product you want to make your default printer, if necessary.
8. Click **OK**.

Parent topic: [Printing with the Epson Universal Print Driver - Windows](#)

Printing with the PostScript (PS3) Printer Software - Windows

You can print with the PostScript (PS3) printer software using any Windows printing program, as described in these sections.

Note: The PostScript printer software supports products that are connected via Ethernet. If your product is connected via USB, you will need to install the standard Epson printer software. To download the standard Epson printer software, visit epson.com/support (U.S.), epson.ca/support (Canada), or latin.epson.com/support (Latin America) and select your product.

[Selecting Basic Print Settings - PostScript Printer Software - Windows](#)

[Selecting Default Print Settings - PostScript Printer Software - Windows](#)

Parent topic: [Printing from a Computer](#)

Selecting Basic Print Settings - PostScript Printer Software - Windows

Select the basic settings for the document or photo you want to print.

The PostScript printer software supports plain paper printing on these paper and envelope sizes:

- A4 (8.3 × 11.7 inches [210 × 297 mm])
- Letter (8.5 × 11 inches [216 × 279 mm])
- Legal (8.5 × 14 inches [216 × 356 mm])
- 17 × 22 inches (432 × 559 mm)
- A3 (11.7 × 16.5 inches [297 × 420 mm])
- A3+ (13 × 19 inches [329 × 483 mm])
- A6 (4.1 × 5.8 inches [105 × 148 mm])
- B6 (5 × 7.2 inches [128 × 182 mm])
- A5 (5.8 × 8.2 inches [148 × 210 mm])
- 8 × 10 inches (203 × 254 mm)
- 8.5 × 13 inches (216 × 330 mm)
- 11 × 17 inches (279 × 432 mm)
- 12 × 18 inches (305 × 457 mm)
- SRA3 (12.6 × 17.7 inches [320 × 450 mm])
- Executive (7.25 × 10.5 inches [184 × 267 mm])

- Half Letter (5.5 × 8.5 inches [140 × 216 mm])
- Mexico-Oficio (8.5 × 13.4 inches [216 × 340 mm])
- Oficio 9 (8.46 × 12.4 inches [215 × 315 mm])
- No. 10 (4.1 × 9.5 inches [105 × 241 mm])

1. Open a photo or document for printing.
2. Select the print command in your application.

Note: You may need to select a print icon on your screen, the **Print** option in the **File** menu, or another command. See your application's help utility for details.

3. If necessary, select your product name as the printer you want to use, and then click the **Preferences** button.

You see this window:

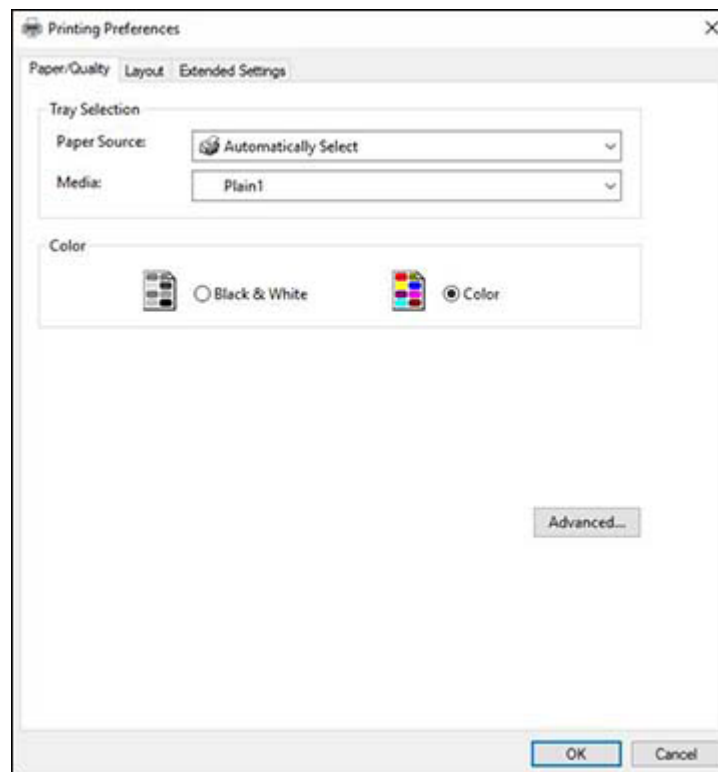

4. Select the **Paper Source** that matches where you loaded the paper you want to print on.
5. Select the paper type as the **Media** setting.
6. Select one of the following as the Color setting:
 - To print text and graphics in black only, select the **Black & White** setting.
 - To print a color document or photo, select the **Color** setting.
7. To select additional layout and printing options, select **Advanced** and select additional settings as necessary.

Note: You can select staple, fold, sort, and saddle stitch options from **Document Options > Printer Features**.

8. Click the **Layout** tab.

You see this window:

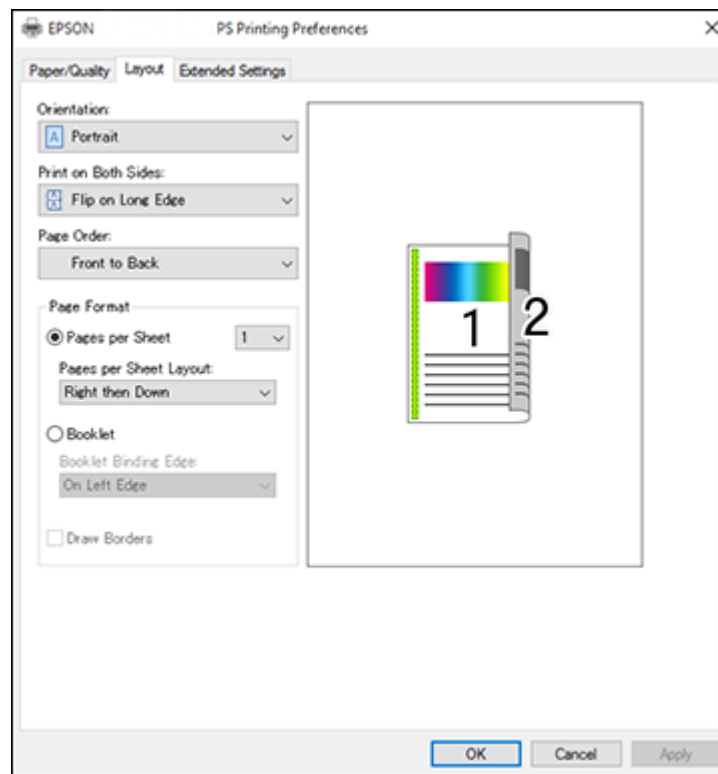





9. Select the print options as necessary.
10. Click **OK** when you are finished.

Parent topic: [Printing with the PostScript \(PS3\) Printer Software - Windows](#)

Selecting Default Print Settings - PostScript Printer Software - Windows

When you change your print settings in a program, the changes apply only while you are printing in that program session. If you want to change the print settings you use in all your Windows programs, you can select new default print settings.

1. Do one of the following:
 - **Windows 11:** Click , search for **Settings** and select it. Select **Bluetooth & devices > Printers & scanners**. Right-click on your product and select **Printer properties**.
 - **Windows 10:** Click  and select  (Settings) > **Devices > Printers & scanners**. Select your product name and select **Manage > Printing preferences**.
 - **Windows 8.x:** Navigate to the **Apps** screen and select **Control Panel > Hardware and Sound > Devices and Printers**. Right-click your product name and select **Print Preferences**.
 - **Windows 7:** Click  and select **Devices and Printers**. Right-click your product name and select **Printing Preferences**.

You see the printer settings window:

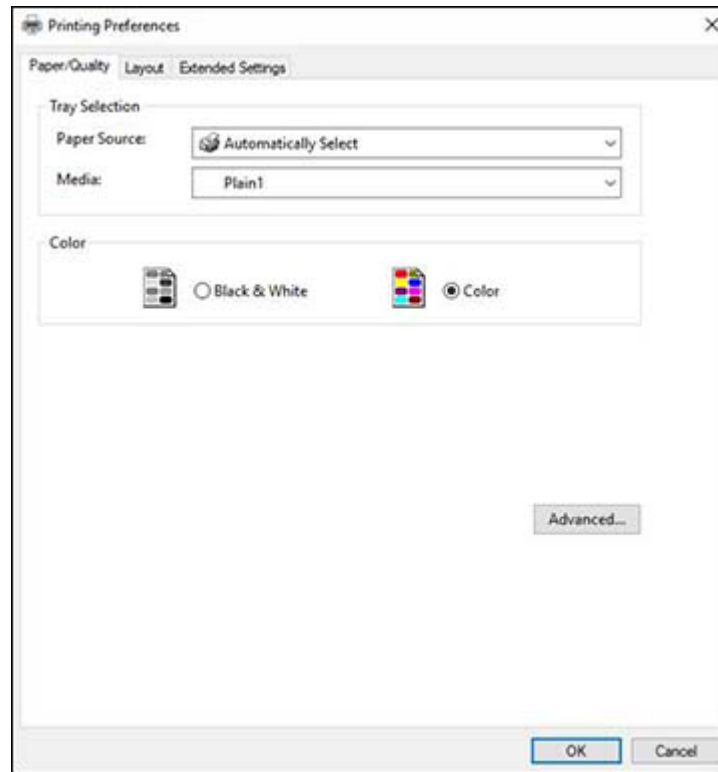

2. Select the print settings you want to use as defaults in all your Windows programs.
3. Click **OK**.

These settings are now the defaults selected for printing. You can still change them as needed for printing in any program session.

Parent topic: [Printing with the PostScript \(PS3\) Printer Software - Windows](#)

Printing with the PostScript (PS3) Printer Software - Mac

You can print with the PostScript (PS3) printer software using any Mac printing program, as described in these sections.

Note: The PostScript printer software supports products that are connected via Ethernet. If your product is connected via USB, you will need to install the standard Epson printer software. To download the standard Epson printer software, visit epson.com/support (U.S.), epson.ca/support (Canada), or latin.epson.com/support (Latin America) and select your product.

[Selecting Basic Print Settings - PostScript Printer Software - Mac](#)

Parent topic: [Printing from a Computer](#)

Selecting Basic Print Settings - PostScript Printer Software - Mac

Select the basic settings for the document or photo you want to print.

The PostScript printer software supports plain paper printing on these paper and envelope sizes:

- A4 (8.3 × 11.7 inches [210 × 297 mm])
 - Letter (8.5 × 11 inches [216 × 279 mm])
 - No. 10 (4.1 × 9.5 inches [105 × 241 mm])
 - A5 (5.8 × 8.2 inches [148 × 210 mm])
 - B5 (7.2 × 10.1 inches [182 × 257 mm])
 - A6 (4.1 × 5.8 inches [105 × 148 mm])
 - B6 (5 × 7.2 inches [128 × 182 mm])
 - Executive (7.25 × 10.5 inches [184 × 267 mm])
 - Legal (8.5 × 14 inches [216 × 356 mm])
 - 8.5 × 13 inches (216 × 330 mm)
 - A3 (11.7 × 16.5 inches [297 × 420 mm])
 - 11 × 17 inches (279 × 432 mm)
 - B4 (13.9 × 9.84 inches [353 × 250 mm])
1. Open a photo or document for printing.
 2. Select the print command in your application.

Note: You may need to select a print icon on your screen, the **Print** option in the **File** menu, or another command. See your application's help utility for details.

3. Select your product as the **Printer** setting.

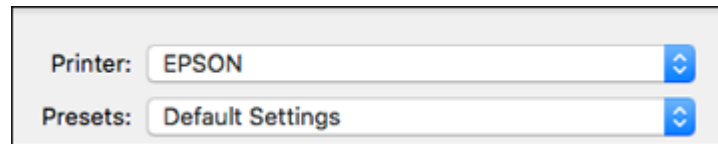

Printer: EPSON

Presets: Default Settings

4. If necessary, click the arrow next to the Printer setting or the **Show Details** button to expand the print window.

You see the expanded printer settings window for your product:

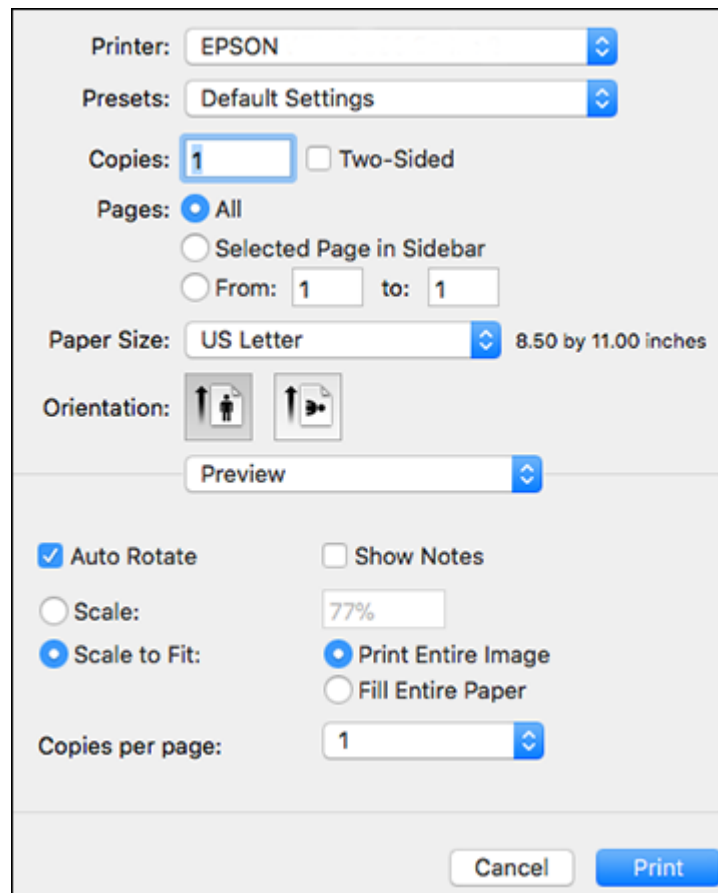

Printer: EPSON

Presets: Default Settings

Copies: 1 Two-Sided

Pages: All
 Selected Page in Sidebar
 From: 1 to: 1

Paper Size: US Letter 8.50 by 11.00 inches

Orientation: Portrait Landscape

Preview

Auto Rotate Show Notes

Scale: 77%

Scale to Fit: Print Entire Image
 Fill Entire Paper

Copies per page: 1

Cancel Print

Note: The print window may look different, depending on the Mac OS version and the application you are using.

5. Select the page setup options: **Paper Size** and **Orientation**.

Note: If you do not see these settings in the print window, check for them in your application before printing. They may be accessible by selecting **Page Setup** from the File menu.

6. Select any application-specific settings that appear on the screen, such as those shown in the image above for the Preview application.
7. Select **Paper Feed** from the pop-up menu.

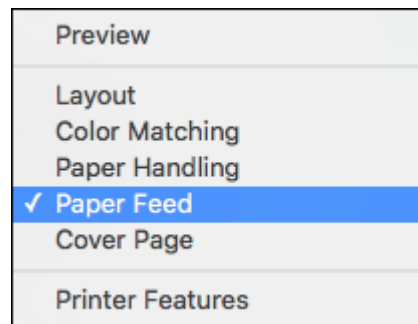

You see these settings:

8. Select **All Pages From** or **First Page From** and select the paper source you want to print from.
9. Select **Printer Features** from the pop-up menu.

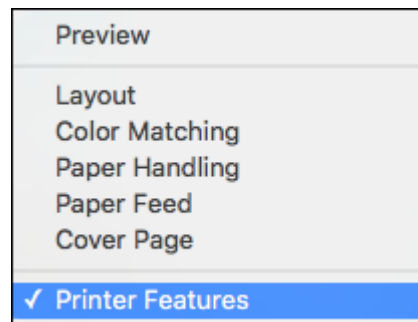

You see these settings:

10. Select any of the following from the pop-up menu as necessary:
 - Select **Layout** to adjust a variety of layout options for your document or photo.
 - Select **Paper Handling** to adjust the size of the image as you print it.
 - Select **Color Matching** to fine-tune the colors in your printout. For monochrome printers, this adjusts the tone and brightness of your printout.

Parent topic: [Printing with the PostScript \(PS3\) Printer Software - Mac](#)

Printing from a Smartphone or Tablet

You can print from a smartphone or tablet running iOS or Android using the Epson Smart Panel app.

Note: Your device must be connected to the same wireless network as your Epson product, and Epson Smart Panel must be configured for use with your product.

1. Download the Epson Smart Panel app from your device's app store or from Epson's website.
2. Open the Epson Smart Panel app and select a print menu on the home screen.
3. Follow the on-screen instructions to begin printing.

Parent topic: [Printing from a Computer](#)

Cancelling Printing Using the Product Control Panel

If you need to cancel printing, select **Stop** on the LCD screen, then select **Job List**. Select the job you want to cancel and select **Delete**, then select **Yes** to confirm.

Parent topic: [Printing from a Computer](#)

Scanning

You can scan your originals and save them as digital files.

[Starting a Scan](#)

[Scanning with Document Capture Pro or Document Capture](#)

[Scanning in Epson Scan 2](#)

[Scanning Special Projects](#)

[Entering a User ID and Password for Scanning](#)

Starting a Scan

After placing your originals on your product for scanning, start scanning using one of these methods.

[Starting a Scan Using the Product Control Panel](#)

[Setting Up and Scanning to a Network Folder or FTP Server](#)

[Starting a Scan Using the Epson Scan 2 Icon](#)

[Starting a Scan from a Scanning Program](#)

[Starting a Scan from a Smartphone or Tablet](#)

Parent topic: [Scanning](#)

Starting a Scan Using the Product Control Panel

You can scan an image to a variety of destinations using your product's control panel.

1. Make sure you installed the product software and connected the product to your computer or network.

Note: Restart your computer after installing the product software to enable scanning from the control panel.

2. Place your original on the product for scanning.

Note: To scan a double-sided or multi-page document, place your originals in the ADF.

3. Press the  home button, if necessary.
4. Select **Scan**.

5. Select one of the following **Scan** options:
 - **To Network Folder/FTP** saves your scanned file to a specified folder on a network.
 - **To Email** lets you send scanned files through a pre-configured email server.
 - **To Computer** lets you scan to a connected computer using Document Capture Pro (Windows) or Document Capture (Mac).
 - **To Memory Device** saves your scanned file on a USB device and lets you select the file format, quality, and other settings.
 - **To Cloud** sends your scanned files to a destination that you have registered with Epson Connect.
 - **To Storage** saves your scanned file to a specified folder in the product's hard drive.
 - **To WSD** lets you manage network scanning in Windows 11, Windows 10, Windows 8.x, or Windows 7. To use this feature, you must first set up a WSD (Web Services for Devices) port on your Windows 7 computer (the port is set up automatically on Windows 10 and Windows 8.x).
6. Follow the instructions in the links below to complete your scan.

[Scanning to Email](#)

[Scanning to a Memory Device](#)

[Scanning to the Cloud](#)

[Scanning to the Product's Hard Drive](#)

[Scanning to a Connected Computer](#)

[Setting Up a WSD Port \(Windows 7\)](#)

[Control Panel Scanning Options](#)

Parent topic: [Starting a Scan](#)

Scanning to Email

You can scan an original and email the scanned file using your product's control panel. You need to have a preconfigured email server before you can scan to email. You can enter email addresses directly on the product's control panel or select them from the **Recipient** tab. Make sure the date and time are set correctly so the time stamps on your emails are accurate.

1. Place your original on the product for scanning.

Note: To scan a double-sided or multi-page document, place all of the pages in the ADF.

2. Press the  home button, if necessary.
3. Select **Scan > To Email**.

4. Do one of the following:
 - Select an email address from any of the displayed frequent contacts.
 - Select **Keyboard** to use the on-screen keyboard to enter the email address for the recipient(s) and select **OK**.
 - Select **Recipient** and choose an email address from the list.
 - Select the  icon on the **Frequent** tab to choose an email address from your recent scan history.
5. Select **Scan Settings**.
6. Select **File Format** to choose the file format for your scan.
7. Scroll down to change the **Subject** and **File Name**, if necessary.
8. Select any additional scan settings as necessary.

Note: Select  to reset all scan settings to their default.

Note: To save the scanned image to the product's hard drive, select **File Storing** and enable the **File Storing** setting. Change any of the displayed settings as needed.

9. Select  to save your scan settings as a preset.

Note: Presets can be locked by an administrator. If you cannot access or change this setting, contact your administrator for assistance.

10. Select the **Send** icon.

Your product scans your original and emails the scanned file.

Parent topic: [Starting a Scan Using the Product Control Panel](#)

Related topics

[Using an Email Server](#)

Scanning to a Memory Device

You can scan an original and save the scanned image to a external USB device connected to your product.

1. Insert an external USB device into the product's USB port.

2. Place your original on the product for scanning.

Note: To scan a double-sided or multi-page document, place all of the pages in the ADF.

3. Press the  home button, if necessary.
4. Select **Scan**.
5. Select **To Memory Device**.
6. Select the settings as necessary.

Note: Select  to return all save settings to their default values.

7. Select  to save your scan settings as a preset.

Note: Presets can be locked by an administrator. If you cannot access or change this setting, contact your administrator for assistance.

8. Select the **Save** icon.

Your product scans your original and saves the scanned file to the connected memory device.

Parent topic: [Starting a Scan Using the Product Control Panel](#)

Related topics

[Using External USB Devices with Your Product](#)

Scanning to the Cloud

You can use the control panel to send your scanned files to a destination that you have registered with Epson Connect.

Note: Make sure to set up your product using Epson Connect before using this feature.

1. Place your original on the product for scanning.

Note: To scan a double-sided or multi-page document, place all of the pages in the ADF.

2. Press the  home button, if necessary.
3. Select **Scan**.

4. Select **To Cloud**.
5. Select **Select Destination** and select a cloud destination.
6. Select the settings as necessary.

Note: Select  to return all save settings to their default values.

7. Select  to save your scan settings as a preset.

Note: Presets can be locked by an administrator. If you cannot access or change this setting, contact your administrator for assistance.

8. Select the **Upload** icon.

Your product scans your original and saves the scanned file to the selected destination.

Parent topic: [Starting a Scan Using the Product Control Panel](#)

Related tasks

[Setting Up Epson Connect Services](#)

[Using Epson Scan to Cloud](#)

Scanning to the Product's Hard Drive

You can use the control panel to scan files and save them to the product's hard drive.

1. Place your original on the product for scanning.

Note: To scan a double-sided or multi-page document, place all of the pages in the ADF.

2. Press the  home button, if necessary.
3. Select **Scan**.
4. Select **To Storage**.
5. Select a folder destination.
6. Select settings as necessary.

Note: Select  to return all scan settings to their default values.

7. Select  to save your scan settings.

Note: Presets can be locked by an administrator. If you cannot access or change this setting, contact your administrator for assistance.

8. Select the **Save** icon.

Your product scans your original and saves the scanned file to the selected folder.

Parent topic: [Starting a Scan Using the Product Control Panel](#)

Related topics

[Using Your Product's Internal Storage](#)

Scanning to a Connected Computer

You can scan an original and save it to a connected computer using your product's control panel. The computer must be on the same network as the product.

You can save the scanned file as a PDF file. You can also set up custom scan settings using Document Capture Pro (Windows) or Document Capture (Mac) and automatically scan using those settings on your product control panel.

Note: Be sure you have installed Epson Scan 2 and Document Capture Pro (Windows) or Document Capture (Mac) on your computer before scanning to your computer.

1. Place your original on the product for scanning.

Note: To scan a multi-page document, place all of the pages in the ADF.

2. Press the  home button, if necessary.
3. Select **Scan**.
4. Select **To Computer**.
5. Select **Select Computer** to choose a computer to scan to, and select it when it appears.

Note: The computer you want to scan to must be on the same network as the product or connected to the product with a USB cable.

6. Select one of the scan job options.
Select  to save your scan settings as a preset.

Note: The default scan job is **Scan to PDF**. Any additional scan job options must be added in Document Capture Pro (Windows) or Document Capture (Mac). If there is only one job available, you do not have to select the job.

Note: Select  to return all save settings to their default values.

7. Select the **Save** icon.

Document Capture Pro (Windows) or Document Capture (Mac) scans the original to the connected computer.

Parent topic: [Starting a Scan Using the Product Control Panel](#)

Setting Up a WSD Port (Windows 7)

You can scan to a networked Windows computer using WSD (Web Services for Devices). You must first set up a WSD port on your Windows 7 system (the port is set up automatically on Windows 11, Windows 10, and Windows 8.x).

Before you set up a WSD port, make sure you installed your product software, and connected your product and computer to the same network.

1. Turn on your product.
2. Click  and select **Computer**.
3. On the left side of the window, select **Network**.
4. Locate your product on the Network screen, right-click it, and select **Install**.
5. When you see the User Account Control screen, click **Continue**.

Note: If you see an Uninstall screen, click **Uninstall** and repeat these steps as necessary.

6. When you see the message **Your device is ready to use** in the Windows taskbar, click the message.
7. On the Driver Software Installation screen, make sure your product is listed as **Ready to use**. Then click **Close**.
8. Click  and select **Devices and Printers**.
9. Make sure that an icon appears for your product's name on the network.

When you use WSD, select your product name to scan over the network.

Parent topic: [Starting a Scan Using the Product Control Panel](#)

Control Panel Scanning Options

Select the options you want to use for scanning.

Note: Not all options or settings may be available, depending on the **Scan to** option selected.

Scan Settings	Available options	Description
Color Mode	B&W	Select to scan images in black and white
	Color	Select to scan images in color
File Format	JPEG	Select for photos. You can also select the Compression Ratio .
	PDF (Single Page)	Select for documents. You can also select the Compression Ratio and PDF Settings .
	PDF (Multi Page)	
	PDF/A (Single Page)	
	PDF/A (Multi Page)	
	TIFF (Single Page)	Select for scanned files that you can print from a device. Multi Page TIFF documents are scanned in black and white.
TIFF (Multi Page)		
Resolution	200dpi	Select for documents
	300dpi	Select for photos
	600dpi	Select for highest quality printing
2-Sided	1-Sided	Lets you scan 2-sided originals placed in the ADF. If you select 2-Sided , you can also select the Binding (Original) and Orientation (Original) setting.
	2-Sided	
Scan Area	Auto Detect	Select to automatically adjust the scan area
	Various sizes	Select the page size for documents
	User-Defined	Enter a custom scan area
	Max Area	Scan at the maximum area of the scanner glass. To specify the orientation of the original, select Orientation (Original)

Scan Settings	Available options	Description
Original Type	Text	Specify the type of original you are scanning
	Text & Image	
	Photo	
Orientation (Original)	Readable Direction	Select the orientation direction for how you placed the originals
	Left Direction	
Mixed Size Originals	Off	Select On to scan originals of varying sizes in their original sizes
	On	
Density	Varying levels	Adjust the lightness or darkness of scanned images.
Remove Background	Varying levels	Select the darkness of the background
Remove Shadow	Off	Erase the shadows that appear in the center of a document when copying a book (Center) or the shadows that appear around a document when copying thick paper (Frame)
	On	
Skip Blank Pages	—	Skip blank pages when scanning if there are any in the originals. If non-blank pages are skipped, adjust the detection level.
Remove Punch Holes	Off	Erase the binding holes on a document
	On	
ADF Continuous Scan	Off	Select On to scan a large number of originals placed in the ADF as one scanning job
	On	
Subject	—	Enter a subject for your email
Attached File Max Size	Various sizes	Select the maximum file size that can be attached to an email
File Storing	Off	Select On to save the scanned file to the printer's internal storage. Adjust the save settings, including whether to save and print or send the scanned file, or to only save the file.
	On	
File Name	—	Enter a prefix, the date, and the time to the file name for your scanned file

Scan Settings	Available options	Description
Mail Encryption	Off	Select On to encrypt emails before sending
	On	
Digital Signature	Off	Select On to attach a digital signature to emails
	On	
File Storing	—	Set the password for the file
User Name	—	Set the user name for the file
Erase Red Color	—	Remove red notes from a scanned image. This item is not available when using the To Computer , Storage to Memory Device , Storage to Email , Storage to Network Folder/FTP , or Storage to Cloud menu.

Parent topic: [Starting a Scan Using the Product Control Panel](#)

Setting Up and Scanning to a Network Folder or FTP Server

Before you can scan to a network folder on your computer or on an FTP server, you need to create a shared folder and optionally register its location to your product's Contacts list. Select the links below as necessary to create and register the folder, and to scan to it over the network.

[Creating a Shared Network Folder](#)

[Registering Contacts for Network Folder or FTP Scanning - Web Config](#)

[Registering Contacts for Email, Network, or FTP Scanning - Control Panel](#)

[Scanning to a Network Folder or FTP Server](#)

Parent topic: [Starting a Scan](#)

Creating a Shared Network Folder

You can create a shared network folder on your computer or an FTP site and register its location to your product's Contacts list.

Note: If you are creating a shared network folder on a Mac, see your Mac documentation for instructions on creating the folder. The instructions here are for Windows.

First make sure you connected your product and computer to the same network.

Note: If you are running a Home version of the Windows operating system, you cannot create a shared folder on your Windows desktop or in the Documents or Pictures folder unless you have created a Home Group Configuration for sharing. You can, however, create a shared folder in the root of the C: drive on your system.

If you want to scan to a folder on an FTP server, contact the FTP server administrator for the server address and authentication access to a shared folder on the server.

1. If you are scanning to a network folder on your computer, do one of the following to check the format of your computer name:

- **Windows 11, Windows 10, or Windows 8.x:** Hold down the Windows key on your keyboard and press the **X** key. Select **System** from the list that appears. Check the Computer Name or Device Name listed for your computer on the System window.
- **Windows 7:** Click , right-click **Computer**, and select **Properties**. Check the Computer Name listed for your computer on the System window.

Note: The settings in these steps may vary, depending on your version of Windows. See Windows Help for details on your operating system.

2. If the computer's name uses any characters that are not alphanumeric (letters or numbers), do one of the following to change the computer's name:

- **Windows 11, Windows 10, or Windows 8.x:** Select **Rename this PC** and follow the on-screen prompts.
- **Windows 7:** Select **Change Settings**, change the computer's name, and click **OK**. (See Windows Help for instructions, if necessary.)

Note: You need to be logged into Windows as an administrator to change the computer's name. After changing the name, restart your computer.

3. Start File Explorer or Windows Explorer.

4. Create a folder on the Windows desktop with a folder name of 12 characters or less; otherwise, your product may not be able to access the folder.

Note: You need to be logged into Windows as an administrator to access the desktop folder and the document folder under each User folder.

5. Right-click the folder you created and select **Properties**.

6. On the **General** tab, deselect the **Read-only** checkbox to allow users to access the folder over the network.
7. Select the **Sharing** tab and click the **Advanced Sharing** button.

Note: You need to be logged into Windows as an administrator to select the **Advanced Sharing** button.

8. On the Advanced Sharing screen, select the **Share this folder** checkbox.
9. Click the **Permissions** button and select the following on the Share Permissions tab:
 - Select **Everyone** under Group or user names.
 - Select the checkbox in the **Allow** column for the **Change** setting.
10. Click **OK** to save the settings, then click **OK** again to close the Advanced Sharing window.
11. Select the **Security** tab and check that the Group or user names list at the top includes the current computer user and the administrators who can now access the folder.
12. Select the **Sharing** tab again and write down the **Network Path** listed under Network File and Folder Sharing at the top. This is the path you will register to your product's Contacts list so you can select it for network scanning.
13. Click **OK** or **Close**.

Now you can register the folder path to your product's Contacts list.

Parent topic: [Setting Up and Scanning to a Network Folder or FTP Server](#)

Registering Contacts for Network Folder or FTP Scanning - Web Config

You can register a list of contacts for scanning to a network folder or FTP server using Web Config and your computer's internet browser.

Before you begin, print a network status sheet and locate the IP address for your product on the sheet.

Note: These instructions use Internet Explorer as an example browser.

1. Start Internet Explorer on a computer that is using the same network as your product.
2. Type your product's IP address into the address bar and press **Enter**.
3. Click **Continue to this website (not recommended)**.
4. Click the **Scan/Copy** tab.
5. Click **Contacts**.

6. Select an empty number you want to use for the contact you are adding and click **Edit**.
7. Enter the following information for the contact:
 - **Name:** The name to display in your product's contact list.
 - **Index Word:** Enter a word to identify this entry when searching for it (up to 30 characters). This field is optional.
 - **Type:** Select **Network Folder (SMB)** or **FTP**.
 - **Assign to Frequent Use:** If you want to identify the contact as a frequently used address, select **On**. This makes it quicker to select the contact when you scan.
 - **Save to:** The network path to the shared folder.
Enter the folder path name in one of the following formats depending on the **Type** setting you selected:
 - **SMB:** host_name\folder
 - **FTP:** host_name/folder_name
 - **Secure Connection:** For FTP locations, select the secure connection type.
 - **User Name** and **Password:** Enter only if you have set up a password on your computer.
 - **Connection Mode:** For FTP locations, select **Passive Mode** if there is a firewall between the product and FTP server.
 - **Port Number:** For FTP locations, enter the port number.
 - **Certificate Validation:** For FTP locations, choose to enable or disable an imported certificate.
8. Click **Apply**.
After a moment, you see a message telling you that contact registration is complete.
9. Close your web browser.

Parent topic: [Setting Up and Scanning to a Network Folder or FTP Server](#)

Registering Contacts for Email, Network, or FTP Scanning - Control Panel

You can create a list of contacts for scanning to email or to a network folder or FTP.

Note: Contacts can be locked by an administrator. If you cannot access or change contacts, contact your administrator for assistance. You can create up to 2,000 contacts and contact groups combined (including fax contacts for models with optional fax board installed).

1. Press the  home button, if necessary.

2. Select **Settings**.
3. Select **Contacts Manager**.
4. Select **Add/Edit/Delete**.
5. Select **Add New**.
6. Select **Add Contact**.
7. Do one of the following:
 - To create a contact for scanning to fax, select **Fax** (models with optional fax board installed).
 - To create a contact for scanning to email, select **Email**.
 - To create a location for scanning to a network folder or FTP, select **Network Folder/FTP**.
8. Select the number you want to use for the contact you are adding.
9. Select the **Name** field. Use the on-screen keyboard to enter the contact name (up to 30 characters) and select **OK**.
10. Select the **Index Word** field. Use the on-screen keyboard to enter a word to use when searching for an entry (up to 30 characters) and select **OK**. (This field is optional.)
11. Do one of the following:
 - For a fax contact (models with optional fax board installed), select the **Fax Number** field. Use the displayed keyboard to enter the fax number and select **OK**.
Select any other fax settings as necessary.
 - For an email contact, select the **Email Address** field. Use the on-screen keyboard to enter the address and select **OK**.
 - For a network folder or FTP location, select the **Communication Mode** field and select **Network Folder (SMB)** or **FTP**. Then select the **Location** field, use the on-screen keyboard to enter the location, and select **OK**. Enter other information if necessary.
Enter the folder path name for the **Location** setting in one of the following formats depending on the **Communication Mode** setting you selected:
 - **SMB**: \\host name\folder
 - **FTP**: ftp://host name/folder name
12. Select **OK**.

Note: If you need to edit or delete scanning contacts, the procedures are the same as for fax contacts.

Parent topic: [Setting Up and Scanning to a Network Folder or FTP Server](#)

Scanning to a Network Folder or FTP Server

You can scan an image and save it to a network folder using your product's control panel. You can either enter the folder path directly on the product's control panel or select a folder from the **Destination** tab.

Note: Make sure the date and time are set correctly before using this feature.

1. Place your original on the product for scanning.

Note: To scan a double-sided or multi-page document, place your originals in the ADF.

2. Press the  home button, if necessary.
3. Select **Scan**.
4. Select **To Network Folder/FTP**.
5. Do one of the following:
 - Choose a saved location on the **Destination** tab.
 - Select **Keyboard**, select the **Communication Mode** field, and select **Network Folder (SMB)** or **FTP**. Then select the **Location (Required)** field, enter the folder location, and select **OK**. Enter other information as necessary.

Enter the folder path name for the location setting in one of the following formats depending on the **Communication Mode** setting you selected:

- **SMB:** \\host name\folder
 - **FTP:** ftp://host name/folder name
 - **FTPS:** ftps://host name/folder name
 - **WebDAV (HTTPS):** https://host name/folder name
 - **WebDAV (HTTP):** https://host name/folder name
 - Select an email address from any displayed frequent contacts.
6. Select **Scan Settings**.
 7. Select **File Format** to choose the file format for your scan.
 8. Scroll down to select **File Name** and change it if necessary.

9. Select any additional scan settings as necessary.

Note: Select  to return all save settings to their default values.

10. Select  to save your scan settings.

Note: Presets can be locked by an administrator. If you cannot access or change this setting, contact your administrator for assistance.

11. Select the **Save** icon.



Your product scans your original and saves it in the selected location.

Parent topic: [Setting Up and Scanning to a Network Folder or FTP Server](#)

Starting a Scan Using the Epson Scan 2 Icon

You can start the Epson Scan 2 program to select scan settings, scan, and save the scanned image to a file.

Note: If you are using your Epson product with the Windows 10 S operating system, you cannot use the software described in this section. You also cannot download and install any Epson product software from the Epson website for use with Windows 10 S; you must obtain software only from the Windows Store.

- **Windows 11:** Click , then search for **Epson Scan 2** and select it.
- **Windows 10:** Click  and select **EPSON > Epson Scan 2**.
- **Windows 8.x:** Navigate to the **Apps** screen and select **Epson Scan 2**.
- **Windows (other versions):** Click  or **Start**, and select **All Programs** or **Programs**. Select **EPSON > Epson Scan 2 > Epson Scan 2**.
- **Mac:** Open the **Applications** folder, open the **Epson Software** folder, and select **Epson Scan 2**.

You see an Epson Scan 2 window like this:

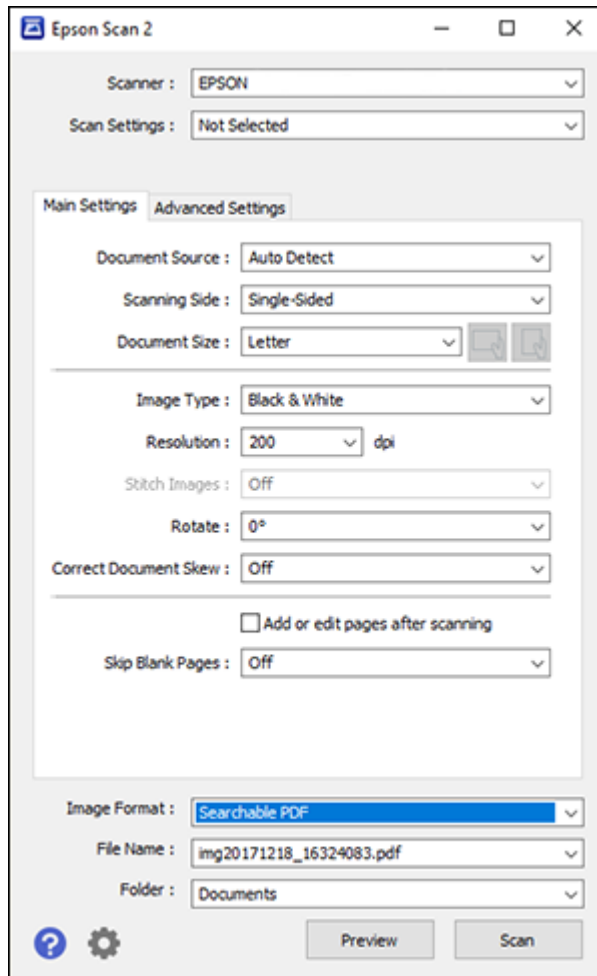

Parent topic: [Starting a Scan](#)

Starting a Scan from a Scanning Program

You can start Epson Scan 2 from a TWAIN-compliant scanning program to select scan settings, scan, and open the scanned image in the program.

Note: If you are using your Epson product with the Windows 10 S operating system, you cannot use the software described in this section. You also cannot download and install any Epson product software from the Epson website for use with Windows 10 S; you must obtain software only from the Windows Store.

1. Open your scanning program and select its scanning option. (See your scanning program help for instructions.)
2. Select your product.

Note: In certain programs, you may need to select your product as the "source" first. If you see a **Select Source** option, choose it and select your product. With Windows, do not select a **WIA** option for your product; not all scan functions will be available.

You see an Epson Scan 2 window like this:

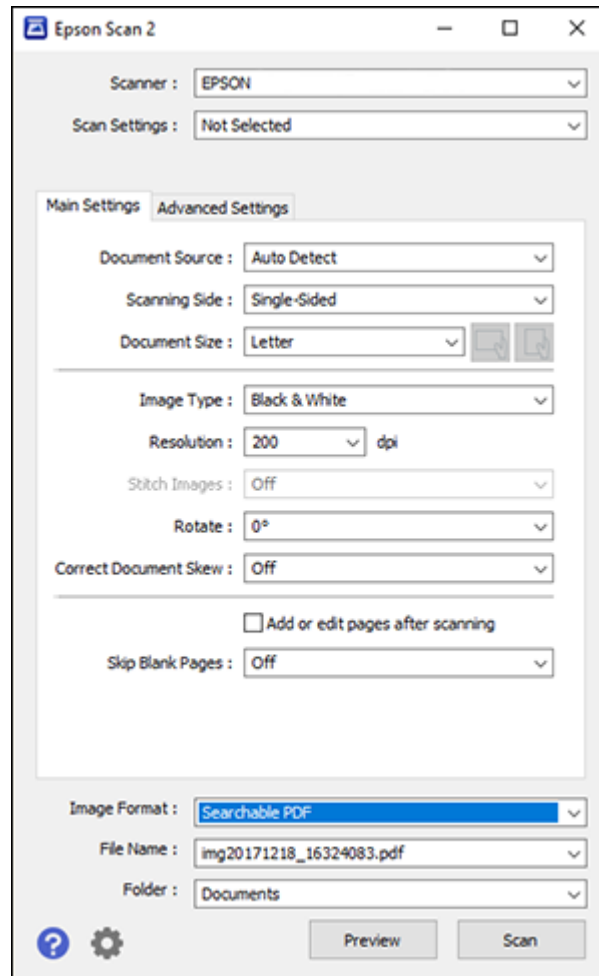

Parent topic: [Starting a Scan](#)

Starting a Scan from a Smartphone or Tablet

You can use the Epson Smart Panel app to scan from a network scanner to an iOS or Android device over a direct Wi-Fi connection.

1. Download the Epson Smart Panel app from your device's app store or from Epson's website. See the link below.
2. Place your original on the product for scanning.
3. Open the Epson Smart Panel app and select a scan menu on the home screen.
4. Follow the on-screen instructions to scan and save your original.

Parent topic: [Starting a Scan](#)

Related tasks

[Using the Epson Smart Panel Mobile App](#)

Scanning with Document Capture Pro or Document Capture

When you scan with Document Capture Pro (Windows) or Document Capture (Mac), the program automatically saves your scanned file on your computer in the folder you specify. You can preview and edit the scanned file, change the scanned file settings, and send to a destination if necessary.

[Scanning with Simple Scan in Document Capture Pro - Windows](#)

[Scanning with Job Scan in Document Capture Pro - Windows](#)



[Scanning with Document Capture - Mac](#)

Parent topic: [Scanning](#)

Scanning with Simple Scan in Document Capture Pro - Windows

You can use the Simple Scan option in Document Capture Pro to quickly scan an original.

Note: Settings may vary depending on the software version you are using. Click the **Help** icon in Document Capture Pro at any time for more information.

1. Load your original in the product.
2. Do one of the following to start Document Capture Pro:
 - **Windows 11:** Click , then search for **Document Capture Pro** and select it.
 - **Windows 10:** Click  and select **Epson Software > Document Capture Pro**.
 - **Windows 8.x:** Navigate to the **Apps** screen and select **Document Capture Pro**.
 - **Windows (other versions):** Click  or **Start**, and select **All Programs** or **Programs**. Select **Epson Software > Document Capture Pro**.

You see the Document Capture Pro window.

Note: You may need to select your scanner from the list, if necessary.

3. Select the **Simple Scan** tab.

You see a window like this:

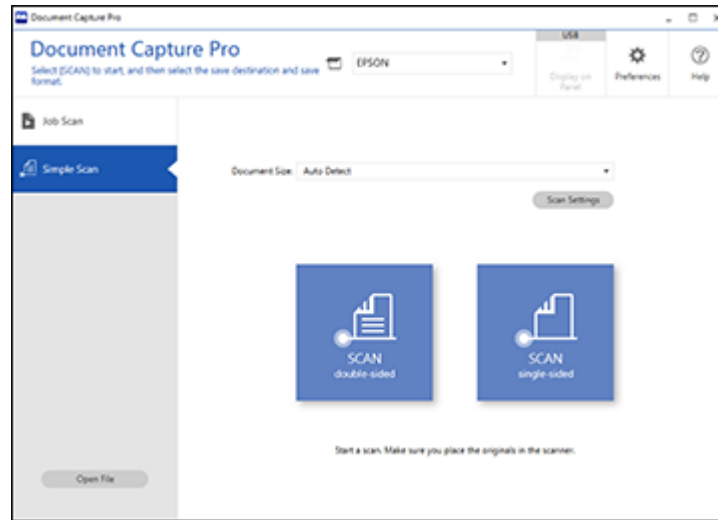

4. Select the size of your original from the **Document Size** menu.
5. If you want to change specific settings for the scan, click the **Scan Settings** button. Change any of the settings as necessary and click **OK**. For additional settings, click the **Detailed Settings** button on the Scan Settings screen.
6. Do one of the following:
 - To scan both sides of an original, select **SCAN double-sided**.
 - To scan the front side of an original, select **SCAN single-sided**.

Your product scans the original and the image appears in the Edit Scanned Results window.

7. Review and edit the scanned image as necessary and click **Next** when you are finished.

8. Select a destination for the scanned image, change any settings as necessary, and click **Complete**.



Note: If you are sending the scanned image to a server or cloud destination, you need to enter your login information.

Parent topic: [Scanning with Document Capture Pro or Document Capture](#)

Scanning with Job Scan in Document Capture Pro - Windows

You can create scan jobs in Document Capture Pro and use them to quickly scan originals and save them to various destinations.

Note: Settings may vary depending on the software version you are using. Click the **Help** icon in Document Capture Pro at any time for more information.

1. Load your original in the product.
2. Do one of the following to start Document Capture Pro:
 - **Windows 11:** Click , then search for **Document Capture Pro** and select it.
 - **Windows 10:** Click  and select **Epson Software > Document Capture Pro**.
 - **Windows 8.x:** Navigate to the **Apps** screen and select **Document Capture Pro**.
 - **Windows (other versions):** Click  or **Start**, and select **All Programs** or **Programs**. Select **Epson Software > Document Capture Pro**.

You see the Document Capture Pro window.

Note: You may need to select your scanner from the list, if necessary.

3. Select the **Job Scan** tab.

You see a window like this:

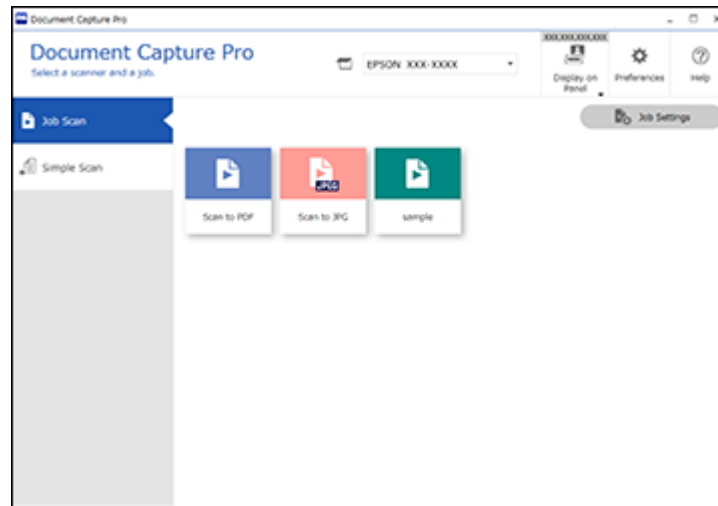

4. Select one of the scan jobs (or click **Job Settings** to create a new scan job).
The product scans the loaded original and saves it according to the job settings.
5. Depending on the settings for the scan job you selected, you may be able to view and edit the pages before saving them. If so, click **Complete** when finished.
The scanned image is saved according to the job settings.



[Adding and Assigning Scan Jobs with Document Capture Pro - Windows](#)

Parent topic: [Scanning with Document Capture Pro or Document Capture](#)

Adding and Assigning Scan Jobs with Document Capture Pro - Windows

You can add scan jobs that contain specific scan settings and use the jobs when you scan from your product control panel or the Job Scan option in Document Capture Pro. You can save up to 30 scan jobs.

Note: Settings may vary depending on the software version you are using. Click the **Help** icon in Document Capture Pro at any time for more information.

1. Do one of the following to start Document Capture Pro:
 - **Windows 11:** Click , then search for **Document Capture Pro** and select it.
 - **Windows 10:** Click  and select **Epson Software > Document Capture Pro**.
 - **Windows 8.x:** Navigate to the **Apps** screen and select **Document Capture Pro**.
 - **Windows (other versions):** Click  or **Start**, and select **All Programs** or **Programs**. Select **Epson Software > Document Capture Pro**.

You see the Document Capture Pro window.

2. Select the **Job Scan** tab.

You see a screen like this:

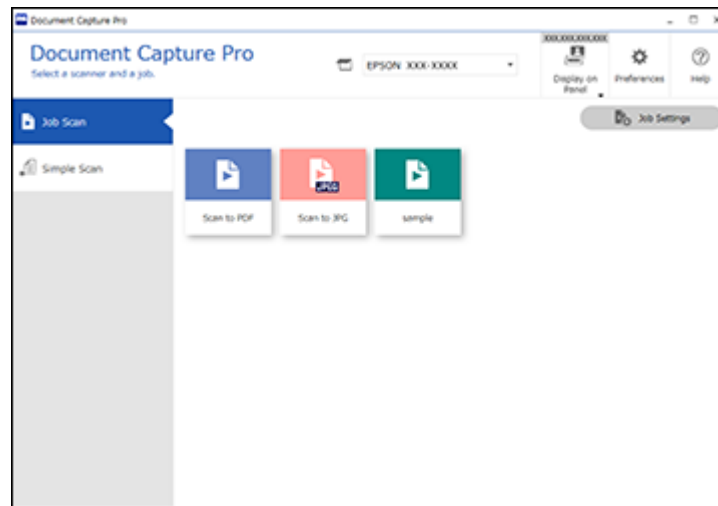

3. Click the **Job Settings** button.

You see a screen like this:

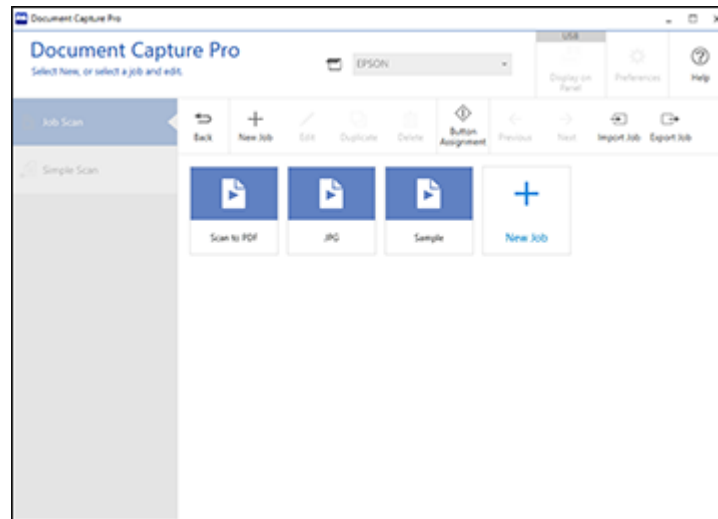

4. To add a scan job, click the **New Job** icon.
5. Enter a name for the new job, and select any settings as necessary from the following options:
 - **Scan**: select the size, color, or resolution
 - **Save**: select the file name, file type, or destination folder
 - **Index**: enable the index setting and choose output options for an index file
 - **Send**: select the destination for the scanned file, or choose to email or print the file
 - **Confirm/Test**: select the job button icon and color, choose display settings, and run a test scan if necessary
6. Click **Save** when you are finished.
The new job appears in the Job Scan window.
7. To assign a scan job to the product control panel, click the **Button Assignment** icon.

You see a screen like this:

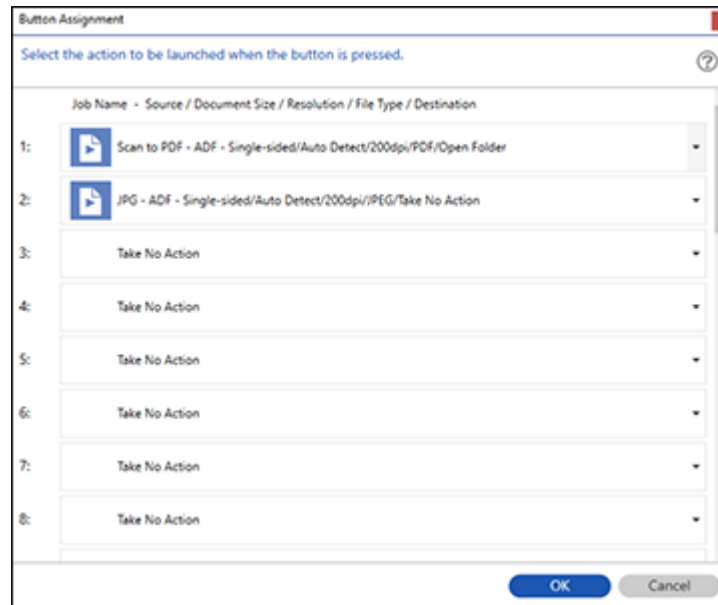

8. Select the jobs that you want to assign to the product control panel using any of the pull-down menus.

Note: The number of pull-down menus available may vary, depending on your product and any connected options.

9. Click **OK**, then click **Back**.

You can now use the added scan jobs when you scan from the product control panel.

Parent topic: [Scanning with Job Scan in Document Capture Pro - Windows](#)

Scanning with Document Capture - Mac

When you scan with Document Capture, the program automatically saves your scanned file on your computer in the folder you specify. You can select settings, preview, and change the scanned file settings as necessary. Document Capture also allows you to send the scanned file directly to an email address or printer, or upload it to a server or cloud destination.

Note: Settings may vary depending on the software version you are using. See the **Help** menu in Document Capture at any time for more information.

1. Load your original in the product.
2. Open the **Applications** folder, open the **Epson Software** folder, and select **Document Capture**.

You see a window like this:

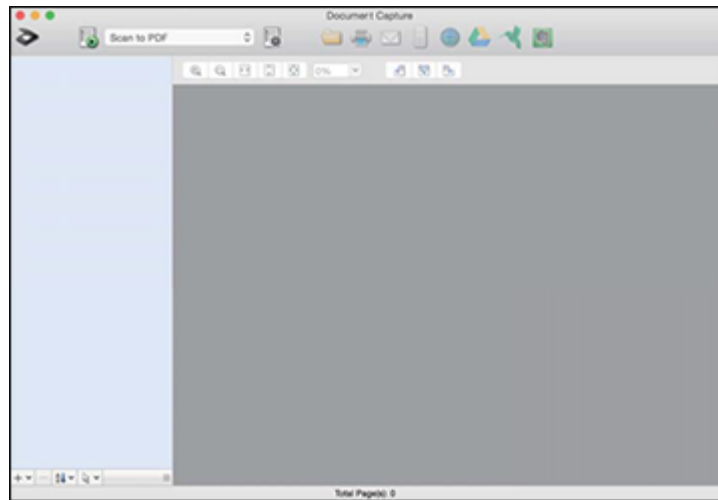

Note: You may need to select your product from the drop-down list.

3. Click the  scan icon.

You see a window like this:

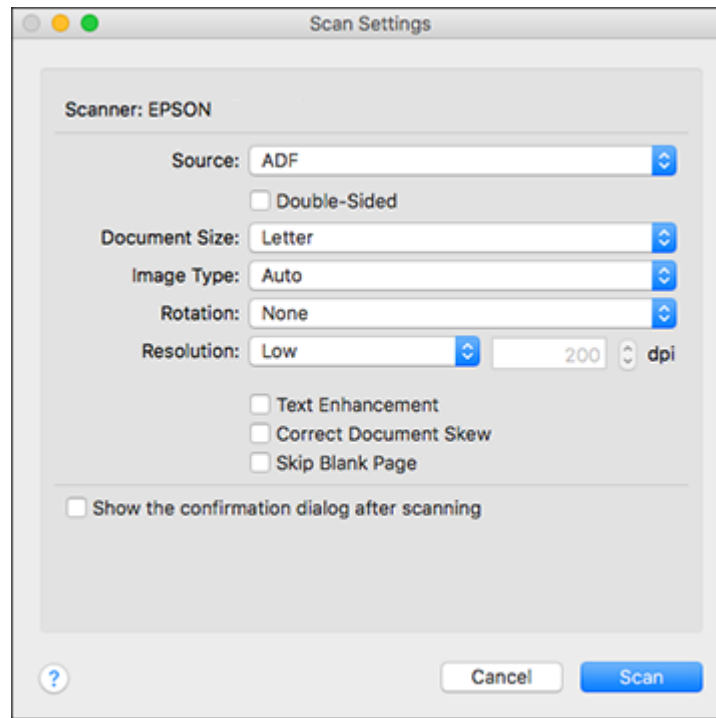

Note: If you want to use a scan job that you created instead, select it from the Job list in the Document Capture window, click the  Start Job button, and skip the rest of these steps.

4. Select any displayed scan settings you want to use.

Note: See the Help information in Document Capture for details.

5. If you want to select detailed scan settings, close the Scan Settings window, open the **Scan** menu at the top of the Mac desktop, and select **Displays the EPSON Scan Setup Screen**.
6. Click the  Scan icon and select any detailed scan settings you want to use from the Epson Scan 2 window.
7. Click **Scan**.

You see a preview of your scan in the Document Capture window.

Note: You may have to close the Epson Scan 2 window to view your scan in the Document Capture window.

8. If you would like to scan additional originals and add them to the current captured images, click the + icon, select **Acquire from Scanner**, and repeat the previous steps.
9. Check the scanned images and edit them as necessary.
10. Click one of the destination icons to choose where to send your scanned files. (If you cannot see all of the icons, click the arrow next to the icons.) Change any settings as necessary.



Note: If you are sending the scanned image to a server or cloud destination, you need to enter your login information. If you want to use Evernote as the destination, download the Evernote application from the Evernote Corporation website and install it before scanning.

11. Depending on the destination you chose, click **OK** or **Send** to complete the operation.

Parent topic: [Scanning with Document Capture Pro or Document Capture](#)

Scanning in Epson Scan 2

Epson Scan 2 gives you access to basic and advanced scanning features. You can scan your document and save the scanned image in various file formats in your operating system's Documents or My Documents folder, or open it in your scanning program. You can preview the scanned image and select or change settings as necessary.

Note: If you are using your Epson product with the Windows 10 S operating system, you cannot use the software described in this section. You also cannot download and install any Epson product software from the Epson website for use with Windows 10 S; you must obtain software only from the Windows Store.

1. Start Epson Scan 2.

You see this window:

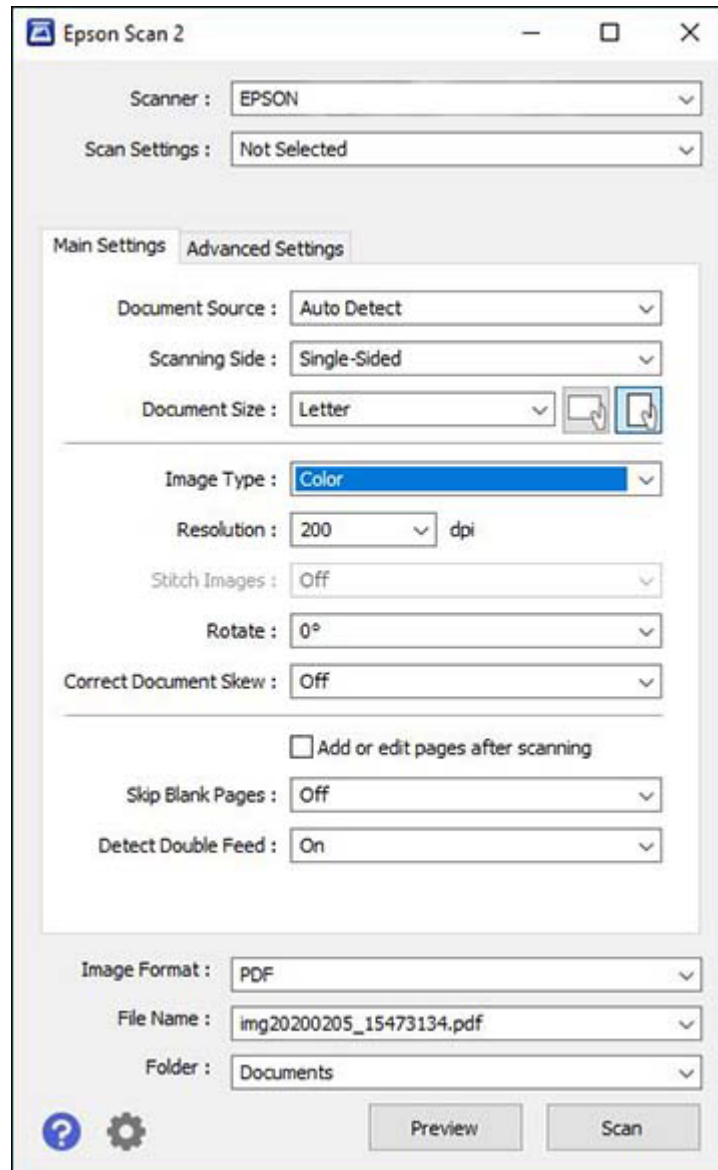

2. Select the **Document Source** setting that matches where you placed your original.
3. Select the **Document Size** setting that matches the size of your original. You can select **Customize** to enter a custom size, if necessary.
4. Select the image type of your original and how you want it scanned as the **Image Type** setting.
5. Select the **Resolution** setting you want to use for your scan.
6. Click the **Preview** button.
Epson Scan 2 previews your original and displays the results in the Epson Scan 2 window.
7. Click the **Advanced Settings** tab and select any settings that you want to use.
8. Select the format in which you want to save your scanned file as the **Image Format** setting. If necessary, select **Options** and select any desired format options.
9. Enter the file name for your scanned file in the **File Name** field. If necessary, select **Settings** to modify the file name settings.
10. Select the location in which you want to save your scanned file as the **Folder** setting. If necessary, select **Select** to create a new folder.
11. Click **Scan**.

The product scans your original and saves the scanned file in the location you specified.

[Additional Scanning Settings - Main Settings Tab](#)

[Additional Scanning Settings - Advanced Settings Tab](#)

[Saving Scanned Documents as a Searchable PDF Using Epson Scan 2](#)

[Image Format Options](#)

[Scan Resolution Guidelines](#)

Parent topic: [Scanning](#)

Additional Scanning Settings - Main Settings Tab

You can select these additional scanning settings on the Epson Scan 2 Main Settings tab. Not all adjustment settings may be available, depending on other settings you have chosen.

Stitch Images

When scanning double-sided originals, lets you lay out images from both sides of the original onto one scanned page.

Rotate

Rotates the original image clockwise to the desired angle before scanning it. Select **Auto** to allow your product to automatically rotate the image based on the orientation of the text (may take longer to scan).

Correct Document Skew

Corrects skewed originals, image contents, or both.

Add or edit pages after scanning

Lets you add, remove, or edit the pages in a scan, including rotating pages and changing the page order.

Note: To save multiple pages in a single file, you must select a file format that supports multiple pages such as **PDF** or **Multi-TIFF**. If you select another file format, each scanned image or page is saved as a separate file.

Skip Blank Pages

If the scanner detects marks from the other side of a blank page and adds the marks to the scanned image, adjust this setting to prevent this.

Parent topic: [Scanning in Epson Scan 2](#)

Additional Scanning Settings - Advanced Settings Tab

You can select these additional scanning settings on the Epson Scan 2 Advanced Settings tab. Not all adjustment settings may be available, depending on other settings you have chosen.

Text Enhancement

Sharpens the appearance of letters in text documents.

Auto Area Segmentation

Makes black and white images clearer and text recognition more accurate by separating the text from the graphics.

Threshold

Adjusts the level at which black areas in text and line art are delineated, improving text recognition in OCR (Optical Character Recognition) programs.

Color Enhance

Enhances the shades of the color you select in the scanned image. This setting is available only if you select **Grayscale** or **Black & White** as the Image Type setting.

Brightness

Adjusts the overall lightness and darkness of the scanned image.

Contrast

Adjusts the difference between the light and dark areas of the overall scanned image.

Gamma

Adjusts the midtone density of the scanned image.

Sharpness

Makes the edges of certain image areas clearer. Turn off this option to leave softer edges.

Descreening

Removes the ripple pattern that might appear in subtly shaded image areas, such as skin tones. This option improves results when scanning magazines or newspapers. (The results of descreening do not appear in the preview image, only in your scanned image.)

Edge Fill

Corrects shadowing around the edges of the image by filling the shadows with black or white.

Dual Image Output

Scans the original image twice using different output settings (Windows only).

Watermark

Adds a watermark to a scanned image.

Parent topic: [Scanning in Epson Scan 2](#)

Saving Scanned Documents as a Searchable PDF Using Epson Scan 2

You can scan a document and save the text in a searchable PDF. In a searchable PDF, text is recognized using Optical Character Recognition (OCR) and then embedded in the scanned original.

Note: The required Epson Scan 2 OCR Component is installed automatically when you install your product software. If you install your product software programs individually, be sure to also install this component if you want to perform OCR.

1. Load your original in the product for scanning.
2. Start Epson Scan 2.
3. Select your scan settings.
4. Click **Preview** and adjust the area you want to scan, if necessary.
5. If you are using the ADF, reload the ejected original.
6. Select **Searchable PDF** as the Image Format setting.
7. Select **Options** from the Image Format list.

You see this window:

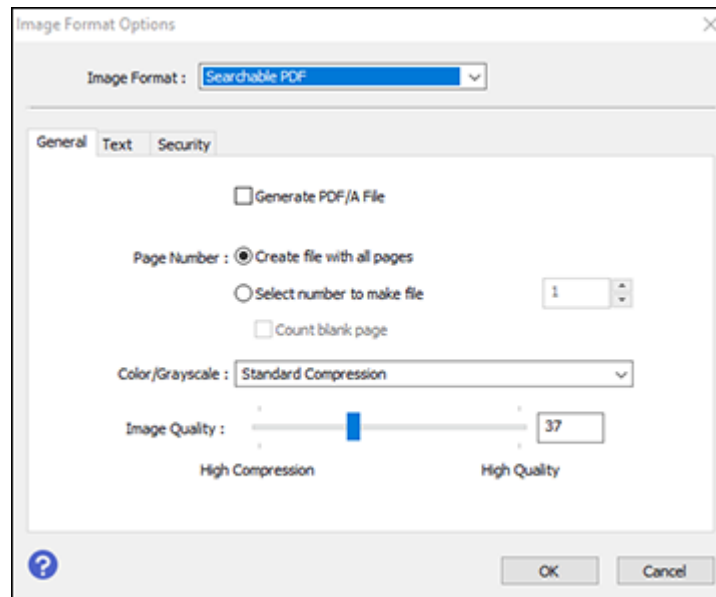

8. Select any of the options on the General tab.
9. Select the **Text** tab.
10. Make sure the language used in the document text is selected as the **Text Language** setting.
11. Select the **Security** tab if you want to add a password to the PDF or protect printing or editing properties.
12. Click **OK**.
13. Confirm the **File Name** setting and select a **Folder** setting for your document.
14. Click **Scan**.

The scanned image is saved as a searchable PDF.

Parent topic: [Scanning in Epson Scan 2](#)

Image Format Options

You can select different image formats and related options. For details on available options, click the ? icon on the Epson Scan 2 Image Format Options window. Not all image formats have options.

BITMAP (*.bmp)

A standard image file format for most Windows programs.

JPEG (*.jpg)

An image format that lets you highly compress image data. However, the higher the compression, the lower the image quality. (The TIFF format is recommended when you need to modify or retouch your scanned image.)

PNG (*.png)

An image format that does not lose quality during editing.

TIFF (*.tif)

A file format created for exchanging data between many programs, such as graphic and DTP software.

Multi-TIFF (*.tif)

A TIFF file format when multiple pages are saved to the same file, allowing you to edit the images using a compatible program.

PDF (*.pdf)

A document format that is readable by Windows and Mac systems using Adobe Reader, Acrobat, or other programs. You can save multi-page documents in one PDF file.

Searchable PDF (*.pdf)

A document format that is readable by Windows and Mac systems using Adobe Reader, Acrobat, or other programs. You can save multi-page documents in one PDF file. Recognized text in the scanned document can be searched.

In order to use the OCR option to create searchable PDFs, you must install the OCR license key.

Parent topic: [Scanning in Epson Scan 2](#)

Scan Resolution Guidelines

The **Resolution** setting, measured in dpi (dots per inch), controls the amount of detail captured in your scans. Increasing the resolution raises the amount of detail captured but comes with the following disadvantages:

- Larger file sizes
- It takes longer to scan your originals, send/receive your scans by email or fax, and to print your scans
- The image may become too large to fit on your display or print on paper

If you plan to enlarge a scanned image so you can print it at a larger size, you may need to increase the resolution from the default resolution set by Epson Scan 2. Follow these guidelines to determine the resolution setting you need:

- You will scan the image at its original size but enlarge it later in an image-editing program.
Increase the Epson Scan 2 Resolution setting in your scan. Increase the resolution by the same amount you will increase the image size to retain a high image quality. For example, if the resolution is 300 dpi (dots per inch) and you will double the image size later, change the Resolution setting to 600 dpi.
- You will scan the image at 100% or a smaller size.
Select the Epson Scan 2 Resolution setting based on how you will use the scanned image:
 - Email/view on a computer screen/post on the web: 96 to 200 dpi
 - Print/fax/convert to editable text (OCR)/create searchable PDF: 200 to 300 dpi

Parent topic: [Scanning in Epson Scan 2](#)

Scanning Special Projects

Your product's scanning software offers various options to help you quickly complete special scan projects.

[Scanning to a SharePoint Server or Cloud Service - Windows](#)



[Scanning Multi-Page Originals as Separate Files - Windows](#)

Parent topic: [Scanning](#)

Scanning to a SharePoint Server or Cloud Service - Windows

You can use Document Capture Pro (Windows) to upload scanned images to a SharePoint server or a cloud service.

Note: The settings may vary, depending on the software version you are using. See the help information in Document Capture Pro for details.

1. Load your original in the product.
2. Do one of the following to start Document Capture Pro:
 - **Windows 11:** Click , then search for **Document Capture Pro** and select it.
 - **Windows 10:** Click  and select **Epson Software > Document Capture Pro**.

- **Windows 8.x:** Navigate to the **Apps** screen and select **Document Capture Pro**.
 - **Windows (other versions):** Click  or **Start**, and select **All Programs** or **Programs**. Select **Epson Software > Document Capture Pro**.
3. Select the **Simple Scan** tab.
You see a window like this:

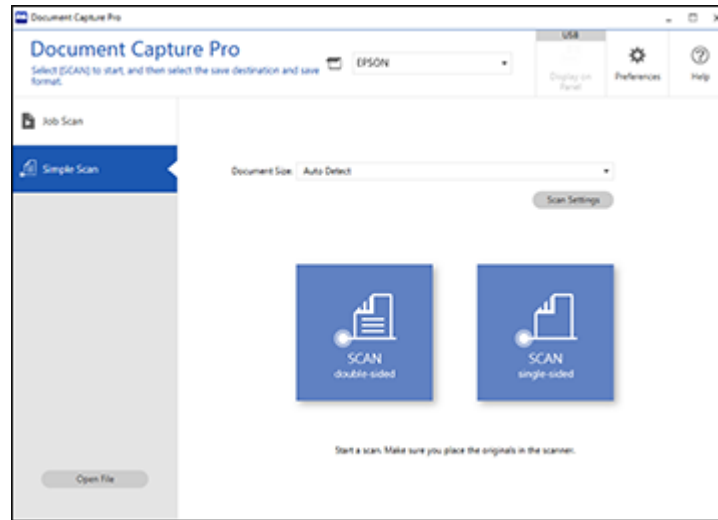

4. If you want to select specific scan settings for the scan, click the **Scan Settings** button, select any displayed settings you want to use, and click **OK**.

Note: See the help information in Document Capture Pro for details.

5. Do one of the following:
- To scan both sides of an original, select **SCAN double-sided**.
 - To scan the front side of an original, select **SCAN single-sided**.

Your product starts scanning and you see the Edit Scanned Results window.

6. View and edit the scanned pages as necessary and click **Complete** when you are finished.

Note: See the help information in Document Capture Pro for details.

7. Click one of the cloud server or service destination icons. You see the settings window.
8. Enter any required information to set up the destination. You may need to log in to your cloud service to authenticate the connection and allow Document Capture Pro to access the cloud service.
9. Adjust any settings and click **Complete**.

Note: See the help information in Document Capture Pro for details.



Your originals are uploaded to the indicated server or cloud service.

Parent topic: [Scanning Special Projects](#)

Scanning Multi-Page Originals as Separate Files - Windows

You can use Document Capture Pro to scan multi-page originals as separate scanned files. You can indicate how the separate files are created by defining a maximum page count per file or by inserting blank pages, barcodes, or characters that can be detected by the software as separation markers.

Note: Settings may vary depending on the software version you are using. Click the **Help** icon in Document Capture Pro at any time for more information.

1. Load your multi-page original in the product.
2. Do one of the following to start Document Capture Pro:
 - **Windows 11:** Click , then search for **Document Capture Pro** and select it.
 - **Windows 10:** Click  and select **Epson Software > Document Capture Pro**.
 - **Windows 8.x:** Navigate to the **Apps** screen and select **Document Capture Pro**.
 - **Windows (other versions):** Click  or **Start**, and select **All Programs** or **Programs**. Select **Epson Software > Document Capture Pro**.

You see the Document Capture Pro window.

3. Select the **Job Scan** tab.

You see a window like this:

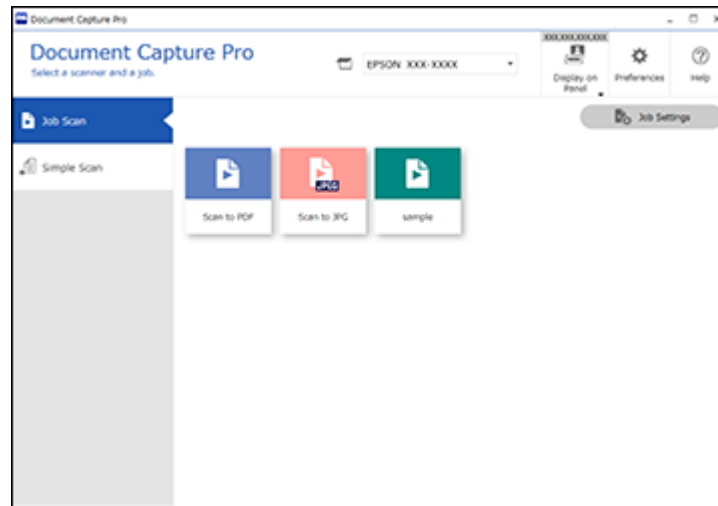

4. Click the **Job Settings** button.

You see a window like this:

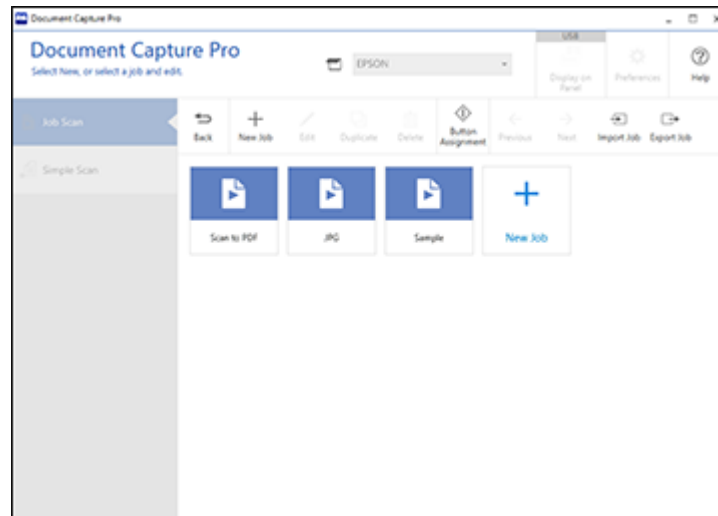

5. Select **New Job** and select the scan settings. Click **Next** when finished.

You see a window like this:

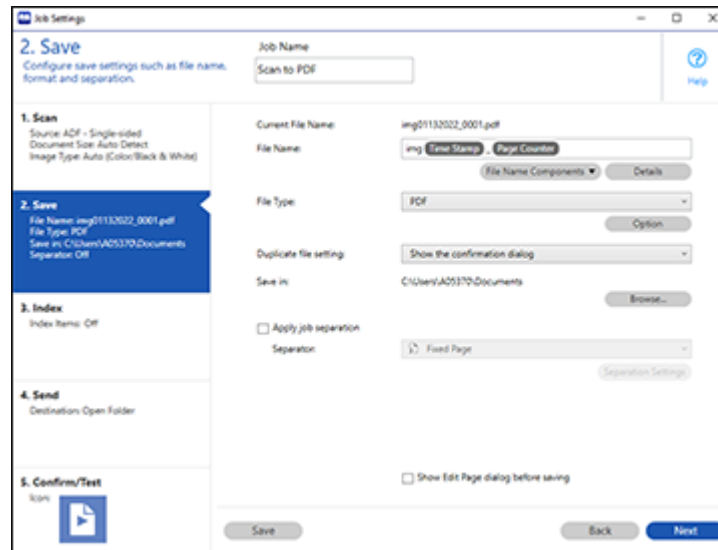

6. Select the **Apply job separation** checkbox.
7. Select the method you want to use to separate the originals as the **Separator** setting. Click **Separation Settings** to specify the settings for the selected option.
8. Finish creating the new scan job and click **Save**.
9. Click **Back** on the Job Settings screen.

Your originals are saved into separate files and folders as specified when the job is run.

Parent topic: [Scanning Special Projects](#)

Entering a User ID and Password for Scanning

If you enabled Access Control on your product, a user ID and password may be required to scan. You can enter the user ID and password in Epson Scan 2.

Note: If you do not know the user ID or password, contact your administrator for assistance.

1. Start Epson Scan 2.

2. Select **Settings** from the **Scanner** drop-down list.

You see this window:

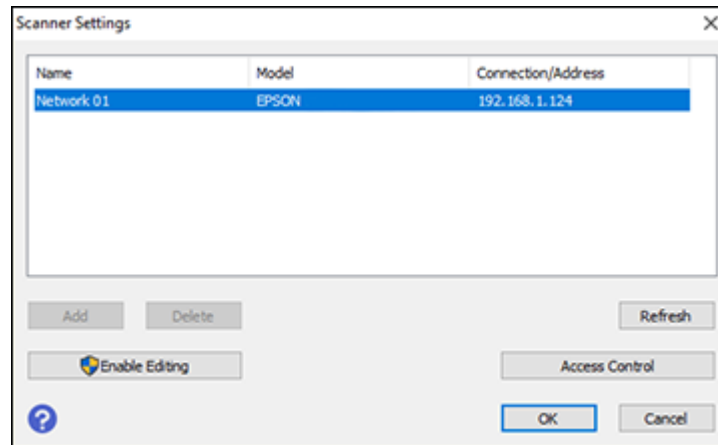

3. Select **Access Control**.
4. Enter your user name and password.
5. Click **OK**.

Parent topic: [Scanning](#)

Related topics

[Restricting Features Available for Users](#)

Faxing

See these sections to fax using your product.

Note: An optional fax board must be installed on your product before you can fax. Once the optional fax board is installed, download and install the Epson Fax Utility software. Visit epson.com/support (U.S.), epson.ca/support (Canada), or latin.epson.com/support (Latin America) and select your product.

Note: This product allows you to store names, telephone numbers, and fax data in its memory even when the power is turned off. Make sure you restore all of the default settings if you give away or dispose of the product. This will erase all of your network settings and fax data.

Note: When using the Epson Universal Print Driver or PostScript (PS3) printer software with the product, you can fax using the printer buttons or the utilities included with the standard Epson printer software. To download the standard Epson printer software, visit epson.com/support (U.S.), epson.ca/support (Canada), or latin.epson.com/support (Latin America) and select your product.

[Connecting a Telephone or Answering Machine](#)

[Setting Up Fax Features](#)

[Setting Up Contacts and Contact Groups](#)

[Sending Faxes](#)

[Receiving Faxes](#)

[Checking Fax Status](#)

[Printing Fax Reports](#)

Connecting a Telephone or Answering Machine

You must connect your product to a telephone wall jack to send or receive faxes. If you want to use the same telephone line to receive calls, you can connect a telephone or answering machine to your product using an additional phone cable.

Note: If you do not connect a telephone to your product, make sure **Receive Mode** is set to **Auto**. Otherwise, you cannot receive faxes.

1. Connect a phone cable to your telephone wall jack and to the **LINE** port on your product.

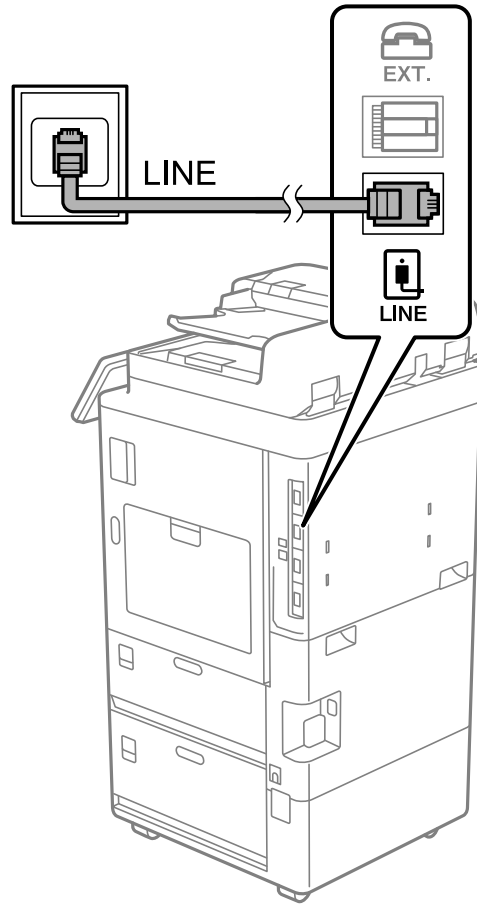

Note: If more than one optional fax board is installed on your product, you can connect more than one phone cable.

Note: If you have a DSL or ISDN connection, you must connect the appropriate DSL filter, or ISDN terminal adapter or router to the wall jack to be able to use the line for faxing or voice calls using your product. Contact your DSL or ISDN provider for the necessary equipment.

DSL connection

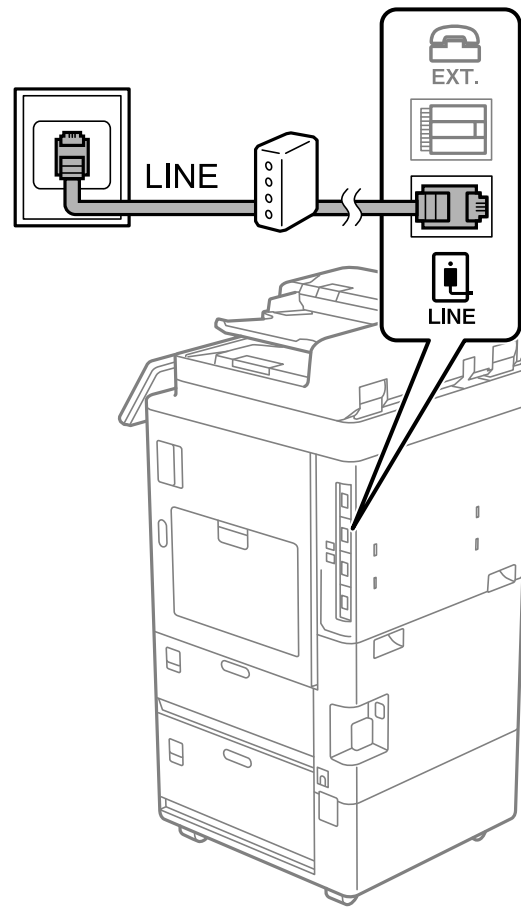

ISDN connection

2. If you are connecting a telephone or answering machine to your product using a second phone cable, remove the cap from the **EXT.** port on your product.

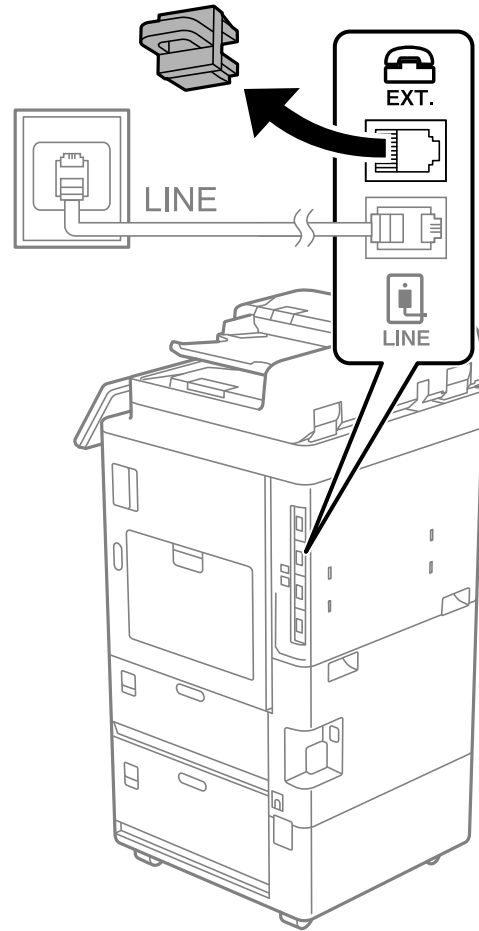

3. Connect a second phone cable to your telephone or answering machine and to the **EXT** port on your product.

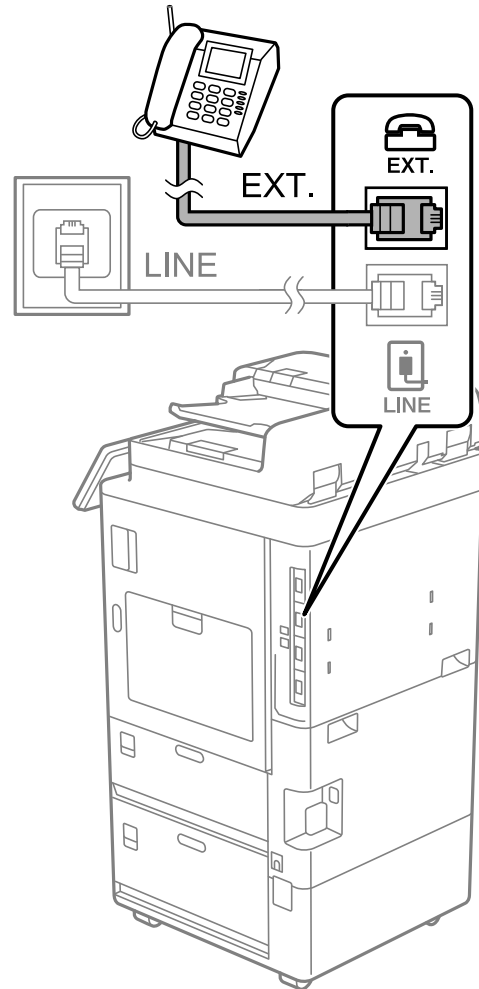

Note: If you connect an answering machine and **Receive Mode** is set to **Auto**, set the number of rings before your product answers a call to a number that is higher than your answering machine's setting for the number of rings.

Any phone or answering machine must be connected to the **EXT** port for your product to detect an incoming fax call when the phone is picked up. Epson cannot guarantee compatibility with VoIP, cable phone systems, or fiberoptic digital services such as FIOS.

Parent topic: [Faxing](#)

Setting Up Fax Features

Before faxing with your product, set up your fax header and select the fax features you want to use.

Note: If you leave your product unplugged for a long period of time, you may need to reset the date and time settings for faxes.

[Setting Up Basic Fax Features](#)

[Selecting Advanced Fax Settings](#)

[Setting Up the Fax Utility - Windows](#)

Parent topic: [Faxing](#)

Setting Up Basic Fax Features

See these sections to select the basic settings you need to use the product's fax features.

[Using the Fax Setup Wizard](#)

[Selecting the Line Type](#)

[Setting the Number of Rings to Answer](#)

Parent topic: [Setting Up Fax Features](#)

Using the Fax Setup Wizard

You can setup the product's basic fax settings using the Fax Setting Wizard. This wizard is automatically displayed when the product is turned on for the first time. You can also change these settings individually from the Fax Settings menu.

Note: These settings can be locked by an administrator. If you cannot access or change these setting, contact your administrator for assistance.

1. Press the  home button, if necessary.
2. Select **Settings** > **General Settings** > **Fax Settings** > **Fax Setting Wizard**.
3. Select **Proceed**.

4. On the fax header screen, use the displayed keypad to enter the sender name for your fax source, such as your name or a business name. You can enter up to 40 characters. Select **OK** when you are done.
5. On the phone number screen, use the displayed keypad to enter your fax number, up to 20 characters. Select **OK** when you are done.

Note: The name and phone number in the fax header identifies the source of the faxes you send.

6. On the Distinctive Ring Setting screen, do one of the following:
 - If you have subscribed to a distinctive ring service from your telephone company, select **Proceed**. Select the ring pattern to be used for incoming faxes and skip to step 9. If you select **All**, go to the next step.
 - If you do not have a distinctive ring service, select **Skip** and go step 9.

Note: Distinctive ring services allows you to have several phone numbers on one phone line. Each number is assigned a different ring pattern. You can use one number for voice calls and another for fax calls. Select the ring pattern assigned to fax calls in the DRD Setting. If you select a ring pattern other than **All**, Receive Mode is automatically set to **Auto**.

7. On the Receive Mode Setting screen, do one of the following:
 - If you have connected an external telephone or answering machine to the product, select **Yes** and go to the next step.
 - If you did not connect an external telephone or answering machine, select **No** and go to step 9. (Receive Mode is automatically set to **Auto**; otherwise you cannot receive faxes.)
8. On the next Receive Mode Setting screen, select **Yes** to receive faxes automatically or select **No** to receive faxes manually.

Note: If you connect an external answering machine and select to receive faxes automatically, make sure the **Rings to Answer** setting is correct. If you select to receive faxes manually, you need to answer every call and operate the product's control panel or your phone to receive faxes.

9. On the Proceed screen, confirm the displayed settings and select **Proceed**, or press the back arrow to change the settings.
10. On the Run Check Fax Connection screen, select **Start Checking** and follow the on-screen instructions to check the fax connection and print a report of the check result. If there are any errors reported, try the solutions on the report and run the check again.

11. If the Select Line Type screen appears, select the correct line type.
 - If you are connecting the printer to a PBX phone system or terminal adapter, select **PBX**.
 - If you are connecting the printer to a standard phone line, select **PSTN**, and then select **Do Not Detect** on the **Confirmation** screen displayed. However, setting this to **Do Not Detect** may cause the printer to skip the first digit of a fax number when dialing and send the fax to the wrong number.

Parent topic: [Setting Up Basic Fax Features](#)

Selecting the Line Type

If you connect the product to a PBX phone system or terminal adapter, you must change the product's line type. PBX (Private Branch Exchange) is used in office environments where an external access code such as "9" must be dialed to call an outside line. The default Line Type setting is PSTN (Public Switched Telephone Network), which is a standard home phone line.

Note: This setting can be locked by an administrator. If you can't access or change this setting, contact your administrator for assistance.

1. Press the  home button, if necessary.
2. Select **Settings > General Settings > Fax Settings > Basic Settings > Line Type > PBX**.
3. Select **Access Code**.
4. Select **Use**.
5. Select the Access Code field.
6. Use the displayed keypad to enter the access code, such as 9, and select **OK**.

Parent topic: [Setting Up Basic Fax Features](#)

Setting the Number of Rings to Answer

If you connect an external answering machine and select to receive faxes automatically, make sure the Rings to Answer setting is correct. The number of rings should be higher than the number of rings your answering machine is set to for answering a call.

Note: This setting can be locked by an administrator. If you cannot access or change this setting, contact your administrator for assistance.

1. Press the  home button, if necessary.
2. Select **Settings > General Settings > Fax Settings > Basic Settings > Rings to Answer**.

3. Select the number of rings and select **OK**. Make sure to select a number higher than the number of rings your answering machine is set to for answering a call.

Note: An answering machine picks up every call faster than the product, but the product can detect fax tones and start receiving faxes. If you answer the phone and hear a fax tone, check that the product has started receiving the fax, then hang up the phone.

Parent topic: [Setting Up Basic Fax Features](#)

Selecting Advanced Fax Settings

You can select a variety of advanced fax settings.

Note: These settings can be locked by an administrator. If you cannot access or change these setting, contact your administrator for assistance.

1. Press the  home button, if necessary.
2. Select **Settings > General Settings > Fax Settings**.
3. Select the group of settings you want to change.

[Basic Settings - Fax](#)

[Send Settings - Fax](#)

[Receive Settings - Fax](#)

[Report Settings - Fax](#)

[Security Settings - Fax](#)

Parent topic: [Setting Up Fax Features](#)

Basic Settings - Fax

Set the basic options you want to use for incoming and outgoing faxes.

Note: If more than one optional fax board is installed on your product, the **Expansion Line Settings** menu appears. You can select certain settings below for each added line.

Setting	Options	Description
Fax Speed	Fast(33,600bps)	Sets the speed at which you send and receive faxes.
	Medium(14,400bps)	
	Slow(9,600bps)	
ECM	On	Turns on Error Correction Mode (ECM) to automatically correct errors in sent or received fax data.
	Off	Turns off Error Correction Mode (ECM); color faxes cannot be sent or received.
Dial Tone Detection	On	Automatically dials the number you enter for faxing when the product detects a dial tone.
	Off	Turns off automatic dial tone detection, which may be necessary if the product is connected to a PBX (Private Branch Exchange) or a TA (Terminal Adapter). However, turning this setting off may cause the product to drop the first digit of a fax number.
Line Type	PSTN	Selects a standard phone line (Public Switched Telephone Network).
	PBX	Selects Private Branch Exchange, the type of phone line used in office environments where an access code such as 9 must be used to call an outside line.
Header	Your Phone Number	Select to enter the header information and your phone number for inclusion on outgoing faxes.
	Fax Header	
Receive Mode	Manual	Lets you confirm whether an incoming fax should be printed; a telephone must be connected to the product
	Auto	Automatically receives and prints faxes.

Setting	Options	Description
Distinctive Ring	All	If you are using a Distinctive Ring Service on your phone line, your telephone company can assign two or more phone numbers to the same line and assign different ring patterns to each. If you use this service, select the number of rings for your fax number so your product can receive faxes on the correct number of rings. Select All for phones lines that do not use this service.
	Single	
	Double	
	Triple	
	Double&Triple	
Rings to Answer	1 to 9	Sets the number of rings before your product receives a fax. If Receive Mode is set to Auto and an answering machine is connected to the product, make sure this setting is set higher than the number of rings your answering machine is set to answer a call.
Remote Receive	Off	Lets you start receiving faxes using your phone instead of operating the product (if the Receive Mode is set to Auto). When you select On , you must also set a Start Code . If you are using a cordless handset with its base connected to the product, you can start receiving the fax by entering the code using the handset.
	On	
	Start Code	
Rejection Fax	Various	Lets you automatically reject faxes from blocked numbers, with blank headers, or from unrecognized contacts.
Receiving Paper Size	Various	Selects the paper size for incoming faxes.
Save/Forward File Format	PDF	Saves or forwards a fax as a PDF file. You can also set a password for opening the PDF or allowing printing and editing permissions.
	TIFF	Saves or forwards a fax as a TIFF file.

Setting	Options	Description
Cloud Destination List	Various	When using Epson Connect, you can register up to five addresses to the cloud service that is being administered by Epson Connect. You can upload document data as a file when forwarding faxes by specifying the registered address as a destination. Depending on the country and region, you may not be able to use online services.

Parent topic: [Selecting Advanced Fax Settings](#)

Send Settings - Fax

Set the send options you want to use for outgoing faxes.

Setting	Options	Description
Auto Rotation	Off	Sends an A4 or letter-size document that is placed long edge first into the ADF as an A3-size fax. When you place A4 size originals with their long edge facing to the left and A3 size originals in the ADF, you can rotate the scanned A4 size originals to send them at A4 size by selecting Off as the Direct Send setting.
	On	
Quick memory send	Off	Sends the first page of a multi-page document as soon as it finishes scanning. Select this option to decrease the amount of time it takes to fax a document.
	On	
Batch Send	Off	Sorts outgoing faxes by recipient in the product's memory, and then sends them as a batch. Up to five documents (200 pages total) can be sent at one time.
	On	
Save Failure Data	Off	Saves faxes that failed to be sent in the product's memory. You can resend the faxes from the product's Job/Status screen. When you select On , you can select a time period to store the saved faxes.
	On	

Setting	Options	Description
Wait Time for Next Original	Off	Sets a time in between sending the next fax.
	On	
Fax Preview Display Time	Off	Sets a time for previewing the scanned document on the LCD screen before it is sent.
	On	
Allow Backup	Allowed	Allows you to back up sent faxes. Select Fax > Fax Settings > Backup to view backed up faxes.
	Not Allowed	

Parent topic: [Selecting Advanced Fax Settings](#)

Receive Settings - Fax

Set the save/forward or print options you want to use for incoming faxes.

Save/Forward Settings

Setting	Options	Description
Unconditional Save/Forward	Save to Inbox	Saves received faxes in printer's inbox
	Save to Computer	Converts received faxes to PDFs and saves them on a computer connected to the printer
	Save to Memory Device	Converts received faxes to PDFs and saves them on an external memory device connected to the printer
	Forward	Forwards received faxes to another fax machine, or converts them to PDFs or TIFFs and forwards them to a shared folder on a network, or an email address. You can also forward them to a cloud destination in either PDF or JPEG format. Forwarded faxes are deleted from the printer.
	Email Notifications	Sends an email notification after a fax is received, printed, saved, or forwarded
Conditional Save/Forward	—	Sets up conditions to save, forward, or print received faxes. Select Unregistered to enter conditions and other settings.

Setting	Options	Description
Common Settings	Inbox Settings	Sets up what happens when the fax memory is full, or sets up a password for the inbox.
	Email Subject to Forward	Specifies a subject when forwarding a fax to an email address.
	Box Document Delete Settings	Select On to automatically delete received faxes after a set period of time.

Print Settings

Setting	Options	Description
Auto Reduction	On	Select to reduce the size of large received faxes to fit on the paper size in the selected paper source.
	Off	Select to print large incoming faxes at their original size on multiple sheets, if necessary.
Split Page Settings	Delete Print Data After Split	Select how to split large incoming faxes across multiple sheets when using the Auto Reduction option.
	Overlap When Split	
Acting Print	On(Split to Pages)	Select to split large incoming faxes across multiple sheets.
	On (Reduce to Fit)	Select to reduce the size of large received faxes to fit on the paper size in the selected paper source.
	Off	Select to print large incoming faxes at their original size on multiple sheets, if necessary.
Auto Rotation	On	If you have loaded A5-size paper, select On to rotate landscape-oriented incoming faxes so that they print correctly on the paper.
	Off	
Add Reception Information	On	Select On to include the date, time, the sender's information, and a page number in the header of your incoming faxes.
	Off	
2-Sided	On	Select On to print incoming faxes double sided. You can also select the Binding Margin .
	Off	

Setting	Options	Description
Print Start Timing	All Pages Received	Select to print incoming faxes after the product receives all of the pages of the document.
	First Page Received	Select to print incoming faxes as soon as the product receives the first page of the document.
Collation Stack	On	Select On to print incoming faxes so that the pages are stacked in the correct page order. (When the product is low on memory, this option may not be available.)
	Off	
Print Suspend Time	Off	Select On to set a time period to stop automatic printing of faxes or reports and save received faxes in the product's memory. (Make sure there is enough free memory before using this function.)
	On	
	Time to Stop	
	Time to Restart	
Quiet Mode	On	Select On to reduce noise during printing (printing speed may be reduced).
	Off	

Parent topic: [Selecting Advanced Fax Settings](#)

Report Settings - Fax

Set the options you want for fax reports.

Setting	Options	Description
Forwarding Report	Print on Error	Prints a report after forwarding a received document only if an error occurs
	Print	Prints a report after forwarding a received document
	Do Not Print	Does not print a report after forwarding a received document
Backup Error Report	On	Select On to print a report when a backup error for sending faxes occurs
	Off	

Setting	Options	Description
Fax Log	Off	Does not print a fax log
	On(Every 100)	Prints a fax log after every 100 fax jobs are completed
	On(Time)	Prints a fax log at a specified time. If the number of completed fax jobs exceeds 30, the fax log prints before the specified time.
Reception Report	Print on Error	Prints a report after receiving a fax only if an error occurs
	Print	Prints a report after receiving a fax
	Do Not Print	Does not print a report after receiving a fax
Attach Fax image to report	Off	Does not include an image on the Transmission Report
	On(Large Image)	Prints a Transmission Report that includes the upper part of the first page of the sent document
	On(Small Image)	Prints a Transmission Report that includes a reduced size of the entire first page of the sent document
Fax Log Layout	Combine Send and Receive	Prints a Transmission Report and a Reception Report on the same sheet when you print a fax log
	Separate Send and Receive	Prints a Transmission Report and a Reception Report on separate sheets when you print a fax log
Report Format	Simple	Prints a simple fax report
	Detail	Prints a fax report that includes error codes
Fax Log Output Method	Print	Prints fax reports
	Save to Memory Device	Saves fax reports to an inserted memory device. Select Create a folder to save fax data to create a folder on the inserted memory device.
	Forward	Forwards fax reports to a specified destination

Parent topic: [Selecting Advanced Fax Settings](#)

Security Settings - Fax

Set the security options you want to use for fax data.



Setting	Options	Description
Direct Dialing Restrictions	Off	Does not restrict dialed fax numbers.
	On	Allows faxing only to numbers stored in the contacts list or history.
	Enter Twice	Requires you to enter fax numbers twice to prevent errors.
Broadcasting Restrictions	Off	Select On to allow only one fax number to be entered as the recipient
	On	
Confirm Address List	Off	Selects whether or not to display a recipient confirmation screen before a fax is sent.
	On	
Backup Data Auto Clear	Off	Automatically erases sent or received fax data from your product's memory.
	On	
Clear Backup Data	—	Deletes all sent or received fax data remaining in your product's memory; run this function if you are giving away or disposing of your product.

Parent topic: [Selecting Advanced Fax Settings](#)

Setting Up the Fax Utility - Windows

You can set up the FAX Utility for Windows for use with your product.

Note: Before using the FAX Utility for Windows, make sure you have set up the fax features on your product using the product control panel. Also first confirm that you can send and receive faxes using the control panel.

- Do one of the following:
 - Windows 11:** Click , then search for **EPSON Software** and select it.
 - Windows 10:** Click  and select **EPSON Software**.
 - Windows 8.x:** Navigate to the **Apps** screen.
 - Windows (other versions):** Click  or **Start > Programs** or **All Programs > EPSON Software**.
- Select **FAX Utility**.

The first time you use the FAX Utility, you see this introduction window:

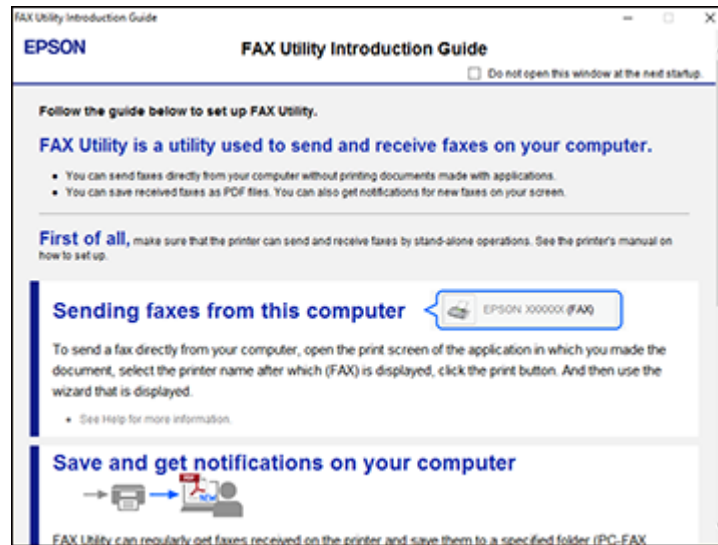

3. Read about the FAX Utility and click **Return to the main window** at the bottom of the window.

You see this window:

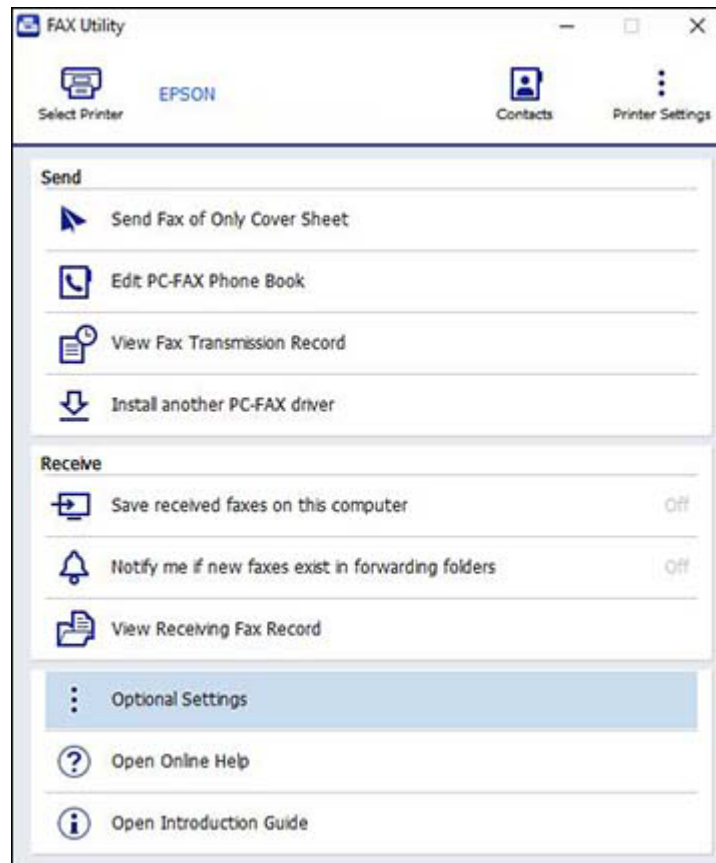

4. Click **Select Printer** and follow the on-screen instructions to transfer your product's fax settings to the FAX Utility.

Note: For detailed information, click **Help** or **Open Online Help**.

Parent topic: [Setting Up Fax Features](#)

Setting Up Contacts and Contact Groups

You can set up a list of contacts and their fax numbers so you can quickly select them for faxing. You can also set up contact groups to send a fax message to multiple contacts.

Note: Contacts can be locked by an administrator. If you cannot access or change contacts, contact your administrator for assistance.

[Creating a Contact](#)

[Editing or Deleting a Contact](#)

[Creating a Contact Group](#)



[Editing or Deleting a Contact Group](#)

Parent topic: [Faxing](#)

Creating a Contact

You can create a list of contacts to save frequently used fax numbers.

Note: You can create up to 2,000 contacts and contact groups combined.

1. Press the  home button, if necessary.
2. Select **Fax**.
3. Select the **Recipient** tab. Enter the administrator password, if necessary.
4. Select the  icon.
5. Select **Add Contact**.
6. Select the registry number you want to use for the contact you are adding.
7. Select the **Name** field, use the displayed keyboard to enter the contact name (up to 30 characters), and select **OK**.
8. Select the **Index Word** field, use the displayed keyboard to enter a word to use when searching for an entry (up to 30 characters), and select **OK**.

Note: This field is automatically populated after you enter the name. This field is optional.

9. Select the **Fax Number** field, and use the numeric keypad on the LCD screen or the buttons on the product to enter the fax number. You can enter up to 64 characters. Select **OK** when you are done.

Note: If necessary, enter an outside line access code (such as **9**) at the beginning of the fax number. If the access code has been set up in the **Line Type** setting, enter the **#** pound sign instead of the code.



Note: If you are using an IP fax destination, select **IP-FAX** as the **Line Type** and select **Close**.

10. Set the **Fax Communication Mode**, **Subaddress**, and **Password** settings, if necessary.
11. Set **Assign to Frequent Use** to **On** if you want the contact to appear on the **Frequent** tab.
12. Select the **Category Name** setting and enter the name of a category, if necessary. Select **OK** when you are done.
13. Select **OK**.

Parent topic: [Setting Up Contacts and Contact Groups](#)

Editing or Deleting a Contact

You can edit or delete any of the contacts on your list.



1. Press the  home button, if necessary.
2. Select **Fax**.
3. Select the **Recipient** tab. Enter the administrator password, if necessary.
4. Select the  icon next to the contact you want to edit or delete.
5. Do one of the following:
 - To delete the contact, select **Delete** and select **Yes** on the confirmation screen.
 - To edit the contact, select **Edit**, select the item you want to change, enter the correct information, and select **OK**. When you are finished editing, select **OK**.

Parent topic: [Setting Up Contacts and Contact Groups](#)

Creating a Contact Group

You can create a group of contacts so that you can easily send faxes to multiple recipients.

Note: You can create up to 2,000 contacts and contact groups combined.

1. Press the  home button, if necessary.
2. Select **Fax**.
3. Select the **Recipient** tab. Enter the administrator password, if necessary.
4. Select the  icon.
5. Select **Add Group**.
6. Select the registry number you want to use for the group you are adding.
7. Select the **Group Name** field, use the displayed keyboard to enter the group name (up to 30 characters), and select **OK**.
8. Select the **Index Word** field, use the displayed keyboard to enter a word to use when searching for a group (up to 30 characters), and select **OK**.



Note: This field is automatically populated after you enter the group name. This field is optional.

9. Select **Contact(s) Added to the Group**.
You see your contacts list.
10. Select each contact you want to include in your group.
Each selected contact is highlighted.
11. Select **Close**.
12. Set **Assign to Frequent Use** to **On** if you want the group to appear on the **Frequent** tab.
13. Select **OK**.

Parent topic: [Setting Up Contacts and Contact Groups](#)

Editing or Deleting a Contact Group

You can edit an existing contact group to add or delete entries. You can also delete the entire contact group.

1. Press the  home button, if necessary.
2. Select **Fax**.
3. Select the **Recipient** tab. Enter the administrator password, if necessary.
4. Select the  icon next to the group you want to edit or delete.

5. To edit the group, select **Edit**.
6. Select **Contact(s) Added to the Group**.
You see a list of the contacts in your group.
7. Select the contact you want to add or delete.
Each selected contact is highlighted.
8. Select **Close**.
9. Select **OK**.

Parent topic: [Setting Up Contacts and Contact Groups](#)

Sending Faxes

See these sections to send faxes using your product.

- [Sending Faxes from the Product Control Panel](#)
- [Sending Faxes Using the Fax Utility - Windows](#)
- [Sending Faxes Using the Fax Utility - Mac](#)
- [Sending IP Faxes Using the Control Panel](#)

Parent topic: [Faxing](#)

Sending Faxes from the Product Control Panel

See these sections to send faxes using the product's control panel.

- [Sending a Fax Using the Keypad, Contact List, or History](#)
- [Fax Sending Options](#)
- [Sending a Fax at a Specified Time](#)
- [Sending a Fax on Demand \(Polling Send/Box\)](#)
- [Sending a Fax on Demand \(Bulletin Board Box\)](#)
- [Sending a Stored Fax](#)
- [Dialing Fax Numbers from a Connected Telephone](#)

Parent topic: [Sending Faxes](#)

Sending a Fax Using the Keypad, Contact List, or History



You can send a fax from your product control panel by entering the fax number, or selecting the number from either the contact list or fax history.

Note: You can send a black-and-white fax to up to 200 recipients at a time, or send a color fax to one recipient at a time. If your recipient's fax machine does not print in color, your fax is automatically sent in black-and-white.

Note: The product can queue up to 50 black-and-white fax jobs. You can check or cancel fax jobs in the queue from the Job/Status screen.

1. Place your original on the product for faxing.
2. Press the  home button, if necessary.
3. Select **Fax**.
4. Do one of the following to select fax recipients:
 - Select **Enter Directly** and enter a fax number. Select **OK** when done. To add another fax number, repeat the same steps.

Note: If direct dialing has been restricted, you can only select the number from the contact list or fax history. If necessary, enter an outside line access code (such as 9) at the beginning of the fax number. If the access code has been set up in the **Line Type** setting, enter the # pound sign instead of the code. If your fax number requires a brief pause, select the  icon to insert a pause symbol (–).

- Select **Recipient** to display the contact list. Select one or more contacts (select the contact again to deselect it). You can also select the  icon to search for recipients by name or index word. Select **Close** when you are finished.
- Select the  icon to display the sent fax history.

Note: To delete entered recipients, select the **Enter Recipient** field, select the recipient you want to delete, and select **Remove**.

5. If you need to change any fax settings, select **Fax Settings** and select your settings.

6. If you want to preview your fax in black-and-white on the LCD, press the  **Preview** icon. (If the preview looks incorrect, select **Cancel**, reposition the document or change the fax settings, and repeat this step.)

Note: If **Fax Preview Display Time** is enabled and you do not touch the preview screen for 20 seconds, your product sends the fax automatically. You cannot preview images when the Direct Send setting is turned on.

7. If you want to save your fax settings for later use, select the  icon and add a new entry.
8. Select the **Send** icon.

Note: To cancel faxing, select **Stop** or **Cancel**. You can also cancel the job or check the job status from the Job/Status screen.

Your product scans your original and prompts you to place additional pages, if necessary.

After scanning your originals, your product dials the number and sends the fax.

Note: Your product does not save sent color faxes to its memory. If the **Save Failure Data** option is enabled, faxes that failed to be sent are stored to the product's memory and you can resend them from the Job/Status screen.

Parent topic: [Sending Faxes from the Product Control Panel](#)

Related references

[Fax Sending Options](#)

Fax Sending Options

While sending a fax, you can select **Fax Settings** and select these options.

Setting	Options	Description
Original Size (Glass)	Various sizes	Sets the size for a document placed on the scanner glass
Original Type	Text	Specifies the document type of your originals and adjusts the quality of your copies
	Text & Image	
	Photo	

Setting	Options	Description
Color Mode	Color	Selects whether to scan images in color or black and white
	B&W	
Resolution	Standard	Adjusts the scan resolution and print quality of outgoing faxes
	Fine	
	Super Fine	
	Ultra Fine	
Density	Varying levels	Select from various density levels.
Remove Background	Auto	Automatically removes any background color on scanned images
	Varying levels available	Lets you select from various levels of background color adjustment
Sharpness	Varying levels available	Adjusts the sharpness level of outgoing faxes
ADF 2-Sided	Off	Select On to enable 2-sided faxing from the ADF. The Direct Send setting and color faxing are disabled when you turn on this setting.
	On	
ADF Continuous Scan	Off	Select On to have the product to ask if you want to scan another page after a document in the ADF has finished scanning
	On	
Direct Send	Off	Select On to send black-and-white faxes to a single recipient as soon as the connection is made, without saving the scanned image to memory. You cannot use this setting when sending a color fax or sending a fax to multiple recipients.
	On	
Priority Send	Off	Select On to send the current fax before other faxes waiting to be sent
	On	
Send Fax Later	Off	Select On to send the current fax at a selected time
	On	

Setting	Options	Description
Add Sender Information	Off	Includes a header, your phone number, or a destination list in the selected location on your outgoing faxes
	Outside of Image	
	Inside of Image	
Notify Send Result	Off	Sends a notification to the selected email address when an outgoing fax is sent
	On	
Transmission Report	Print on Error	Selects when or if to print transmission reports
	Print	
	Do Not Print	
Backup	Off	Saves a copy of the scanned fax to the selected email address or network folder/FTP location
	On	

Parent topic: [Sending Faxes from the Product Control Panel](#)

Sending a Fax at a Specified Time

You can send a fax at a time of your choice.

Note: Make sure the product's date and time settings are correct. You can only send faxes in black-and-white when you use this option.

1. Place your original on the product for faxing.
2. Press the  home button, if necessary.
3. Select **Fax**.
4. Enter a fax number or select a number from the **Frequent**, **Recipient** or **Recent** lists.
5. Select **Fax Settings**.
6. Select **Send Fax Later**.
7. Select **On**.
8. Select **Time**, use the displayed keypad on the LCD screen to enter your desired time, and select **OK**.

9. Select the **Send** icon.

Note: To cancel faxing, select **Stop** or **Cancel**.

After scanning your originals, your product dials the number and sends the fax at the specified time.

Note: If the product is turned off at the specified time, the fax is sent when it is powered on.

Parent topic: [Sending Faxes from the Product Control Panel](#)

Related references

[Fax Sending Options](#)

Sending a Fax on Demand (Polling Send/Box)

You can store one scanned document (up to 200 black-and-white pages) and have it sent automatically when another fax machine requests it. Other fax users can receive the document by calling your fax number and using the polling receive function on their fax machines.

1. Place your original on the product for faxing.
2. Press the  home button, if necessary.
3. Select **Menu > Fax Box**.
4. Select **Polling Send/Board**.
5. Select **Polling Send**.
6. Review the displayed Polling Send Box settings. If you need to make changes, select **Settings**. Make any necessary changes and select **OK**.
7. Select **Add Document**.
8. Review the displayed Fax Settings. Make any necessary changes.
9. Select the **Store** icon.

Your document is scanned and stored until you overwrite or delete it.

You can store only one document at a time. Subsequent documents overwrite the existing document. You can also delete a stored document from the Job/Status screen.

Parent topic: [Sending Faxes from the Product Control Panel](#)

Related references

[Fax Sending Options](#)

Sending a Fax on Demand (Bulletin Board Box)

You can store up to 10 scanned documents (of up to 200 black-and-white pages) and have them sent automatically when another fax machine requests it. Other fax users can receive the document by calling your fax number and using the polling receive function on their fax machines. The requesting fax machine must support the subaddress/password feature.

1. Place your original on the product for faxing.
2. Press the  home button, if necessary.
3. Select **Menu > Fax Box**.
4. Select **Polling Send/Board**.
5. Select one of the boxes named **Unregistered Bulletin Board**.

Note: If a password entry screen is displayed, enter the password.

6. Enter information for the following settings:
 - Enter a name in the **Name (Required)** setting.
 - Enter a subaddress in the **Subaddress(SEP)** setting.
 - Enter a password in the **Password(PWD)** setting.
7. Make the appropriate settings such as **Notify Send Result** .

Note: If you set a password in **Box Open Password**, you will be asked to enter the password from the next time you open the box.

8. Select **OK** to apply the settings.
9. To store a document in a bulletin board box, select **Fax Box > Polling Send/Board**.
10. Select a registered bulletin board box. If the password entry screen is displayed, enter the password to open the box.
11. Select **Add Document**.
12. Review the displayed Fax Settings. Make any necessary changes.
13. Select the **Store** icon.

Your document is scanned and stored until you overwrite or delete it.

You can store only one document at a time in a bulletin board box. Subsequent documents overwrite the existing document. You can also delete a stored document from the Job/Status screen.



Parent topic: [Sending Faxes from the Product Control Panel](#)

Related references

[Fax Sending Options](#)

Sending a Stored Fax

You can store up to 200 pages of a single black-and-white scanned document and up to 200 documents in the **Stored Documents** area of the **Fax Box**. (Depending on the size of saved documents, you may not be able to save 200 documents.)

1. Place your original on the product for faxing.
2. Press the  home button, if necessary.
3. Select **Fax**.
4. Select **Menu**.
5. Select **Store Fax Data**.
6. Select any other fax settings as necessary and select the **Store** icon.
Your document is scanned, stored, and briefly previewed.
7. When you are ready to send the document, press the  home button, if necessary, and select **Fax Box**.
8. Select **Stored Documents**.
9. Select the stored fax job you want to send.
10. Select the **Send** icon.

You can store only one document at a time. Subsequent documents overwrite the existing document.

Parent topic: [Sending Faxes from the Product Control Panel](#)

Dialing Fax Numbers from a Connected Telephone

If you have connected a telephone to the **EXT** port on your product, you can send a fax by dialing the fax number from the connected telephone. If the recipient's phone number and fax number are the same, you can speak to the recipient before sending the fax.

1. Place your original on the product for faxing.
2. Press the  home button, if necessary.
3. Dial the fax number from the connected telephone. Speak to the recipient if necessary.

Note: If you are using a pre-paid calling card, enter the number and password required to use the card before entering the destination fax number.

4. Select **Fax** on the LCD screen.
5. Select **Fax Settings** and select any settings as necessary.

Note: Your product now communicates with the recipient's fax machine. Do not hang up the telephone.

6. When you hear a fax tone, select the **Send** icon to start sending the fax.

Note: If your recipient's fax machine does not print in color, your fax is automatically sent in black-and-white.

7. Hang up the telephone.

Parent topic: [Sending Faxes from the Product Control Panel](#)

Related references

[Fax Sending Options](#)

Sending Faxes Using the Fax Utility - Windows

You can send a fax from a printing program in Windows. You can fax up to 100 pages at a time, including a cover sheet.

1. Open the file you want to fax and select the print command.

You see a window like this:

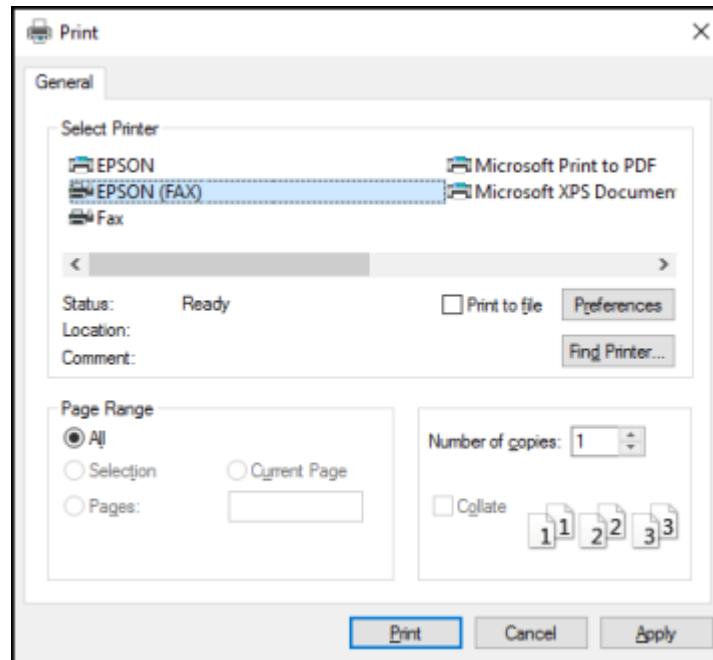

2. Select your product with the **FAX** option as the printer.
3. To change the Paper Size, Orientation, Color, Image Quality, or Character Density settings, click the **Preferences** or **Properties** button.

Note: If you see a **Setup**, **Printer**, or **Options** button, click it. Then click **Preferences** or **Properties** on the next screen. For more information about selecting fax print settings, click **Help**.

4. Select the Page Range as necessary. (Leave the Number of copies set to 1.)
5. Click **Print** or **OK**.

If you're faxing for the first time, you see a window like this one:

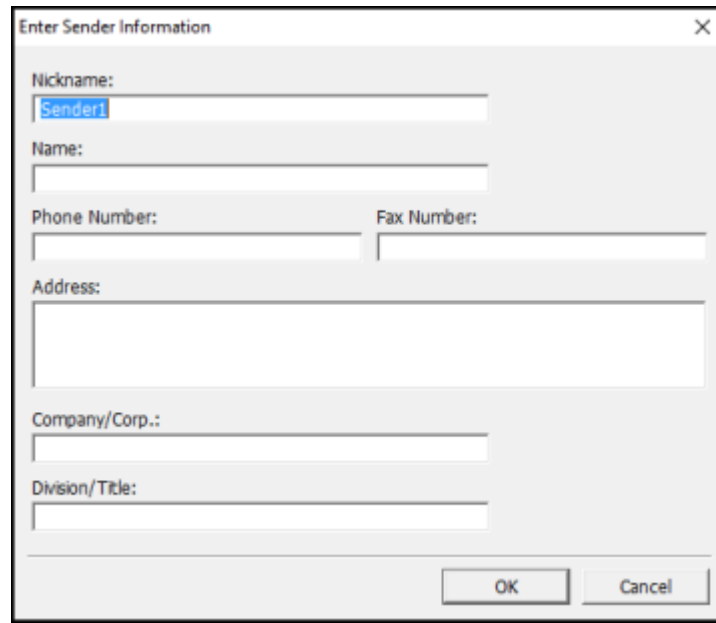

The image shows a dialog box titled "Enter Sender Information" with a close button (X) in the top right corner. The dialog contains several input fields: "Nickname:" with the text "Sender1" entered; "Name:" which is empty; "Phone Number:" and "Fax Number:" which are empty; "Address:" which is a large empty text area; "Company/Corp.:" which is empty; and "Division/Title:" which is empty. At the bottom right, there are two buttons: "OK" and "Cancel".

6. Enter your sender information so that recipients can identify the origin of the fax. Then click **OK** to save the sender information.

You see a window like this:

Recipient Settings (1 / 3)

Recipient List: Recipient Total: 0

Name/Group Name	Fax Number	Company/Corp.	Division/Title
-----------------	------------	---------------	----------------

Add Delete

Phone Book Manual Dial

Name: Fax Number:

Title:

Company/Corp.: Division/Title:

Save to Phone Book... Clear

< Back Next > Cancel Help

7. Enter the recipient's name and fax number or select a recipient from the phone book, then click **Next**.

Note: For detailed instructions on using the Epson FAX Utility, click **Help**.

8. Select a cover sheet and enter a subject and message, then click **Next**.
9. Click **Send** to transmit your fax.

Parent topic: [Sending Faxes](#)

Sending Faxes Using the Fax Utility - Mac

You can send a fax from a Mac printing program using the FAX Utility. You can fax up to 100 pages at a time, including a cover sheet.

1. Open the file you want to fax.
2. Select the print command in your application.

Note: You may need to select a print icon on your screen, the **Print** option in the **File** menu, or another command. See your application's help utility for details.

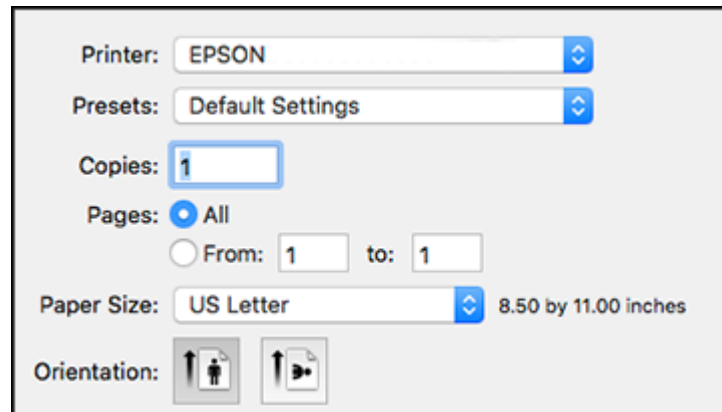

The image shows a print settings dialog box with the following controls:

- Printer:** A dropdown menu set to "EPSON".
- Presets:** A dropdown menu set to "Default Settings".
- Copies:** A text input field containing the number "1".
- Pages:** Radio buttons for "All" (selected), "From: 1 to: 1", and "From: 1 to: 1".
- Paper Size:** A dropdown menu set to "US Letter" with the dimensions "8.50 by 11.00 inches" displayed.
- Orientation:** Two icons: one for portrait orientation and one for landscape orientation.

3. Select your product **FAX** option as the **Printer** setting.
4. Select the number of pages you are faxing as the **Pages** setting.

Note: Leave the **Copies** setting set to 1.

5. Select **Recipient Settings** from the pop-up menu.

You see this window:

Recipient Settings

Recipient List:

Name	Company/Corp.	Fax Number
------	---------------	------------

Add:

Name:

Company/Corp.:

Fax Number:

A hyphen (-) is available only at the beginning of the phone number because it acts as a pause in dialing.

External Access Prefix:

Cancel Fax

6. Do one of the following to choose your recipient:
 - Select a name or group from the **Recipient List**.
 - Enter a name, company, and fax number and click the **+** button.
 - Click the  icon and select a recipient from your address book.
7. Select **Fax Settings** from the pop-up menu.

You see this window:

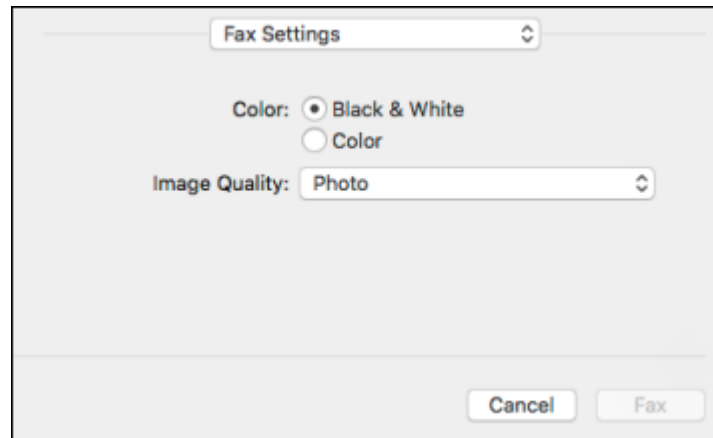

8. Select the **Color** and **Image Quality** settings you want to use for your fax.
9. Click **Fax**.

Parent topic: [Sending Faxes](#)

Sending IP Faxes Using the Control Panel

IP fax is a fax feature that sends and receives data over an IP network. You can send and receive between IP fax-compatible devices on an intranet or to and from G3 fax-compatible devices connected to telephone lines using a VoIP gateway. Note that there is a communication cost for the section from the VoIP gateway to the destination. (This is therefore a pay-as-you-go system based on distance/time).

Note: The IP fax feature requires a registered license key.

1. Place the originals.
2. Select **Fax** on the printer home screen.
3. Specify the recipients to send the fax to on the **Recipient** tab.

To enter the destination manually, select **Enter Directly**, and then from **Select Line**, select the **IP-FAX** line. Enter the destination directly using the numerical keypad on the screen

Note:

- You cannot directly enter a destination that contains characters that cannot be entered using the numeric keypad. Register the address to your contacts list in advance, and then specify the destination from the contacts list.
 - When **Security Settings in Direct Dialing Restrictions** is enabled, you can only select fax recipients from the contacts list or the sent fax history. You cannot manually enter the destination.
 - You can send faxes when **Transmission Setting By Line** is set to **Sending and Receiving** or **Sending Only**. You cannot send faxes when you select a line that is set to receive faxes only.
4. Select the **Fax Settings** tab, and then make settings such as the resolution and the sending method as necessary.
 5. Select the **Send** icon.

Your product scans your original and prompts you to place additional pages, if necessary.

After scanning your originals, your product dials the number and sends the fax.

[IP Fax Destination Examples](#)

Parent topic: [Sending Faxes](#)

IP Fax Destination Examples

Enter the destination in a format that matches your method for sending IP faxes.

Transmission Method		Recipient Format
Over an intranet (LAN)	When not using a SIP server	Enter the Main Unit URI (SIP URI format) set for the destination fax machine. <ul style="list-style-type: none">• Example 1: 1111@host.local• Example 2: User1@192.168.1.1• Example 3: User1@[2001:0db8::1234:5678:90ab:cdef]
	When using a SIP server	Enter the SIP user name for the Main Unit URI (SIP URI format) set for the destination fax machine. <ul style="list-style-type: none">• Example 1: 1111• Example 2: User1
G3 fax device (through a VoIP gateway)		Fax number Example: 0312345678

Parent topic: [Sending IP Faxes Using the Control Panel](#)

Receiving Faxes

See these sections to receive faxes with your product.

[Fax Reception](#)

[Receiving Faxes Automatically](#)

[Receiving Faxes Manually](#)

[Forwarding Received Faxes](#)

[Viewing a Fax on the LCD Screen \(Using the Fax Box\)](#)

[Receiving a Fax by Polling](#)

Parent topic: [Faxing](#)

Fax Reception

Your product will automatically receive and print faxes when you set the Receive Mode to **Auto**.

If you connected a telephone to your product so you can use the same phone line for faxes and voice calls, you can also set your product to receive faxes manually. This allows you to check for a fax tone using the telephone and press a button on your product to receive the fax.

Make sure to load paper in your product and select your fax settings before receiving a fax.

Parent topic: [Receiving Faxes](#)

Receiving Faxes Automatically

To receive faxes automatically, make sure Receive Mode is set to **Auto** (the default setting for the product).

To change the Receive Mode if necessary, select **Settings > General Settings > Fax Settings > Basic Settings > Receive Mode**.

If an answering machine is connected, make sure the product's **Rings to Answer** setting is set higher than the number of rings your answering machine is set to answer a call. For example, if the answering machine is set to pick up on the fourth ring, set the product to pick up on the fifth ring or later.

Parent topic: [Receiving Faxes](#)

Receiving Faxes Manually

You can set up your product to receive faxes manually by setting the Receive Mode to **Manual**. This lets you check for a fax tone on the connected telephone before receiving a fax.

1. To change the Receive Mode, select **Settings > General Settings > Fax Settings > Basic Settings > Receive Mode** and select **Manual**.
2. When the connected telephone rings, answer the call.
3. If you hear a fax tone, select **Fax** on the LCD display.
4. Select **Send/Receive**.
5. Select **Receive**.
6. Select the **Receive** icon to start receiving the fax.
7. Hang up the telephone.

Parent topic: [Receiving Faxes](#)

Forwarding Received Faxes

You can forward received faxes to another fax machine, or convert the faxes into PDF documents and forward them to a shared folder on the network or to an email address. Forwarded faxes are deleted from the product's memory. Before using this feature, make sure the date and time are set correctly, the forwarding destination is set up in the contact list, and the email server settings are configured.

1. Press the  home button, if necessary.
2. Select **Settings > General Settings > Fax Settings > Receive Settings > Save/Forward Settings > Unconditional Save/Forward > Forward > Yes**.

You see a screen like this:

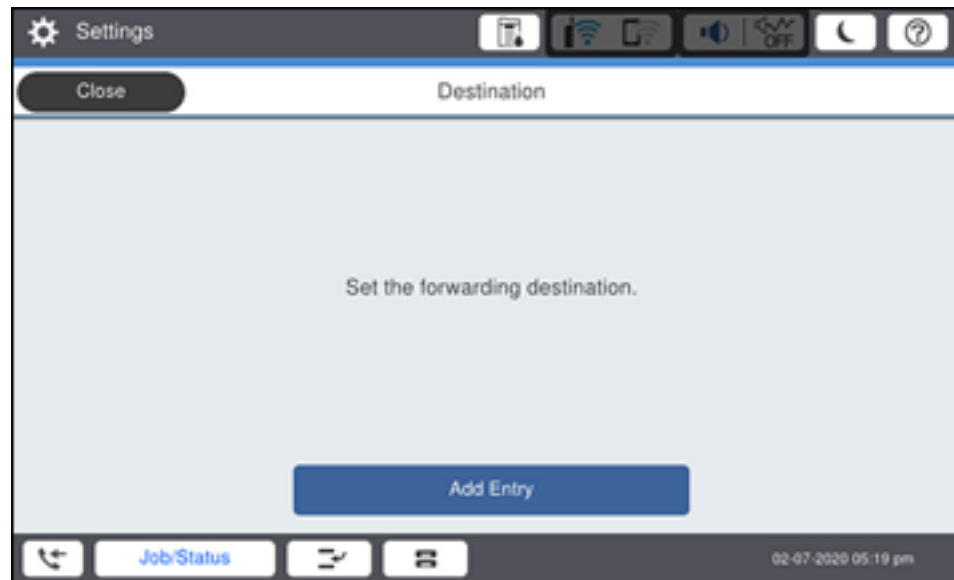

Note: If you want to print the fax automatically before forwarding it, select **Yes and Print**.

3. Select **Add Entry** and select the forwarding destinations from the contacts list.
4. When you are finished selecting your forwarding destinations, select **Close**.
5. Confirm the displayed forwarding destinations and select **Close**.
6. Select an **Options When Forwarding Failed** option to choose whether you want to print the faxes or save them in the printer's inbox if forwarding received faxes fails.

Parent topic: [Receiving Faxes](#)

Viewing a Fax on the LCD Screen (Using the Fax Box)

You can save received faxes in your product's memory and view them on the LCD screen.

Note: The Inbox can be locked by an administrator. If you cannot access the Inbox, contact your administrator for assistance.

1. Press the  home button, if necessary.

2. Select **Settings** > **General Settings** > **Fax Settings** > **Receive Settings** > **Save/Forward Settings** > **Unconditional Save/Forward**.

You see a screen like this:

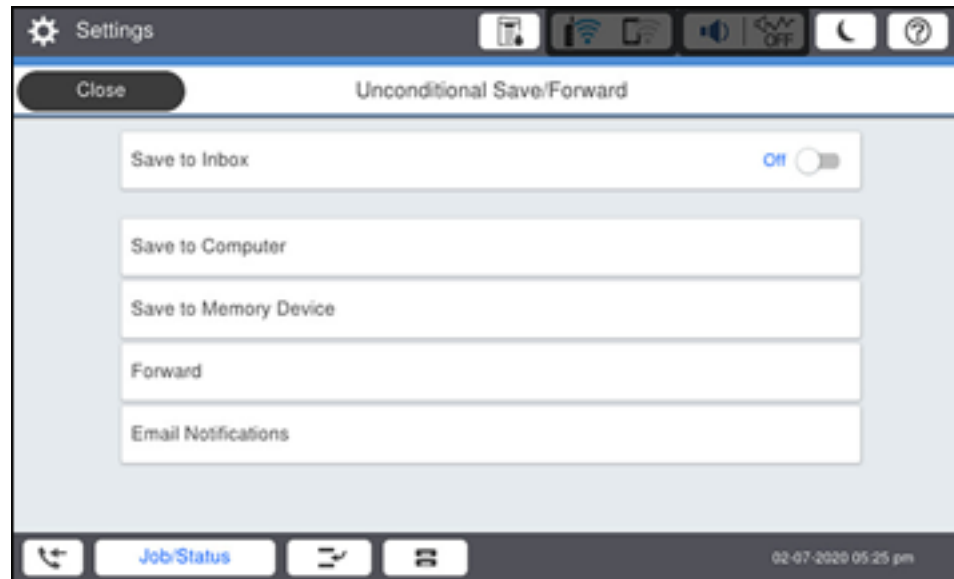

3. Set **Save to Inbox** to **On**.
4. Press the  home button.
5. Select **Fax Box**.
6. Do one of the following:
 - Select **Inbox/Confidential** to view received documents.
 - Select **Stored Documents** to view saved documents that have not been sent when **Store Fax Data** is set to **On**.
 - Select **Polling Send/Board** to view documents that are stored for fax polling.
7. Select the fax you want to view.

You see the fax displayed on the screen.
8. Select **Menu**.

9. Select one of the printing or deleting options, and follow the on-screen instructions.

Note: Delete faxes after you print or view them to prevent the product's memory from filling up. When the memory is full, you can only forward or print incoming faxes.

Parent topic: [Receiving Faxes](#)

Receiving a Fax by Polling

You can use polling to receive a fax from another fax machine (such as a fax information service).

Note: You cannot use polling to receive a fax from a fax information service that uses audio guidance.



1. Press the  home button, if necessary.
2. Select **Fax**.
3. Select **Menu**.
4. Select **Extended Fax**.
5. Set **Polling Receive** to **On**.
6. Select **Close**.
7. Enter the fax number you expect to receive the fax from.
8. Select the **Polling** icon to start receiving the fax.

Parent topic: [Receiving Faxes](#)

Checking Fax Status

You can check the status of current fax jobs, or faxes that have been received or sent on the product control panel.

1. Select **Job/Status**. Select the **Job Status** tab if necessary.
2. Do one of the following:
 - To check the status of current fax jobs, select the fax job you want to check.
 - To check the history of faxes that have been sent, received, or saved, select **Log** and select the job you want to check.

Note: If you see a numbered icon above the  icon on your product's LCD screen or the  fax reception light is flashing, received faxes have been temporarily saved to the product's memory.

Parent topic: [Faxing](#)

Printing Fax Reports

You can print several types of fax reports whenever necessary. You can also print the fax log printed automatically by turning on **Fax Log Auto Print**.

1. Press the  home button, if necessary.
2. Select **Fax**.
3. Select **Menu**.
4. Under **Fax Report**, select the fax report you want to print.

[Fax Report Options](#)

Parent topic: [Faxing](#)

Fax Report Options

Select the fax report or list you want to print.

Last Transmission

Print a report on the previous fax that was sent or received through polling.

Fax Log

View or print a report on recent fax transmissions.

Stored Fax Documents

Print a list of the fax jobs currently stored in the product's memory.

Fax Settings List

Print a list of the current fax communication settings.

Conditional Save/Forward List

Print a list of the current conditional save/forward settings.

Protocol Trace

Print a detailed report for the previous sent or received fax.

Parent topic: [Printing Fax Reports](#)

Using External USB Devices with Your Product

Follow the instructions here to work with an external USB device connected to your product.

[Connecting a USB Device](#)

[Viewing and Printing from the LCD Screen](#)

[Transferring Files on a USB Device](#)

Connecting a USB Device

Connect a USB device or its USB cable to the USB port on the front of the product.

To view instructions on connecting a USB device or cable, select , then select **How To > USB memory connection**.

Perform the steps in reverse order to remove the external USB device.

Caution: If you remove the external USB device while operating the product, the data on the external USB device may be lost.

Note: Epson cannot guarantee the compatibility of your device. Make sure the files on the device are compatible with the product.

Parent topic: [Using External USB Devices with Your Product](#)

Viewing and Printing from the LCD Screen

See these sections to view and print photos or other files displayed on your product's LCD screen.

[Printing JPEG Photos](#)

[Printing TIFF and PDF Files](#)

Parent topic: [Using External USB Devices with Your Product](#)

Printing JPEG Photos

You can select JPEG photos for printing as you view them on the LCD screen.

1. Press the  home button, if necessary.
2. Select **Memory Device**.

3. Select **JPEG**.

Note: If you have more than 999 JPEG images on your device, the images are divided into groups, and you must first select the group you want to display.

4. Do one of the following to select your photos:

- In **Tile View**, select the thumbnail images of the photos you want to print.
- In **Single View**, select the thumbnail image of the photo you want to print, then press the left or right arrow buttons to scroll through and select additional photos, or select **Tile View** to return to the thumbnail image view and select additional photos.
- To select all photos, select the  icon and select **Select All Images**.

5. To change the print settings, select **Basic Settings** and select the necessary settings.

6. To adjust the photos (adjustments modify only your printed copies, not the original files), select **Advanced** and make the necessary adjustments.

7. Select **Copies** on the LCD screen and use the numeric keypad on the screen to select the number of copies (up to 9999).

8. When you are ready to print, select the **Print** icon.

Note: To save the file to the internal storage, select **Advanced > File Storing** and enter the file information. Select **Setting** to select whether or not to print the file as well.

To cancel printing, select **Stop** or **Cancel** on the LCD screen, then select **Cancel Print From Memory Device** to confirm.

[Print Setting Options - JPEG Mode](#)

Parent topic: [Viewing and Printing from the LCD Screen](#)

Print Setting Options - JPEG Mode

Select the print settings you want to use when printing a JPEG from a USB device.

Note: Not all options or settings may be available, depending on the file format.

Basic Settings

Print settings	Available options	Description
Paper Setting	Various paper size and type settings	Select the paper source that you want to use.
Layout	1-up	Print one photo per page.
	20-up	Print 20 photos per page.
	Index	Print numbered photo thumbnails with date information.
Fit Frame	On	Automatically crops the photo to fit into the selected photo layout.
	Off	Turns off automatic cropping.
B&W	—	Prints a color photo in black and white.
Color	—	Prints the photo in color.

Advanced settings

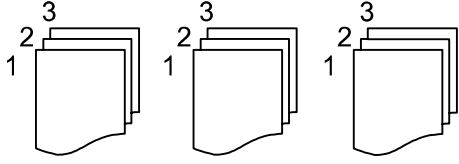
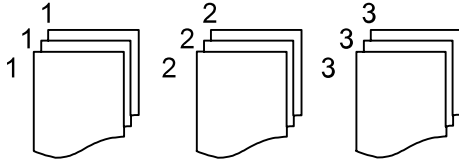
Print settings	Available options	Description
Finishing	Collate (Page Order)	Select to print multiple copies of a multi-page document in ordered sets. 
	Group (Same Pages)	Select to print multiple copies of a multi-page document in unordered groups. 
	Eject Paper	Choose if you want printouts ejected offset for each set of copies.
	Staple*	Select the staple location.
	Punch**	Select the punch hole location.
Fold	Half Fold	Half Fold: Enables printing with half folds Sheets per Fold: Specifies the number of pages in each folded section Print Mode: Selects whether to print on the outside or inside of the half folded paper
	Tri Fold	Tri Fold: Enables printing with half folds Sheets per Fold: Specifies the number of pages in each folded section Print Mode: Selects whether to print on the outside or inside of the half folded paper Binding: Sets the binding position

Print settings	Available options	Description
Fix Photo	Various settings	Automatically adjusts the brightness, contrast, and saturation of the photo based on the setting that is selected.
	Enhance Off	Turns off automatic adjustments.
Fix Red-Eye	Off	Automatically fixes the red-eye effect in photos; see Note below.
	On	
Date	Various date formats	Prints the date the photo was taken on the photo in the format you select.
File Storing	Setting	Select the file storage settings you want to use.
	Folder (Required)	
	File Name	
	File Password	
	User Name	

* Displayed when the optional finisher unit is installed.

** Displayed when the optional punch unit is installed.

Note: Fix Red-Eye makes corrections to printouts, not the original photo files. Depending on the type of photo, parts of the image other than the eyes may be corrected.

Parent topic: [Printing JPEG Photos](#)

Printing TIFF and PDF Files

You can select and print TIFF or PDF files from a USB flash drive.

1. Press the  home button, if necessary.
2. Select **Memory Device**.
3. Select **TIFF** or **PDF**.

You see a list of the available files.

4. Select the file you want to print.

Note: To view information about the file, select the arrow icon at the end of the file name.

5. Do the following as necessary:

- To print more than one copy, select **Copies** on the LCD screen and use the numeric keypad on the screen to select the number of copies (up to 9999).
- To change the print settings, select **Basic Settings** or **Advanced** and select the necessary settings.

6. When you are ready to print, select the **Print** icon.

Note: To save the file to the internal storage, select **Advanced > File Storing** and enter the file information. Select **Setting** to select whether or not to print the file as well.

To cancel printing, select **Stop** or **Cancel** on the LCD screen, then select **Cancel Print From Memory Device** to confirm.

[Print Setting Options - TIFF Mode](#)

[Print Setting Options - PDF Mode](#)

Parent topic: [Viewing and Printing from the LCD Screen](#)

Print Setting Options - TIFF Mode

Select the print settings you want to use when printing a TIFF from a USB device.

Note: Not all options or settings may be available, depending on the file format.

Basic Settings

Print settings	Available options	Description
Recent to old or Old to recent	—	Change the order of the photos displayed on the LCD screen.
Paper Setting	Various paper size and type settings	Select the paper source that you want to use.

Print settings	Available options	Description
Layout	1-up	Print one photo per page.
	20-up	Print 20 photos per page.
	Index	Print numbered photo thumbnails with date information.
Fit Frame	On	Automatically crops the photo to fit into the selected photo layout.
	Off	Turns off automatic cropping.
B&W	—	Prints a color photo in black and white.
Color	—	Prints a color photo in color.

Advanced settings

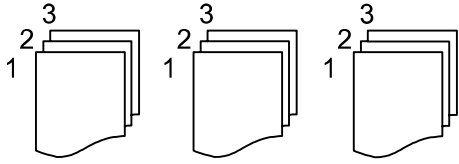
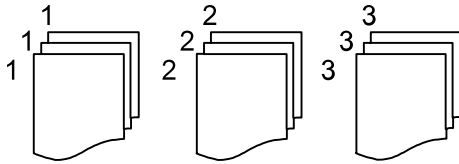
Print settings	Available options	Description
Finishing	Collate (Page Order)	Select to print multiple copies of a multi-page document in ordered sets. 
	Group (Same Pages)	Select to print multiple copies of a multi-page document in unordered groups. 
	Eject Paper	Select Shift Sort* to eject offset printouts for each set of copies.
	Staple*	Select the staple location.
	Punch**	Select the punch hole location.

Print settings	Available options	Description
Fold	Half Fold	<p>Half Fold: Enables printing with half folds</p> <p>Sheets per Fold: Specifies the number of pages in each folded section</p> <p>Print Mode: Selects whether to print on the outside or inside of the half folded paper</p>
	Tri Fold	<p>Tri Fold: Enables printing with half folds</p> <p>Sheets per Fold: Specifies the number of pages in each folded section</p> <p>Print Mode: Selects whether to print on the outside or inside of the half folded paper</p> <p>Binding: Sets the binding position</p>
Print Order	—	Select the printing order for multi-page documents.
Date	Various date formats	Prints the date the photo was taken on the photo in the format you select.
File Storing	Setting	Select the file storage settings you want to use.
	Folder (Required)	
	File Name	
	File Password	
	User Name	

* Displayed when the optional finisher unit is installed.

** Displayed when the optional finisher and the punch unit are installed.

Parent topic: [Printing TIFF and PDF Files](#)

Print Setting Options - PDF Mode

Select the print settings you want to use when printing a PDF from a USB device.

Note: Not all options or settings may be available, depending on the file format.

Basic Settings

Print settings	Available options	Description
Recent to old or Old to recent	—	Change the order of the documents displayed on the LCD screen.
Paper Setting	Various paper size and type settings	Select the paper source that you want to use.
2-Sided	Off	Two-sided printing is off.
	On	Two-sided printing is on.
	Binding Position	Select the binding position for the document.
Print Order	—	Select the printing order for multi-page documents.
B&W	—	Prints a color photo in black and white.
Color	—	Automatically detects whether the photo is in color or black and white.

Advanced settings

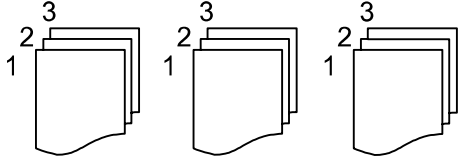
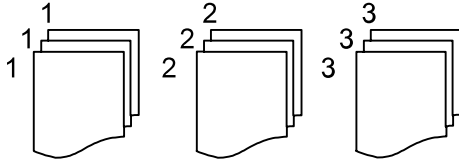
Print settings	Available options	Description
Finishing	Collate (Page Order)	Select to print multiple copies of a multi-page document in ordered sets. 
	Group (Same Pages)	Select to print multiple copies of a multi-page document in unordered groups. 
	Eject Paper	Select Rotate Sort to print alternate paper orientations and paper sources (make sure the Paper Setting is set to Auto for this option). Select Shift Sort* to eject offset printouts for each set of copies.
	Staple*	Select the staple location.
	Punch**	Select the punch hole location
Fold	Half Fold	Half Fold: Enables printing with half folds Sheets per Fold: Specifies the number of pages in each folded section Print Mode: Selects whether to print on the outside or inside of the half folded paper
	Tri Fold	Tri Fold: Enables printing with half folds Sheets per Fold: Specifies the number of pages in each folded section Print Mode: Selects whether to print on the outside or inside of the half folded paper Binding: Sets the binding position

Print settings	Available options	Description
File Storing	Setting	Select the file storage settings you want to use.
	Folder (Required)	
	File Name	
	File Password	
	User Name	

* Displayed when the optional finisher unit is installed.

** Displayed when the optional finisher and punch unit are installed.

Parent topic: [Printing TIFF and PDF Files](#)

Transferring Files on a USB Device

You can transfer files to and from a USB device inserted into the USB port on the front of your product.

[Setting Up USB Device Access](#)

Parent topic: [Using External USB Devices with Your Product](#)

Setting Up USB Device Access

Before you can access a USB device inserted into the USB port on the front of your product, you may need to enable the access setting.

Caution: Remove the USB device before you change this setting or you may lose data from the device.

Note: These settings can be locked by an administrator. If you cannot access these settings, contact your administrator for assistance.

1. Press the  home button, if necessary.
2. Select **Settings** > **General Settings** > **Printer Settings** > **Memory Device**.
3. Select **Enable**.

Parent topic: [Transferring Files on a USB Device](#)

Using Your Product's Internal Storage

You can store files to the product's internal hard drive to quickly and easily print, email, or transfer them later without using a computer.

Follow the instructions here to access and save files to the product's internal hard drive.

[Storage Folder Types](#)

[Creating Shared Folders](#)

[Printing a Stored File](#)

[Saving Groups for Printing from Storage](#)

[Editing or Deleting a Saved Group](#)

[Saving Stored Files to an External USB Device](#)

[Emailing Stored Files](#)

[Saving Stored Files to a Network Folder](#)

[Saving Stored Files to Cloud Services](#)

[Storage Menu Options](#)

[Searching for Folders and Files](#)

[Deleting Folders and Files from Storage](#)

[Changing the Storage Period of Files](#)

[Restricting Shared Folder Access](#)

Storage Folder Types

You can store files in folders on the product's hard drive and access them later. The table below outlines the different types of available storage folders.

Type of folder	Description
Default folder	The default folder is named Shared Folder . You cannot rename, set a password for, or delete this folder. All users can store files in the default folder. Files in the default folder can be password-protected to limit access.
User-created shared folders	Users can create up to 199 individual folders for storage. Unless a password is set for the created folder, any user can access this folder, along with any files that are not password-protected. Users can set a password for the created folder and any files in it.



Type of folder	Description
Personal folder	If the product is equipped with user authentication, an administrator can create personal folders for specific users. A personal folder is only displayed if it belongs to the user that is logged in, and only that user can store and access the files. Only one personal folder can be created per user.

Parent topic: [Using Your Product's Internal Storage](#)

Creating Shared Folders

Administrators and users can create shared folders using your product's hard drive.

Note: Users can only create shared folders when the **Settings > General Settings > Storage Settings > Shared Folder Access Control > Access** setting is set to **Allowed** and the **Operation Authority** setting is set to **User**.

1. Press the  home button, if necessary.
2. Select **Storage** and select the  icon.
3. Set the following items:
 - **Folder Number:** Unused folder numbers are assigned automatically.
 - **Folder Name (Required):** Enter a folder name up to 30 letters. Duplicate names are allowed.
 - **Folder Password:** Enter a password to save files to the folder, view the folder contents, or modify the folder. All users can access a shared folder if it does not have a password.
 - **Automatic File Delete Settings:** Enable the setting and select a value for **Period Until Deletion**. Files will be deleted after the time period expires since the last time the file was accessed. Users can only change this setting if the **Automatic Delete Setting Authority** setting is set to **User**.
4. Select **OK** to confirm.

Parent topic: [Using Your Product's Internal Storage](#)

Printing a Stored File

You can print a file saved in a storage folder.

Note: Some finishing options require optional equipment to be installed. If finishing settings are either missing or inactive, the printer may not have the appropriate options available.

1. Press the  home button, if necessary.
2. Select **Storage**.
3. Select the folder containing the file you want to print and select **Open**.
4. Select the file you want to print.
5. Select **Copies** and set the number of copies you want to print.

Note: If you want to print using a saved group, select **Print Settings**, then select **Advanced**. Select **Print Sets** and then select the group you want to use. Select **OK**.

6. If you want to make settings for saddle stitching or folding a booklet, select **Print Settings > Basic Settings** and enable 2-sided printing. Then set the **Finishing** setting to **Collate (Page Order)**, and enable the **Booklet** setting. Select **Saddle Stitch** or **Half Fold** and set any settings, as necessary. To split the number of pages with saddle stitching or folding, enable the **Split** setting and then set the number of pages to split in the **Sheets per Staple** or **Sheets per Fold** setting.

Note: Remove any booklets or paper from the booklet tray or you will not be able to start printing.

7. For other print options, do the following:
 - To fold each set of printouts, select **Print Settings > Basic Settings > Paper Setting** and select the paper source. Select the **Advanced** tab, then enable either the **Half Fold** or **Tri Fold** setting and specify any details as necessary.
 - To print with staples, select **Print Settings > Basic Settings > Finishing > Staple** and select a staple location.
 - To print with punched holes, select **Print Settings > Basic Settings > Finishing > Punch** and select a punch hole location.
 - To offset each printed copy, select **Print Settings > Basic Settings > Finishing > Eject Paper** and select **Shift Sort**.
8. Change any other print settings as needed.
9. Select the **Print** icon.

Parent topic: [Using Your Product's Internal Storage](#)

Saving Groups for Printing from Storage

You can save groups of frequently used print quantities and sets so that you can print a file without entering the number of copies each time. This is useful when you are printing a different number of copies for each set.

Note: You can save up to 12 print set groups with up to 60 subgroups in each. Print set groups are also accessible when copying.

1. Press the  home button, if necessary.
2. Select **Storage**.
3. Select the folder containing the file you want to print and select **Open**.
4. Select the file you want to print.
5. Select **Print Settings** and select the **Advanced** tab.
6. Select **Print Sets** and then select **Not Set** from the list.
7. Select **Register/Overwrite** and enter a group name.
8. Set the number of copies and sets on the **Copies & Sets** tab.
9. Select any other settings as necessary.
10. Select **OK** to save.

Parent topic: [Using Your Product's Internal Storage](#)

Editing or Deleting a Saved Group

You can edit or delete a print set group.

1. Press the  home button, if necessary.
2. Select **Storage**.
3. Select the folder containing the group you want to edit or delete and select **Open**.
4. Select a file and select **Print Settings > Advanced**.
5. Select **Print Sets** and then select the group you want to edit or delete from the list.
6. Do one of the following:
 - Select **Register/Overwrite** to edit the group and modify the **Copies & Sets** and **Finishing** settings as desired. Proceed to the next step.

- Select **Delete** to delete the group. You are done.
7. Select **OK** to save.

Parent topic: [Using Your Product's Internal Storage](#)

Saving Stored Files to an External USB Device

You can save a file in a storage folder to an external USB device connected to your product.

1. Press the  home button, if necessary.
2. Select **Storage**.
3. Select the folder containing the file you want to save to an external USB device and select **Open**.
4. Select the file.
5. Select **Send/Save > Storage to Memory Device**.
6. Change any save settings as necessary.
7. Select the **Save** icon.

Parent topic: [Using Your Product's Internal Storage](#)

Emailing Stored Files

You can email a file saved in a storage folder.

Note: Email server settings must be configured before you can send email.

1. Press the  home button, if necessary.
2. Select **Storage**.
3. Select the folder containing the file you want to print and select **Open**.
4. Select the file.
5. Select **Send/Save > Storage to Email**.
6. Select a contact or select **Keyboard** to enter the recipient's email address.
7. Set the save settings as necessary.
8. Select the **Send** icon.

Parent topic: [Using Your Product's Internal Storage](#)

Saving Stored Files to a Network Folder

You can save a file saved in a storage folder to a network folder.

Note: A network folder must already be set up. See the link below to set up a network folder.

1. Press the  home button, if necessary.
2. Select **Storage**.
3. Select the folder containing the file you want to print and select **Open**.
4. Select the file.
5. Select **Send/Save > Storage to Network Folder/FTP**.
6. Select the destination field and specify the destination by entering the folder path in the following format:
 - **SMB:** \\host\folder name
 - **FTP:** ftp://host name/folder name
 - **FTPS:** ftps://host name/folder name
 - **WebDAV (HTTPS):** https://host name/folder name
 - **WebDAV (HTTP):** http://host name/folder name
7. Set the save settings as necessary.
8. Select the **Save** icon.

Parent topic: [Using Your Product's Internal Storage](#)

Related tasks

[Creating a Shared Network Folder](#)

Saving Stored Files to Cloud Services

You can save a file saved in a storage folder to a cloud service.

Note: Epson Connect services must already be set up.

1. Press the  home button, if necessary.
2. Select **Storage**.
3. Select the folder containing the file you want to print and select **Open**.

4. Select the file.
5. Select **Send/Save > Storage to Cloud**.
6. Specify the destination.
7. Set the save settings as necessary.
8. Select the **Upload** icon.

Parent topic: [Using Your Product's Internal Storage](#)

Related tasks

[Setting Up Epson Connect Services](#)

Storage Menu Options

You can select the printing settings you want to use for your stored files.

Note: Not all options or settings may be available, depending on other settings.

Basic Settings

Printing option	Available settings	Description
Auto	—	Prints the document in the detected color of the original.
Color	—	Prints the document in color.
B&W	—	Prints the document in black and white.
Paper Setting	Various sources	Select the paper source that you want to use. If you select Auto , paper is fed automatically depending on the paper settings you selected for the paper sources.

Printing option	Available settings	Description
Reduce/Enlarge	Saved Settings	Applies settings you have previously made for saving to storage
	Auto	Automatically sizes the image to fit the paper size you selected.
	Actual Size	Prints the original at its full size.
	User-defined (mm)	Specifies the target size in millimeters.
	User-defined (%)	Specifies the amount of scaling in percentage for length and width
	Reduce to Fit Paper	Automatically decreases the size of the image by the percentage you select.
2-Sided	On	Select On for 2-sided printouts and then scroll down to select the orientation and binding edge for your printouts.
	Off	
Multi-Page	Single Page	Copies each page of the original onto an individual sheet.
	2-up	Copies multiple page documents onto one sheet. Scroll down and select the document orientation and layout order settings as necessary.
	4-up	

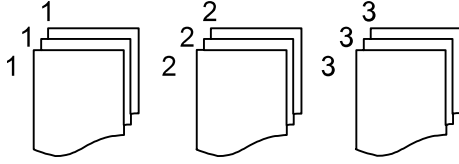
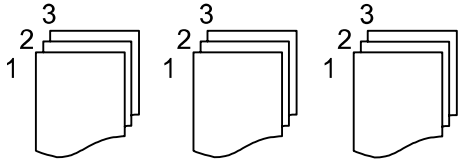
Printing option	Available settings	Description
Finishing	Group (Same Pages)	Select to print multiple copies of a multi-page document in unordered groups 
	Collate (Page Order)	Select to print multiple copies of a multi-page document in ordered sets 
	Eject Paper	Select Rotate Sort to stack printouts alternately in landscape and portrait orientations. Select Shift Sort* to offset each set of printouts.
	Staple*	Select a staple option to choose the staple location on the printouts.
	Punch**	Select a location for the punch holes.

Printing option	Available settings	Description
Booklet	On	Select On and then adjust settings as necessary when making a booklet from your printouts.
	Off	
	Booklet	<p>Binding: Sets the binding position</p> <p>Binding Margin: Specifies the binding margin in 1 mm increments from 0 to 50 mm.</p> <p>Cover: Allows you to add a cover to the booklet</p> <p>Paper Setting: Selects the paper source for the cover paper</p> <p>Front Cover: Specifies the settings for the front cover. If you want a blank cover, select Do Not Print</p> <p>Back Cover: Specifies the settings for the back cover. If you want a blank cover, select Do Not Print</p>
	Saddle Stitch*	<p>Saddle Stitch: Enables saddle stitching</p> <p>Sheets per Staple: Specifies the number of pages in each stapled section</p> <p>Split: Allows you to print separately</p> <p>Cover: Allows you to add a cover to the booklet</p> <p>Paper Setting: Selects the paper source for the cover paper</p>
Half Fold	<p>Saddle Stitch: Enables saddle stitching</p> <p>Sheets per Staple: Specifies the number of pages in each stapled section</p> <p>Split: Allows you to print separately</p> <p>Cover: Allows you to add a cover to the booklet</p> <p>Paper Setting: Selects the paper source for the cover paper</p>	

* Displayed when the optional finisher unit is installed.

** Displayed when the optional finisher and punch unit are installed.

Advanced settings

Printing option	Available settings	Description
Fold	Half Fold	<p>Half Fold: Enables printing with half folds</p> <p>Sheets per Fold: Specifies the number of pages in each folded section</p> <p>Split: Allows you to split copies when they are ejected</p> <p>Cover: Allows you to add a cover to the booklet</p> <p>Paper Setting: Selects the paper source for the cover paper</p> <p>Print Mode: Selects whether to print on the outside or inside of the half folded paper</p>
	Tri Fold	<p>Tri Fold: Enables printing with half folds</p> <p>Sheets per Fold: Specifies the number of pages in each folded section</p> <p>Print Mode: Selects whether to print on the outside or inside of the half folded paper</p> <p>Open Orientation: Selects the direction of the folds</p>
Cover & Slip Sheet	Cover	<p>Front Cover: Specifies the settings for the front cover. If you want a blank cover, select Do Not Print</p> <p>Back Cover: Specifies the settings for the back cover. If you want a blank cover, select Do Not Print</p>
	Slip Sheet	<p>Adjust these settings to insert slip sheets into your printouts.</p> <p>End of Job: Adds a sheet at the end of each copy of the job. If you have loaded paper for the slip sheets, select the paper source as the Paper Setting setting.</p> <p>End of Set: Adds a sheet at the end of each set. To insert the slip sheet after a certain number of pages, select Sheets per Set and enter a value. If you have loaded paper for the slip sheets, select the paper source as the Paper Setting setting.</p> <p>End of Page or Chapter: Allows you to insert slip sheets at individual pages. The setting values are saved and displayed in a list. Select the setting to edit, delete, or review the values.</p>

Printing option	Available settings	Description
Binding Margin	Off	Select On to adjust the margin, binding position, and orientation of the pages for 2-sided printing.
	On	
Reduce to Fit Paper	Off	Select On to automatically decrease the image by the percentage you select.
	On	
Print Sets	Off	Select On to print the document in groups of saved quantities and settings.
	On	
Output Tray	Face Down Tray	Select which output tray to use.
	Finisher Tray	
	Auto	
Stamp	Stamp	Select On to include stamps in your printout
	Type	Selects the stamp type
	Stamp Position	Selects the stamp position
	Print Page	Selects the page where the stamp appears
	Size	Controls the size of the stamp
	Print Color	Selects the color for the stamp
	Transparency	Controls the transparency of the stamp
Date Stamp	Date Stamp	Adds a date stamp to your printouts when enabled
	Date Format	Selects the date format
	Stamp Position	Selects the stamp position
	Size	Controls the size of the stamp
	Background	Controls whether the date stamp has a white background
Page Numbering	Off	Select On to print page numbers on your printouts and select the format settings as necessary.
	On	
Print Position Shift	Off	Select On and set the margins at the top and left of the paper to adjust the print position of the document.
	On	

Parent topic: [Using Your Product's Internal Storage](#)

Searching for Folders and Files

You can search for folders and files in storage using a folder name, folder number, file name, or user name.

1. Press the  home button, if necessary.
2. Select **Storage**.
3. Do one of the following:
 - To search for a folder, select the search field and use the on-screen keyboard to enter keywords, then select **OK**.
 - To search for a file, select the folder you want to search in and select **Open**. Select the search field and use the on-screen keyboard to enter keywords, then select **OK**.

Parent topic: [Using Your Product's Internal Storage](#)

Deleting Folders and Files from Storage

You can delete folders and files from your product's hard drive.

Note: Users can only delete shared folders when the **Access** setting for **Shared Folder Access Control** is set to **Allowed** and the **Operation Authority** setting is set to **User**.

1. Press the  home button, if necessary.
2. Select **Storage**.
3. Do one of the following:
 - To delete a folder, select the folder and select **Delete**. Enter the password, if necessary.

Note: Only administrators can delete folders that contain password-protected files.

- To delete a file, select the folder that contains the file, then select **Open**. Select the file and select **Delete**.

Note: You can select multiple files to be deleted.

- To delete all files in a folder, select the folder, then select **Open**. Select **Delete All**.

4. Select **Yes** to confirm.

Parent topic: [Using Your Product's Internal Storage](#)

Changing the Storage Period of Files

You can change the storage period for files before they are deleted from shared folders. By default, files are not deleted automatically.

You can also set the file storage period for individual folders by selecting the folder, selecting **Settings > Automatic File Delete Settings**, and adjusting any of the displayed settings.

Note: Users can only change the storage period when the **Access** setting in **Shared Folder Access Control** is set to **Allowed** and the **Automatic Delete Setting Authority** setting is set to **User**.

1. Press the  home button, if necessary.
2. Select **Settings > General Settings > Storage Settings > Shared Folder File Management**.
3. Do one of the following:
 - Enable **Automatic File Deletion** to set a period of time before files are automatically deleted from shared storage folders. Select **Period Until Deletion** and adjust the settings as desired.
 - Disable **Automatic File Deletion** to never delete files in shared storage folders.
 - To delete a file after printing or saving, enable the **Settings > General Settings > Storage Settings > Additional Action > Delete File after Output** setting. Enable the **Access Control** setting to display a checkbox on the File List that allows you to delete the file.

Parent topic: [Using Your Product's Internal Storage](#)

Restricting Shared Folder Access

You can set who has access to shared folders.

Note: If you cannot access or change this setting, contact your administrator for assistance.

1. Press the  home button, if necessary.
2. Select **Settings > General Settings > Storage Settings > Shared Folder Access Control > Operation Authority**.
3. Do one of the following:
 - Select **User** if you want any user to have shared folder access.

- Select **Administrator Only** if you want only the administrator to have shared folder access.

Parent topic: [Using Your Product's Internal Storage](#)

Replacing Ink Cartridges, Maintenance Boxes, and Cassette Rollers

When ink is expended, or the maintenance box and cassette rollers are at the end of their service life, you need to replace them. The maintenance box stores ink that gets flushed from the system during print head cleaning.

Note: Please dispose of your used Epson branded ink cartridges and maintenance boxes responsibly and in accordance with local requirements. If you would like to return your used ink cartridges and maintenance boxes to Epson for proper disposal, please go to [epson.com/recycle](https://www.epson.com/recycle) for more information.

[Ink Safety Precautions](#)

[Check Cartridge and Maintenance Box Status](#)

[Replacing Ink Cartridges and Maintenance Boxes](#)

[Replacing the Paper Feed Rollers](#)

[Replacing the Optional Staple Cartridge](#)

Ink Safety Precautions

- Keep ink cartridges and maintenance box out of the reach of children and do not drink the ink.
- Keep the ink cartridges out of direct sunlight.
- Store ink cartridges in a cool, dark place; do not store the ink cartridges in high or freezing temperatures.
- Be careful when you handle used ink cartridges; there may be ink remaining around the ink supply port. If ink gets on your skin, wash it off with soap and water. If it gets in your eyes, flush them immediately with water. If you experience discomfort or vision problems after flushing your eyes, see a doctor immediately. If ink gets in your mouth, see a doctor immediately.
- Do not dismantle an ink cartridge. This could damage the print head.
- Do not disassemble or modify the ink cartridge or maintenance box; otherwise ink or maintenance fluid may get into your eyes or on your skin or you may not be able to print normally.
- Do not shake cartridges too vigorously; this can cause them to leak.
- Do not drop or knock ink cartridges against hard objects; this can cause leakage.
- Do not remove or tear the label on the cartridge; this can cause leakage.

- Use an ink cartridge before the date printed on its package or within one year of opening the package, whichever is earlier.
- After bringing an ink cartridge inside from a cold storage site, allow it to warm up at room temperature for at least three hours before using it.
- Do not open the ink cartridge package until you are ready to install it in the printer. The cartridge is vacuum packed to maintain its reliability. Leaving a cartridge unpacked for a long time before using it may prevent normal operation.
- Do not break the hooks on the side of the cartridge when removing it from the packaging.
- Do not shake cartridges after opening their packages; this can cause them to leak.
- Do not remove the transparent seal from the bottom of the cartridge. This may cause the cartridge to become unusable.
- Do not touch the green IC chip on the side of the cartridge. This may prevent normal operation.
- Make sure to install all ink cartridges. The printer only works when all ink cartridges are properly installed.
- Do not turn off the product during ink charging. If ink charging is incomplete, you may not be able to print.
- If you remove an ink cartridge for later use, protect the ink supply area from dirt and dust and store it in the same environment as the product. Note that there is a valve in the ink supply port, making covers or plugs unnecessary, but care is needed to prevent the ink from staining items that the cartridge touches. Do not touch the ink cartridge ink supply port or surrounding area.
- Install a new ink cartridge immediately after removing an expended one. Leaving cartridges uninstalled can dry out the print head and may prevent the product from printing.
- Do not turn off the printer during cartridge replacement. Otherwise, ink remaining in the print head nozzles will dry out and you may not be able to print.
- Do not put your hands inside the product or touch any cartridges during printing.
- Removed ink cartridges may have ink around the ink supply port, so be careful not to get any ink on the surrounding area when removing the cartridges.
- The specifications and appearance of the ink cartridge may be modified for improvement without prior notice.

Ink Consumption

- This printer uses ink cartridges equipped with a green chip that monitors information such as the amount of remaining ink for each cartridge. This means that even if the cartridge is removed from the

printer before it is expended, you can still use the cartridge after reinserting it back into the printer. However, when reinserting a cartridge, some ink may be consumed to guarantee printer performance.

- To ensure you receive premium print quality and to help protect your print head, a variable ink safety reserve remains in the cartridge when your printer indicates that it is time to replace the cartridge. Quoted ink yields do not include this reserve.
- Quoted yields may vary depending on the images that you are printing, the paper type that you are using, the frequency of your prints and environmental conditions such as temperature.
- Do not use the cartridges that came with the printer for the replacement. The ink in the ink cartridges supplied with your printer is partly used during initial setup. In order to produce high quality printouts, the print head in your printer needs to be fully charged with ink. This process consumes a quantity of ink and, therefore, these cartridges may print fewer pages compared to subsequent ink cartridges.
- To maintain optimum print head performance, some ink is consumed from all ink cartridges during maintenance operations. Ink may also be consumed when you replace an ink cartridge or turn the printer on.
- When printing in monochrome or grayscale, color inks may be used instead of black ink depending on the paper type or print quality settings you are using.

Parent topic: [Replacing Ink Cartridges, Maintenance Boxes, and Cassette Rollers](#)

Related references

[Ink Cartridge Specifications](#)

Check Cartridge and Maintenance Box Status

Your product and its software will let you know when an ink cartridge is low or expended, or when the maintenance box needs to be replaced.

Note: When using the Epson Universal Print Driver or PostScript (PS3) printer software with the product, you can check ink cartridge and maintenance box status by using the printer buttons or the utilities included with the standard Epson printer software. To download the standard Epson printer software, visit epson.com/support (U.S.), epson.ca/support (Canada), or latin.epson.com/support (Latin America) and select your product.

[Checking Ink Status on the LCD Screen](#)

[Checking Ink and Maintenance Box Status with Windows](#)

[Checking Cartridge and Maintenance Box Status - Mac](#)

Parent topic: [Replacing Ink Cartridges, Maintenance Boxes, and Cassette Rollers](#)

Checking Ink Status on the LCD Screen

When one of your ink cartridges is low or expended, you see a message on the LCD screen. Select **How-to** and follow the steps on the LCD screen to replace the ink cartridge.

You can also check the status of the ink cartridges and maintenance box from the product control panel.

Note: You can continue printing while the low ink message is displayed. Replace the ink cartridges when required.

1. Press the  home button, if necessary.

2. Select the  icon.

3. Select the **Consumables/Others** tab.



Parent topic: [Check Cartridge and Maintenance Box Status](#)

Checking Ink and Maintenance Box Status with Windows

You can check your ink cartridge or maintenance box status at any time using a utility on your Windows computer.

Note: You can continue printing while the low ink message is displayed. Replace the ink cartridges when required.

1. To check your status, do one of the following:

- **Windows 11:** Click , search for **Settings** and select it. Select **Bluetooth & devices > Printers & scanners**. Select your product name and select **Printer preferences**.
- **Windows 10:** Click  and select  (Settings) > **Devices > Printers & scanners**. Select your product name and select **Manage > Printer preferences**.
- **Windows 8.x:** Navigate to the **Apps** screen and select **Control Panel > Hardware and Sound > Devices and Printers**. Right-click your product and select **Printer preferences**.

2. Select the **Maintenance** tab and select **EPSON Status Monitor 3**.

3. Replace or reinstall the ink cartridge or maintenance box as indicated on the screen. Select **Details** if necessary.

Note: If any of the ink cartridges installed in the product is broken, incompatible with the product model, or improperly installed, Epson Status Monitor will not display an accurate ink status.

Parent topic: [Check Cartridge and Maintenance Box Status](#)

Checking Cartridge and Maintenance Box Status - Mac

You can check the status of your ink cartridges and maintenance box using a utility on your Mac.

Note: You can continue printing while the low ink message is displayed. Replace the ink cartridges when required.

1. In the Apple menu or the Dock, select **System Preferences** or **System Settings**. Select **Print & Fax**, **Print & Scan**, or **Printers & Scanners**, select your product, and select **Options & Supplies**. Select **Utility** and select **Open Printer Utility**.
2. Select **EPSON Status Monitor**.
3. Do the following as necessary:
 - You can update the ink cartridge and maintenance box status by clicking **Update**.
 - Replace or reinstall the maintenance box or any ink cartridge as indicated on the screen.

Note: If any of the cartridges installed in the product is broken, incompatible with the product model, or improperly installed, Epson Status Monitor will not display an accurate cartridge status.

Parent topic: [Check Cartridge and Maintenance Box Status](#)

Replacing Ink Cartridges and Maintenance Boxes

The maintenance box stores ink that gets flushed from the system during print head cleaning. When an ink cartridge is expended or the maintenance box is at the end of its service life, you need to replace it.

You may also need to replace a cartridge that is more than six months old if your printouts do not look their best, even after cleaning and aligning the print head.

Note: Please dispose of your used Epson branded ink cartridges and maintenance boxes responsibly and in accordance with local requirements. If you would like to return your used ink cartridges and maintenance boxes to Epson for proper disposal, please go to [epson.com/recycle](https://www.epson.com/recycle) for more information.

[Purchase Epson Ink Cartridges and Maintenance Box](#)
[Ink Cartridge and Maintenance Box Part Numbers](#)
[Removing and Installing Ink Cartridges](#)
[Replacing the Maintenance Box](#)

Parent topic: [Replacing Ink Cartridges, Maintenance Boxes, and Cassette Rollers](#)

Purchase Epson Ink Cartridges and Maintenance Box

U.S. and Canada:

You can purchase genuine Epson ink, maintenance boxes, and paper at [epson.com](#) (U.S. sales) or [epson.ca](#) (Canadian sales). You can also purchase supplies from an Epson authorized reseller. To find the nearest one, call 800-GO-EPSON (800-463-7766) in the U.S. or 800-807-7766 in Canada.

Latin America:

You can purchase genuine Epson ink, maintenance boxes, and paper from an Epson authorized reseller. To find the nearest reseller, visit [latin.epson.com](#) or call your nearest Epson sales office.

Note: This product is designed to work with genuine Epson inks. Non-Epson ink or any other ink not specified for this printer could cause damage not covered by Epson's warranties.

Parent topic: [Replacing Ink Cartridges and Maintenance Boxes](#)

Ink Cartridge and Maintenance Box Part Numbers

Use these part numbers when you order or purchase new ink cartridges or maintenance boxes.

Maintenance box part number: C12C937181

AM-C6000/AM-C5000

Ink color	Part number
Black	T08C1
Cyan	T08C2
Magenta	T08C3
Yellow	T08C4

AM-C4000

Ink color	Part number
Black	T08D1
Cyan	T08D2
Magenta	T08D3
Yellow	T08D4

Parent topic: [Replacing Ink Cartridges and Maintenance Boxes](#)

Removing and Installing Ink Cartridges

If an ink cartridge is low or expended, a message appears on your product's LCD screen. Note which ink cartridge needs to be replaced. Select **How To** and follow the steps on the LCD screen to remove and install the ink cartridges.

Make sure you have the replacement ink cartridge(s) handy before you begin. You must install new cartridges immediately after removing the old ones.

Caution: Leave your old cartridges in the printer until you are ready to replace them to prevent the print head nozzles from drying out. Do not open ink cartridge packages until you are ready to install the ink. Cartridges are vacuum packed to maintain reliability.

Caution: If you remove an ink cartridge for later use, protect the ink supply area from dirt and dust and store it in the same environment as the printer. The valve in the ink supply port is designed to contain any excess ink, but do not touch the ink supply port or surrounding area. Always store ink cartridges with the label facing up; do not store cartridges upside-down.

Parent topic: [Replacing Ink Cartridges and Maintenance Boxes](#)

Replacing the Maintenance Box

If the maintenance box is full, a message appears on your product's LCD screen. Select **How To** and follow the steps on the LCD screen to replace the maintenance box.

Make sure you have the replacement maintenance box handy before you begin.

Caution: Do not reuse a maintenance box that has been removed and left uninstalled for more than a week. Keep the maintenance box away from direct sunlight.

Parent topic: [Replacing Ink Cartridges and Maintenance Boxes](#)

Replacing the Paper Feed Rollers

When the paper feed rollers in the paper cassettes need to be replaced, you see a message on the LCD screen. (These are also referred to as "pickup rollers".)

There are different paper feed rollers for the paper cassettes, the paper tray, and the ADF unit. Make sure you install the correct paper feed rollers for the product.

- For Paper Cassettes 1-4, use the "Paper Feed Roller for Cassette" (C12C937321)
- For the Paper Tray, use the "Paper Feed Roller for Paper Tray" (C12C937361)
- For the ADF, use the "Paper Feed Roller for ADF" (C12C937341)

Refer to the instructions in the paper feed roller packaging when replacing the paper feed rollers. There are also replacement videos available on your product's support page.

Reset the maintenance roller counter for the paper cassette to keep track of roller usage.

Parent topic: [Replacing Ink Cartridges, Maintenance Boxes, and Cassette Rollers](#)

Replacing the Optional Staple Cartridge

Follow the steps below to replace the optional staple cartridge in the optional finisher unit.

You can purchase genuine Epson accessories at epson.com (U.S. sales) or epson.ca (Canadian sales). You can also purchase accessories from an Epson authorized reseller. To find the nearest one, call 800-GO-EPSON (800-463-7766) in the U.S. or 800-807-7766 in Canada.

1. When it is time to replace the staple cartridge, you see a message on the LCD screen.
2. Follow the on-screen instructions to replace the cartridge.

Note: Only replace the cartridge when all of the staples have run out. You cannot replace the cartridge if staples remain in the cartridge.

Do not discard the staple cartridge holder* shown in the illustration when replacing the staple cartridge. Reuse the holder with the new staple cartridge.

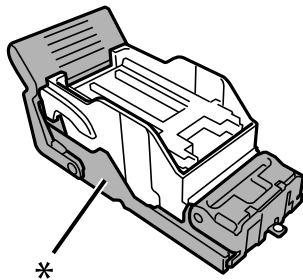

Parent topic: [Replacing Ink Cartridges, Maintenance Boxes, and Cassette Rollers](#)

Adjusting Print Quality

If your print quality declines, you may need to use the product buttons to run a nozzle check and clean the print head.

Note: If you are using your Epson product with the Windows 10 S operating system, you cannot use the software described in this section. You also cannot download and install any Epson product software from the Epson website for use with Windows 10 S; you must obtain software only from the Windows Store.

If running these utilities does not solve the problem, you may need to replace the ink cartridges.

[Print Head Maintenance](#)

[Automatically Cleaning the Print Head Using the Product Control Panel](#)

Print Head Maintenance

If your printouts become too light, or you see dark or light bands across them, you may need to clean the print head nozzles. Cleaning uses ink, so clean the nozzles only if print quality declines.

You can check for clogged nozzles before you clean them so you don't clean them unnecessarily.

Note: You cannot clean the print head if an ink cartridge is expended, and may not be able to clean it when a cartridge is low. You must replace the cartridge first.

[Checking the Nozzles Using the Product Control Panel](#)

[Cleaning the Print Head Using the Product Control Panel](#)

Parent topic: [Adjusting Print Quality](#)

Checking the Nozzles Using the Product Control Panel

You can check the print head nozzles using the control panel on your product.

1. Make sure there are no errors on the LCD screen.
2. Load a few sheets of plain paper in the product.
3. Press the  home button, if necessary.
4. Select **Settings** > **Maintenance** > **Print Head Nozzle Check**.

5. Select a paper cassette with Letter (8.5 × 11 inches [216 × 279 mm]) or A4 (8.3 × 11.7 inches [210 × 297 mm]) paper and select **OK**.

The nozzle pattern prints.

6. Check the printed pattern to see if there are gaps in the lines.

Print head is clean



Print head needs cleaning



7. Do one of the following:
 - If there are no gaps, select **OK**.
 - If there are gaps or the pattern is faint, select **NG** and continue.
8. Follow the instructions on the screen to clean the print head, check the nozzles, and repeat the process as necessary.

Caution: Never turn off the product or open the front cover during a cleaning cycle or you may not be able to print.

Parent topic: [Print Head Maintenance](#)

Cleaning the Print Head Using the Product Control Panel

You can clean the print head using the control panel on your product.

1. Make sure there are no errors on the LCD screen.
2. Load a few sheets of plain paper in the product.
3. Press the  home button, if necessary.
4. Select **Settings** > **Maintenance** > **Print Head Cleaning**.
5. Select **Start** to clean the print head.

When the cleaning cycle is finished, you see a message on the LCD screen.

Caution: Never turn off the product or open the front cover during a cleaning cycle or you may not be able to print.

6. Select **Yes** to print a nozzle check pattern and follow the on-screen instructions.

Parent topic: [Print Head Maintenance](#)

Automatically Cleaning the Print Head Using the Product Control Panel

You can set the product to automatically check and clean the print head before printing using the control panel on your product. The product will automatically detect clogged nozzles and run the head cleaning procedure until the nozzles are clear.

Note: Because Auto Cleaning may repeat head cleaning multiple times, it may take longer and use more ink than performing a Print Head Cleaning.

1. Press the  home button, if necessary.
2. Select **Auto Cleaning**.
3. Select **Start** to clean the print head.

When the cleaning cycle is finished, you see a message on the LCD screen.

Caution: Never turn off the product or open the front cover during a cleaning cycle or you may not be able to print.

4. Select **Yes** to print a nozzle check pattern and follow the on-screen instructions.

Parent topic: [Adjusting Print Quality](#)

Cleaning and Transporting Your Product

See these sections if you need to clean or transport your product.

[Cleaning Your Product](#)

[Cleaning the Scanner Glass](#)

[Cleaning the Automatic Document Feeder](#)

[Moving or Transporting Your Product](#)

Cleaning Your Product

To keep your product working at its best, you should clean it several times a year.

Caution: Do not use a hard brush, alcohol, or paint thinner to clean the product or you may damage it. Do not use oil or other lubricants inside the product or let water get inside it.

1. Turn off the product.
2. Unplug the power cord.
3. Disconnect any connected cables.
4. Clean the outer case and control panel with a soft, dry cloth. Do not use liquid or chemical cleansers.

Parent topic: [Cleaning and Transporting Your Product](#)

Cleaning the Scanner Glass

You can clean the scanner glass if your copies or scanned images are smeared.

Caution: Do not use a hard brush, alcohol, or paint thinner to clean the product or you may damage it. Do not use oil or other lubricants inside the product or let water get inside it.

1. Open the document cover.

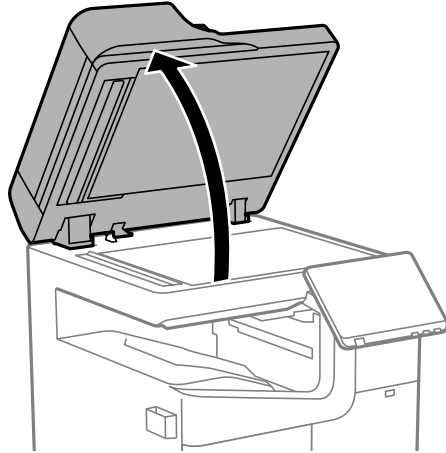

2. Remove the cleaning cloth from its holder.

Note: The cleaning cloth holder may be located in a different location than the one shown.

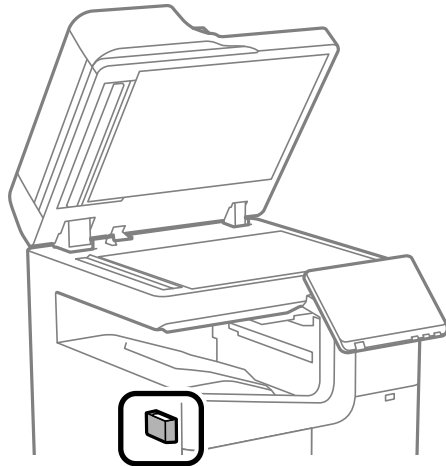

3. Use the cleaning cloth to wipe the scanner glass.

Note: If the glass is stained with grease or dirt, use a small amount of glass cleaner on a soft, dry cloth to remove it. Wipe off all remaining liquid after removing the dirt.

Caution: Do not spray glass cleaner directly on the glass and do not press the glass surface with any force.

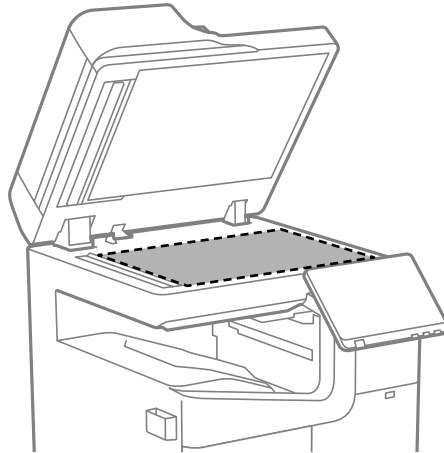

4. Return the cleaning cloth to its holder when you are finished.
5. Close the document cover.

Parent topic: [Cleaning and Transporting Your Product](#)

Cleaning the Automatic Document Feeder

You can clean the ADF if you see lines or streaks in your copies or scanned images.

Caution: Do not use a hard brush, alcohol, or paint thinner to clean the product or you may damage it. Do not use oil or other lubricants inside the product or let water get inside it.

1. Lift the lever and open the ADF cover.

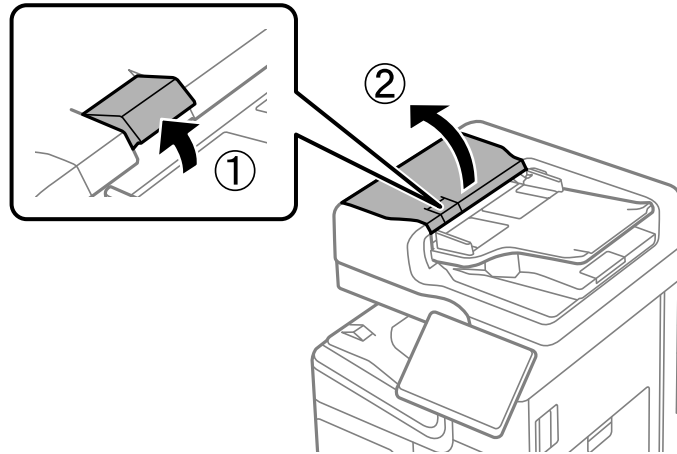

2. Use a soft, lint-free cloth (microfiber is recommended) moistened with a little water to clean the rollers and the interior of the ADF.

Caution: Do not use a dry cloth; you may damage the ADF rollers.

Note: Wait until the rollers are dry before using the ADF.

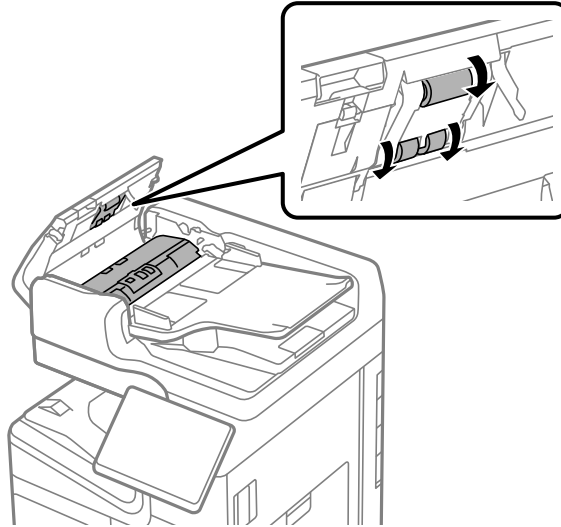

3. Close the ADF cover. The lever clicks when the cover is fully closed.

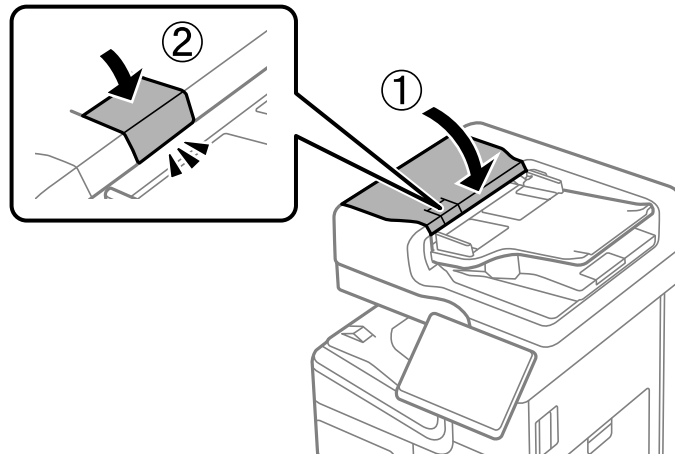

4. Open the document cover.

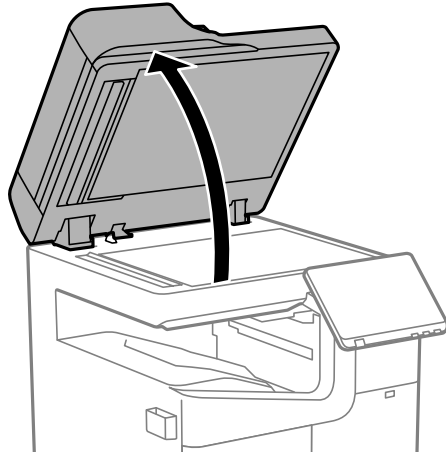

5. Remove the cleaning cloth from its holder.

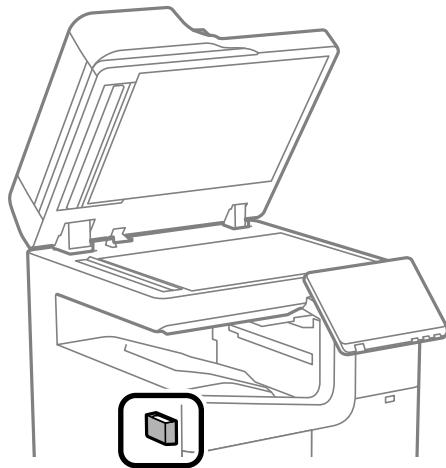

6. Clean the areas shown in the illustration. You will need to lift the edge of the document cover to reach some locations.

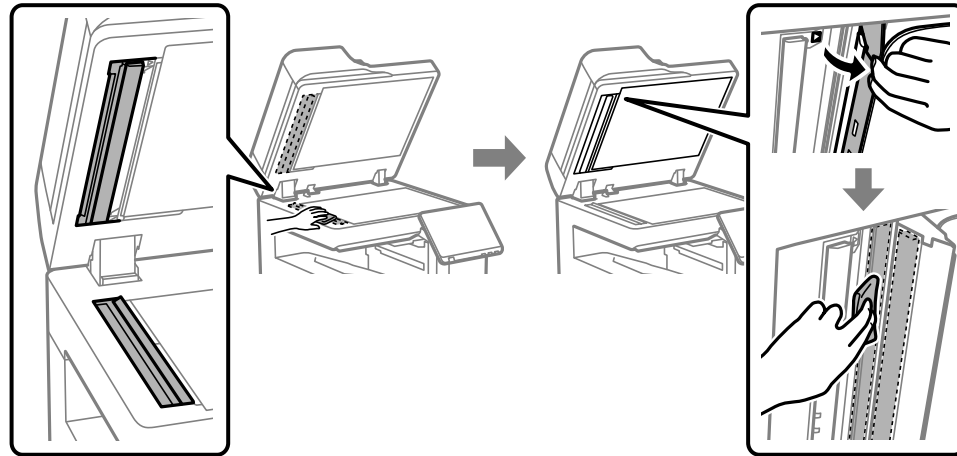

7. Return the cleaning cloth to its holder when you are finished.
8. Close the document cover.

Parent topic: [Cleaning and Transporting Your Product](#)

Moving or Transporting Your Product

If you need to move or transport your product, contact Epson support or an authorized Epson service provider or technician.

Caution: At least four people are required to move the product.

Parent topic: [Cleaning and Transporting Your Product](#)

Solving Problems

Check these sections for solutions to problems you may have using your product.

[Viewing the Help Screen](#)

[Product Status Messages](#)

[Job Status Error Codes](#)

[Running a Product Check](#)

[Resetting Control Panel Defaults](#)

[Solving Setup Problems](#)

[Solving Network Problems](#)

[Solving Network Security Problems](#)

[Solving Copying Problems](#)

[Solving Copy Quality Problems](#)

[Solving Paper Problems](#)

[Solving Problems Printing from a Computer](#)

[Solving Page Layout and Content Problems](#)

[Solving Print Quality Problems](#)

[Solving Scanning Problems](#)

[Solving Scanned Image Quality Problems](#)

[Solving Faxing Problems](#)

[Solving USB Device Problems](#)

[Uninstall Your Product Software](#)

[Where to Get Help \(U.S. and Canada\)](#)

[Where to Get Help \(Latin America\)](#)

Viewing the Help Screen

You can view troubleshooting or how-to topics on the LCD screen at any time.

1. Select the  help icon.
2. Select a **Troubleshooting** or **How To** option to view instructional images or animations.

Parent topic: [Solving Problems](#)

Product Status Messages

You can often diagnose problems with your product by checking the messages and status icons on its LCD screen. You can also check for errors by selecting **Job/Status > Printer Status**.

Note: If the LCD screen is dark, press the screen to wake the product from sleep mode.

LCD screen message	Condition/solution
Printer error. Turn the power off and on again. For details, see your documentation.	Turn the product off and then back on again. If the error persists, check for and remove any jammed paper or protective materials from the product, and disconnect any optional installed units. If the error persists, contact Epson for support.
Printer error. For details, see your documentation.	The product may be damaged, but features such as scanning are still available. Contact Epson for support.
Cannot print because XX is out of order. You can print from another cassette.	Turn the product off and then back on again. Reinsert the indicated paper cassette. If the error persists, contact Epson for support.
HDD error. Turn the printer off and back on again. If the error continues, contact Epson support.	The hard disk drive is damaged. You may not be able to receive faxes (models equipped with optional fax board) or copy or print documents that contain images. Copying more than 50 pages of Text & Image A4/Letter documents may fail. Contact Epson for support.
XX are nearing the end of their service life.	A consumable part in your product needs to be replaced. Contact Epson for support.
XX are nearing the end of their service life.	Contact Epson for support.
XX is at the end of its service life. Replace it.	
You need to replace the following ink cartridge(s). Confirm the procedure, and then replace them.	Replace the indicated ink cartridge(s).
Paper Setup Auto Display is set to Off. Some features may not be available. For details, see your documentation.	The Paper Setup Auto Display setting must be turned on to use AirPrint.

LCD screen message	Condition/solution
No dial tone detected. (models with optional fax board installed)	Make sure the phone cable is connected correctly and the phone line works. If you connected the product to a PBX (Private Branch Exchange) phone line or Terminal Adapter, change the Line Type setting to PBX . Use # instead of the actual access code when entering an outside fax number. If you still cannot send a fax, turn off the Dial Tone Detection setting. (Turning off the Dial Tone Detection setting may cause the product to drop the first digit of a fax number.)
Failed to receive faxes because the fax data capacity is full. Touch the Job/Status at the bottom of the Home Screen for details. (Models equipped with optional fax board)	Select Job/Status > Printer Status and resolve any errors that are preventing faxes from printing. Make sure the product is connected to a computer and it is turned on, or connect a memory device to the product.
The combination of the IP address and the subnet mask is invalid. See your documentation for more details.	There is a problem with the network connection to your product. Set up your product on the network again.
To use cloud services, update the root certificate from the Epson Web Config utility.	Access the Web Config utility and update the cloud service root certificate.
Check that the printer driver is installed on the computer and that the port settings for the printer are correct.	Make sure the printer port is correctly configured. In Windows, make sure the port is set to a USBXXX setting for a USB connection or EpsonNet Print Port for a network connection.
Check that the printer driver is installed on the computer and that the USB port settings for the printer are correct.	
The file name is already in use. Rename the file and scan again.	Change the file name settings, move or delete the files, or change the file name on the shared folder.
Scanned file(s) are too large. Only XX page(s) have been sent. Check if the destination has enough space.	There is not enough disk space on the computer. Increase the free space on the computer.

LCD screen message	Condition/solution
DNS error. Check DNS settings.	Unable to connect to the computer. Make sure the address in the contacts list on the product and of the shared folder match. If the IP address of the computer is static and is set manually, change the computer name in the network path to the IP address. For example, change \\EPSON02\SCAN to \\192.168.XX.XX\SCAN. Make sure the computer is turned on and is not going to enter sleep mode. Temporarily disable the computer's firewall and security software. If this clears the error, check the security software settings. If Public network is selected as the network place, you cannot save the scanned images to the shared folder. Set the forward settings for each port. If you are using a laptop computer and the IP address is set as DHCP, the IP address may change when reconnecting to the network. Obtain the IP address again. Make sure the DNS setting is correct. The computer name and IP address may differ when the management table of the DNS server is not updated. Contact your network administrator and your DNS server administrator.
Authentication error. Please check the Email Server Settings.	Make sure the user name and password on the computer, and the contacts on the printer, are correct. Also, make sure that the password has not expired.
Communication error. Check the Wi-Fi/network connection.	Unable to communicate with a network folder that is registered on the contacts list. Make sure Use Microsoft network sharing (Network > MS Network) is enabled in the Web Config. Make sure the address in the contacts list on the product and of the shared folder match. Access rights for the user in the contacts list should be added on the Sharing and Security tabs of the shared folder's properties. Set the user's permissions to allowed .
Recovery mode Update Firmware	An error has occurred during firmware updating. Connect your product using a USB cable and try downloading the Firmware Update from the Epson support site. If you need help, contact Epson for support.

Parent topic: [Solving Problems](#)

Job Status Error Codes

If a printing, scanning, copying, or faxing (models equipped with optional fax board) job does not complete successfully, you can check the error code for the reason. Select **Job/Status > Job Status** to view the error codes.

Code	Condition/solution
001	The product was turned off by a power failure.
101	Memory is full. Reduce the size of the print job.
102	Collated printing has failed due to a lack of available memory. Reduce the size of the print job or print one copy at a time.
103	Print quality was decreased due to a lack of available memory. If the quality of the printout is unacceptable, try simplifying the page by reducing the number of graphics or the number and size of the fonts.
104 131	Reverse order printing has failed due to a lack of available memory. Reduce the size of the print job.
106	Cannot print from the computer due to access control settings. Contact your product administrator.
107	User authentication failed and the job has been canceled. Contact your product administrator.
108	Confidential job data was deleted when the product was turned off.
109	The received fax was already deleted (models equipped with optional fax board).
110	The job was printed 1-sided because the loaded paper does not support 2-sided printing.
111	Available memory is running low. Reduce the size of the print job.
120	Cannot communicate with a server using an open platform. Check the server or network for errors.
130	Collated printing has failed due to a lack of available memory. Reduce the size of the print job or change the collate settings.
132	Cannot print due to a lack of available memory. Reduce the size of the print job.
133	Cannot print 2-sided due to a lack of available memory. Only one side will print. Reduce the size of the print job.
141	HDD error. The job is canceled. Contact Epson for support.

Code	Condition/solution
151	Cannot print because the user name associated with the confidential job does not match.
161	Page count management is set in Epson Print Admin Serverless. Could not print because the number of remaining pages is insufficient.
201	The product's memory is full. You can send pages individually, or print received faxes and delete them to free up memory space (models equipped with optional fax board).
202	The line was disconnected by the recipient's fax machine (models equipped with optional fax board). Wait a moment, then try again.
203	The product cannot detect a dial tone (models equipped with optional fax board). Make sure the phone cable is connected correctly and the phone line works. If you connected the product to a PBX (Private Branch Exchange) phone line or Terminal Adapter, change the Line Type setting to PBX . If you still cannot send a fax, turn off the Dial Tone Detection setting. (Turning off the Dial Tone Detection setting may cause the product to drop the first digit of a fax number.)
204	The recipient's fax machine is busy (models equipped with optional fax board). Wait a moment, then try again.
205	The recipient's fax machine does not answer (models equipped with optional fax board). Wait a moment, then try again.
206	The phone cable is incorrectly connected to the product's LINE and EXT ports (models equipped with optional fax board). Connect the phone cable correctly.
207	The phone cable is not connected (models equipped with optional fax board). Connect the phone cable.
208	The fax could not be sent to some of the specified recipients (models equipped with optional fax board). Print a fax log to check which recipients failed to receive the fax. If the Save Failure Data setting is turned on, you can resend a fax by selecting Job Status in the Job/Status menu.
301 401	There is not enough storage space available to save the data in the external memory device. Clear space on the device or use a different device.
302 402	The external memory device is write-protected. Disable write protection.
303	No folder is available for saving the scanned file. Create a folder or use a different memory device.

Code	Condition/solution
304 404	The external memory device has been removed. Reinsert the device.
305 405	An error occurred while saving data to an external memory device. Reinsert the memory device or use a different device.
306	The product's memory is full. Wait until current jobs are finished processing.
307	The scanned image size exceeds the maximum limit. Lower the scanning resolution or increase the compression ratio to reduce the size of the scanned image.
311 321 411 421	A DNS error has occurred. From the Home screen, select Settings > General Settings > Network Settings > Advanced > TCP/IP and check the DNS settings for the server, computer, or access point.
312 412	An authentication error has occurred. From the Home screen, select Settings > General Settings > Network Settings > Advanced > Email Server > Server Settings and check the server settings.
313 413	A communication error has occurred. From the Home screen, select Settings > General Settings > Network Settings > Advanced > Email Server > Server Settings and check the server settings. Print a network connection report to check if the product is connected to the network. The authentication method of the settings and the email server may not match. If the authentication method is set to Off , make sure the authentication method of the email server is set to None .
314	The data size exceeds the maximum size for the attached files. From the Home screen, select Scan > Email > Scan Settings and scroll down to select Attached File Max Size . Increase the setting or lower the file size of the scanned image.
315 327	The memory is full. Wait for current jobs to finish and try again.
316	A mail encryption error has occurred. Make sure the encryption certificate setting and product time setting are correct.
317	A mail signature error has occurred. Make sure the signing certificate setting and product time setting are correct.
318	A domain restriction error has occurred. Contact your administrator to check if the domain of your email destination is restricted.

Code	Condition/solution
322	An authentication error occurred while scanning. From the Home screen, select Scan > Network Folder/FTP > Keyboard > Location and check the settings.
323 331	A communication error has occurred while scanning. From the Home screen, select Scan > Network Folder/FTP > Keyboard > Location and check the settings. You can also print a network status sheet to check the network connection.
324	A file with the same name already exists in the specified folder for scanning. Delete the duplicate file or change the file name prefix. From the Home screen, select Scan > Network Folder/FTP > Scan Settings > File Name .
325 326	There is not enough storage space available in the specified folder. Increase the storage space in the specified folder, delete unnecessary files, or lower the file size of the scanned image.
328	The destination for scanning was wrong or the destination does not exist. From the Home screen, select Scan > Network Folder/FTP > Keyboard > Location and check the settings.
329	The scanned image size exceeds the maximum limit for the Network Folder/FTP scan option. Lower the scanning resolution or increase the compression ratio.
330	An FTPS/FTPS secure connection error has occurred. Check the location in the destination settings. Run Web Config and update the root certificate, and import or update the CA certificate. If the error cannot be cleared, disable certificate verification in the destination settings.
332	There is not enough space available for saving the scanned files in the specified folder. Delete unnecessary files from the specified folder.
333	The destination could not be found because the destination information was uploaded to the server before sending the scanned data. Select the destination again.
334	An error occurred while sending the scanned data.
341	A communication error has occurred while scanning. Make sure the product is connected to the computer or network correctly and that you installed Document Capture Pro or Document Capture. Make sure the Event Manager program is not being blocked by your firewall or security software.
342	All scanned originals were detected as blank pages. Make sure that the front and back sides of the original are correct. If some pages are skipped as black, lower the detection level of the Skip Blank Pages > Sensitivity setting.
343	The OCR device is damaged. Contact Epson Support.

Code	Condition/solution
350	An FTPS/HTTPS certificate error has occurred. If the error cannot be cleared, disable certificate verification in the destination settings.
422	An authentication error has occurred while faxing (models equipped with optional fax board). From the Home screen, select Settings > General Settings > Fax Settings > Receive Settings > Save/Forward Settings and check the settings for the folder selected in Destination .
423	A communication error has occurred while faxing (models equipped with optional fax board). From the Home screen, select Settings > General Settings > Fax Settings > Receive Settings > Save/Forward Settings . Select the arrow icon at the end of an entry and check the Save/Forward Destination setting. You can also print a network status sheet to check the network connection.
425	There is not enough storage space available in the forwarding destination folder for faxing (models equipped with optional fax board). Increase the storage space.
428	The destination for faxing was wrong or the destination does not exist (models equipped with optional fax board). From the Home screen, select Settings > General Settings > Fax Settings > Receive Settings > Save/Forward Settings . Select the arrow icon at the end of an entry and check the Save/Forward Destination setting.
501	Cannot use the storage feature. Check the user permissions from Web Config.
502	The storage area is full. Delete unnecessary saved jobs from the control panel or Web Config.
504	The number of files has reached the maximum limit. Delete unnecessary saved jobs from the control panel or Web Config.
505	A read/write error has occurred in the product's storage. Contact Epson for support.
506	When outputting files from the storage, the maximum number of pages for a job has been reached. The maximum size of a job from storage is 2000 pages.

Parent topic: [Solving Problems](#)

Running a Product Check

Running a product check helps you determine if your product is operating properly.

1. Disconnect any interface cables connected to your product.
2. Load plain paper in the product.

3. Press the  home button, if necessary.
4. Select **Settings > Maintenance > Print Head Nozzle Check**.
5. Select a paper cassette and select **OK**.
The nozzle pattern prints.
6. Do one of the following, depending on the results of the product check:
 - If the page prints and the nozzle check pattern is complete, the product is operating properly. Any operation problem you may have could be caused by your computer, cable, software, or selected settings. Check the other solutions in this book or try uninstalling and reinstalling your printer software.
 - If the page prints but the nozzle check pattern has gaps, clean the print head.
 - If the page does not print, the product may have a problem. Check the other solutions in this manual. If they do not work, contact Epson.

Parent topic: [Solving Problems](#)

Resetting Control Panel Defaults

If you have a problem with settings on the product control panel, you can reset them to their factory defaults. You can choose which settings to reset or reset them all.

Note: This setting can be locked by an administrator. If you cannot access or change this setting, contact your administrator for assistance.

Note: This product automatically stores names, telephone numbers, and fax data (models equipped with an optional fax board) in its internal memory log when faxing or emailing jobs. This product also contains an encrypted hard drive that is used for storing large and/or authenticated print, copy and scan jobs. You may erase data stored on the encrypted hard drive by following the steps outlined in the link below. It is recommended that data is erased before disposing or giving away the product.

1. Press the  home button, if necessary.
2. Select **Settings > General Settings > System Administration > Reset**.

Note: You may need to enter the administrator password.

You see a screen like this:

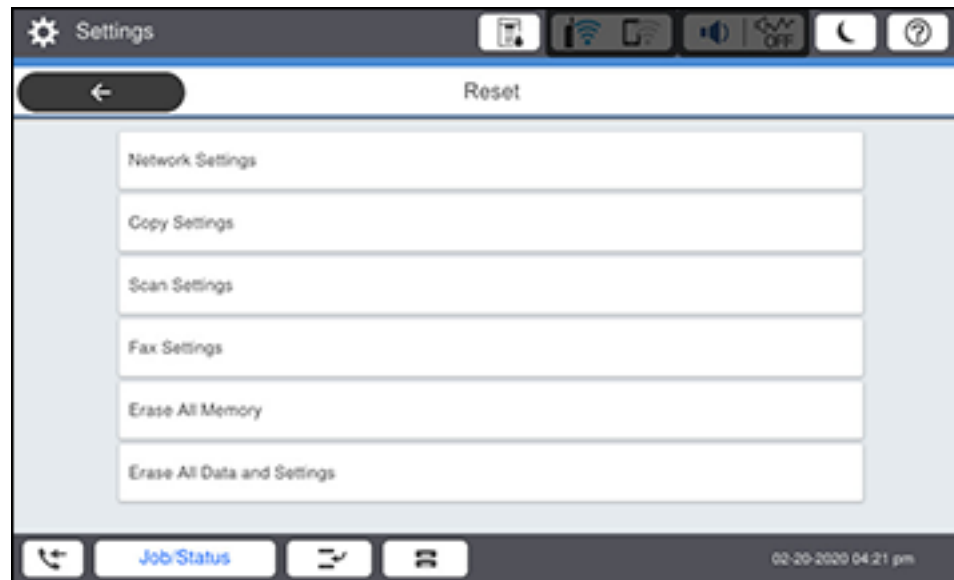

3. Select one of these options:

- **Network Settings:** Resets all network settings
- **Copy Settings:** Resets all settings for copying
- **Scan Settings:** Resets all settings for scanning
- **Fax Settings :** Resets all settings for faxing
- **Erase All Memory:** Resets all control panel settings including the contacts list. Select from **High Speed, Overwrite, or Triple Overwrite.**
- **Erase All Data and Settings:** Resets all control panel settings including the contacts list. Select from **High Speed, Overwrite, or Triple Overwrite.**

Note: **High Speed** erases the data on the hard drive. The **Overwrite** and **Triple Overwrite** options also overwrite any invalid data in the hard drive. **Overwrite** takes about 60 minutes to complete and **Triple Overwrite** takes about 280 minutes to complete.

You see a confirmation screen.

4. Select **Yes** to reset the selected settings. (Select **No** if you want to cancel the operation.)

Parent topic: [Solving Problems](#)

Solving Setup Problems

Check these sections if you have problems while setting up your product.

[Product Does Not Turn On or Off](#)

[Noise After Ink Installation](#)

[Software Installation Problems](#)

Parent topic: [Solving Problems](#)

Product Does Not Turn On or Off

If you cannot turn the product on or off, try these solutions:

- If you cannot turn on your product, make sure the power cord is securely connected and hold down the power button a little longer.
- If you cannot turn off your product, hold down the power button a little longer. If you still cannot turn off your product, unplug the power cord, plug the power cord back in, then turn your product on and off again using the power button.

Parent topic: [Solving Setup Problems](#)

Noise After Ink Installation

If you hear noises from your product after installing ink, check the following:

- The first time you install the ink cartridges, the product must charge its print head. Wait until charging finishes before you turn off the product, or it may charge improperly and use excess ink the next time you turn it on.
- If the product's print head stops moving or making noise, and the charging process has not finished after approximately 5 minutes, turn off your product. Turn it back on and check to see if charging is still in progress. If it is still in progress, contact Epson for help.

Parent topic: [Solving Setup Problems](#)

Software Installation Problems

If you have problems while installing your product software, try these solutions:

- Make sure your product is turned on and any necessary cables are securely connected at both ends. Also make sure your system meets the requirements for your operating system. If you still have problems installing software, contact your system administrator.
- Close any other programs, including screen savers and virus protection software, and install your product software again.
- In Windows, make sure your product is selected as the default printer and the correct port is shown in the printer properties.
- If you see any error message or your software does not install correctly in Windows, you may not have software installation privileges. Contact your system administrator.

Parent topic: [Solving Setup Problems](#)

Solving Network Problems

Check these solutions if you have problems setting up or using your product on a network.

Note: Breakdown or repair of this product may cause loss of fax and network data and settings. Epson is not responsible for backing up or recovering data and settings during or after the warranty period. We recommend that you make your own backup or print out your fax and network data and settings.

[Product Cannot Connect to a Wireless Router or Access Point](#)

[Network Software Cannot Find Product on a Network](#)

[Wireless Network Connection is Unstable on a Mac](#)

[USB Connection Problems](#)

[Wired Network Connection Becomes Unstable](#)

[Product Does Not Appear in Mac Printer Window](#)

[Cannot Print Over a Network](#)

[Cannot Scan Over a Network](#)

Parent topic: [Solving Problems](#)

Product Cannot Connect to a Wireless Router or Access Point

If your product has trouble finding or connecting to a wireless router or access point, try these solutions:

- Verify that your router or access point is operating correctly by connecting to it from your computer or another device.
- Print a network connection report and check the codes and messages on the report to help determine the cause of the problem.
- You may need to disable the firewall and any anti-virus software on your wireless router or access point.
- Try restarting your router following the instructions in your router documentation.

Note: If you are reading these instructions online, you will lose your Internet connection when you restart your router.

- Check to see if access restrictions, such as MAC address filtering, are set on the router or access point. If access restrictions are set, add your product's MAC address to your router's address list. To obtain your product's MAC address, print a network status sheet. Then follow the instructions in your router or access point documentation to add the address to the list.
- If your router or access point does not broadcast its network name (SSID), follow the instructions that came with your product to enter your wireless network name manually.
- If your router or access point has security enabled, determine the kind of security it is using and any required password or passphrase for connection. Then make sure to enter the exact WEP key or WPA passphrase correctly.
- Check if your computer is restricting the available wireless channels. If so, verify that your wireless access point is using one of the usable channels and change to a usable channel, if necessary.
- If you cannot connect your product to a device using Wi-Fi Direct, you may have exceeded the maximum number of devices connected to your product (8). Print a network status sheet or access Web Config on the browser for your device and check the number of connected devices. If 8 devices are already connected, disconnect a device by deleting the product's SSID from the Wi-Fi screen of that device. If fewer than 8 devices are connected, check the accuracy of your other network settings, move your device closer to your product, and try connecting again.

Parent topic: [Solving Network Problems](#)

Related tasks

[Printing a Network Connection Report](#)

[Printing a Network Status Sheet](#)

Network Software Cannot Find Product on a Network

If EpsonNet Setup cannot find your product on a network, try these solutions:

- Make sure you have installed and set up the optional Wireless LAN Interface.
- Make sure your product is turned on and connected to your network. Verify the connection using your product control panel.
- Check if your network name (SSID) contains non-ASCII characters. Your product cannot display non-ASCII characters.
- Make sure your product is not connected to a guest network.
- If necessary, reinstall your product software and try running EpsonNet Setup again:
 1. Reset your product's network settings to their factory defaults.
 2. **Windows only:** Uninstall your product software.
 3. Restart your router following the instructions in your router documentation.

Note: If you are reading these instructions online, you will lose your Internet connection when you restart your router, so note the next step before restarting it.

4. Download your product software from the Epson website, or contact your system administrator.
- If you have replaced your router, reinstall your product software to connect to the new router.
 - Check to see if your wireless router or access point has an enabled Privacy Separator function that is preventing detection of your device over the network. See your router or access point documentation for instructions on disabling the Privacy Separator function.

Parent topic: [Solving Network Problems](#)

Related references

[Status Icon Information](#)

Related tasks

[Printing a Network Connection Report](#)

[Uninstalling Product Software - Windows](#)

Wireless Network Connection is Unstable on a Mac

If you connected a device to a USB 3.0 port on your Mac, you may experience wireless network interference between your product and your Mac.

If you cannot connect to your product over the wireless network or the connection becomes unstable, move the device connected to your Mac USB 3.0 port further away from your Mac.

If your wireless router or access point has a 5 GHz band, connect to it (U.S. and Canada only).

Note for U.S. and Canada: If your router uses a single network name (SSID) for both the 2.4 GHz and 5 GHz band, give each band its own network name (SSID) instead, such as Home Network 2.4 GHz and Home Network 5 GHz. See your router documentation or contact your internet service provider for instructions.

Parent topic: [Solving Network Problems](#)

USB Connection Problems

If you used a USB cable to connect to a computer that has multiple peripherals, make sure the computer is grounded. Otherwise, you may feel a slight electric shock when touching your product.

If the printer is not recognized while using a USB cable, make sure the cable is connected securely at both ends, and that you are not using a USB hub. You may also need to try a different USB cable.

[USB 3.0 Connection is Unstable When Using a USB 2.0 Cable](#)

Parent topic: [Solving Network Problems](#)

USB 3.0 Connection is Unstable When Using a USB 2.0 Cable

If you receive a communication error or experience an unstable connection when using a SuperSpeed USB port on your computer with a USB 2.0 cable, try these solutions:

- Use a USB 3.0 cable.
- Connect to a Hi-Speed USB port on your computer, if available.
- Connect to another SuperSpeed USB port on your computer, if available.

Parent topic: [USB Connection Problems](#)

Wired Network Connection Becomes Unstable

When you connect the product to a wired network using a router or access point that supports IEEE 802.3az (Energy Efficient Ethernet), the connection may become unstable, you may be unable to connect to the product, and the communication speed may become slow. If you experience any of these issues, follow the steps below to disable IEEE 802.3az and then connect your product again.

1. Disconnect the Ethernet cables connected to the computer and your product.
2. Disable IEEE 802.3az for the computer's network adapter if it is enabled (check your operating system's Ethernet connection settings).

3. Connect the computer and your product directly with an Ethernet cable.
4. Print a network connection report from your product.
5. On the computer, open a web browser and enter your product's IP address from the network connection report.
6. Select **Network Settings > Wired LAN**.
7. Select **OFF** for IEEE 802.3az. and click **Next**.
8. Click **OK** and remove the Ethernet cable connecting the computer and your product.
9. If you disabled IEEE 802.3az for your computer's network adapter, enable it.
10. Reconnect the Ethernet cables from the router or access point to your computer and product.
If problems still occur, other devices on the network may be causing them.

Parent topic: [Solving Network Problems](#)

Product Does Not Appear in Mac Printer Window

If your product does not appear in the Mac printer window, try these solutions:

- Turn your product off, wait 30 seconds, then turn it back on again.
- If you are connecting the product via Wi-Fi Protected Setup (WPS) and the Wi-Fi icon on your product's LCD screen is not lit, make sure you select one of the WPS options from the product control panel within 2 minutes of pressing the WPS button on your router.
- If you are connecting the product wirelessly via EpsonNet Setup and you do not see the Wi-Fi antenna icon with connection bars on your LCD screen, make sure your product software was installed correctly. If necessary, reinstall your software.

Parent topic: [Solving Network Problems](#)

Related tasks

[Uninstalling Product Software - Mac](#)

[Using WPS to Connect to a Network](#)

Cannot Print Over a Network

If you cannot print over a network, try these solutions:

- Make sure that your product is turned on.
- Make sure you install your product's network software as described in your product documentation, or contact your system administrator.

- Print a network status sheet and verify that the network settings are correct. If the network status is **Disconnected**, check any cable connections and turn your product off and then on again.
- Print a network connection report and check the codes and messages on the report to help determine the cause of the problem.
- If you are using TCP/IP, make sure the product's IP address is set correctly for your network. If your network does not assign IP addresses using DHCP, set the IP address manually.
- If the IP address assigned to the product is 169.254.XX.XX and the subnet mask is 255.255.0.0, the IP address may not be assigned correctly. Check the IP address and subnet mask assigned to the product (**Settings > General Settings > Network Settings > Advanced**) then restart the wireless router or reset the network settings for the product.
- Make sure your computer and product are both using the same wireless network.
- If you are trying to print using AirPrint, make sure **Paper Setup Auto Display** is enabled, and enable the **AirPrint** setting using Web Config.
- If network printing is slow, print a network status sheet and check the signal strength. If it is poor, place your product closer to your router or access point. Avoid placing your product near a microwave oven, cordless phone, or large metal object, such as a filing cabinet.

Note: If you are using a 5 GHz wireless router, set the router to operate in dual band (2.4 GHz and 5 GHz) mode. If your router uses a single network name (SSID) for both the 2.4 GHz and 5 GHz band, give each band its own network name (SSID) instead, such as Home Network 2.4 GHz and Home Network 5 GHz. See your router documentation or contact your internet service provider for instructions.

- Try restarting your router following the instructions in your router documentation.

Note: If you are reading these instructions online, you will lose your Internet connection when you restart your router.

- Check to see if your wireless router or access point has an enabled Privacy Separator function that is preventing printing from a device over the network. See your router or access point documentation for instructions on disabling the Privacy Separator function.
- If you are connecting the product via Wi-Fi Protected Setup (WPS) and the Wi-Fi icon on your product's LCD screen is not lit, make sure you select one of the WPS options from the product control panel within 2 minutes of pressing the WPS button on your router.

- Check your wired LAN router or access point to see if the LED for the port to which your product is connected is on or flashing. If the link LED is off, try the following:
 - Make sure the Ethernet cable is securely connected to your product and to your router, access point, switch, or hub.
 - Try connecting your product to a different port or a different router, access point, switch, or hub.
 - Try connecting with a different Ethernet cable.
 - Try printing to your product from another computer on the network.
- If you are connecting the product via EpsonNet Setup and the Wi-Fi icon does not appear lit on the LCD screen, make sure your product software was installed correctly. If necessary, reinstall your software.

Parent topic: [Solving Network Problems](#)

Related tasks

[Printing a Network Connection Report](#)

[Printing a Network Status Sheet](#)

Cannot Scan Over a Network

If you have problems scanning over a network, try these solutions:

- If you cannot scan from your product control panel, make sure you restarted your computer after installing the product software. Make sure the Event Manager program is not being blocked by your firewall or security software.

Note for Latin America: If you are using a 5 GHz wireless router, set the router to operate in dual band (2.4 GHz and 5 GHz) mode. If your router uses a single network name (SSID) for both the 2.4 GHz and 5 GHz band, give each band its own network name (SSID) instead, such as Home Network 2.4 GHz and Home Network 5 GHz. See your router documentation or contact your internet service provider for instructions.

- If you are scanning a large original at a high resolution, a network communication error may occur. Try scanning again at a lower resolution.
- If network communication was interrupted while starting Epson Scan 2, exit Epson Scan 2, wait a few seconds, and restart it. If Epson Scan 2 cannot restart, turn off your product, turn it back on, and try restarting Epson Scan 2 again.
- Check the scanner setting and reset the connection if necessary using Epson Scan 2 Utility:

Windows 11: Click , then search for **Epson Scan 2 Utility** and select it. Make sure your product is selected. If necessary, select the **Other** tab and click **Reset**.

Windows 10: Click  and select **EPSON > Epson Scan 2 Utility**. Make sure your product is selected. If necessary, select the **Other** tab and click **Reset**.

Windows 8.x: Navigate to the **Apps** screen, select **EPSON**, and select **Epson Scan 2 Utility**. Make sure your product is selected. If necessary, select the **Other** tab and click **Reset**.

Windows (other versions): Click  or **Start > All Programs** or **Programs > EPSON > Epson Scan 2 > Epson Scan 2 Utility**. Make sure your product is selected. If necessary, select the **Other** tab and click **Reset**.

Mac: Open the **Applications** folder, click **Epson Software**, and click **Epson Scan 2 Utility**. Make sure your product is selected. If necessary, select the **Other** tab and click **Reset**.

- You may need to disable the firewall and any anti-virus software on your wireless router or access point.
- Make sure the DNS settings and domain name are correct.

Parent topic: [Solving Network Problems](#)

Solving Network Security Problems

Check these sections if you have problems using the network security features.

[Cannot Create the Secure IPP Printing Port](#)

[Cannot Update a Certificate or Create a CSR](#)

[Cannot Import a Digital Certificate](#)

[Deleted a CA-signed Certificate](#)

[Digital Certificate Warning Messages](#)

Parent topic: [Solving Problems](#)

Cannot Create the Secure IPP Printing Port

If you cannot create the secure IPP printing port, try these solutions:

- Make sure you specified the correct server certificate for SSL/TLS communication using Web Config.
- If you are using a CA certificate, make sure it is imported to the computer that is accessing the product.

Parent topic: [Solving Network Security Problems](#)

Related tasks

[Importing a CA Certificate](#)

Related topics

[Configuring SSL/TLS Communication](#)

Cannot Update a Certificate or Create a CSR

If you cannot update a self-signed certificate or create a CSR for a CA-signed certificate, try these solutions:

- Make sure that you entered a **Common Name** setting in Web Config.
- Make sure the **Common Name** setting does not contain unsupported characters or is divided by a comma. Correct the setting and update the certificate again.

Parent topic: [Solving Network Security Problems](#)

Related references

[CSR Setup Settings](#)

[CSR Import Settings](#)

Related tasks

[Obtaining and Importing a CA-signed Certificate](#)

Cannot Import a Digital Certificate

If you cannot import a digital certificate, try these solutions:

- Make sure the CA-signed certificate and the CSR have the same information. If they do not match, import the certificate to a device that matches the information or use the CSR to obtain the CA-signed certificate again.
- Make sure the CA-signed certificate file size is 5KB or less.
- Make sure you are entering the correct password.

Parent topic: [Solving Network Security Problems](#)

Related references

[CSR Setup Settings](#)

[CSR Import Settings](#)

Related tasks

[Obtaining and Importing a CA-signed Certificate](#)

Deleted a CA-signed Certificate

If you accidentally deleted a CA-signed certificate, try these solutions:

- If you retained a backup file, import the CA-signed certificate again.
- If you obtained the certificate using a CSR created in Web Config, you cannot import a deleted certificate. Create a new CSR and obtain a new certificate.

Parent topic: [Solving Network Security Problems](#)

Related references

[CSR Setup Settings](#)

[CSR Import Settings](#)

Related tasks

[Obtaining and Importing a CA-signed Certificate](#)

Digital Certificate Warning Messages

If you see a warning message when using a digital certificate, check for solutions in this table.

Message	Solution
Enter a Server Certificate.	Select a certificate file and click Import .
CA Certificate 1 is not entered.	Import CA certificate 1 before importing additional certificates.
Invalid value below.	Remove any unsupported characters in the file path and password.
Invalid date and time.	Set the date and time on the product using Web Config, EpsonNet Config, or the product control panel.
Invalid password	Enter the password that matches the password set for the CA certificate.

Message	Solution
Invalid file	Try the following: <ul style="list-style-type: none"> • Import only certificate files in X509 format sent by a trusted certificate authority. • Make sure the file size is 5KB or less and is not corrupted or fabricated. • Make sure the chain in the certificate is valid; check the certificate authority's website.
Cannot use the Server Certificates that include more than three CA certificates.	Import certificate files in PKCS#12 format that contains one or two CA certificates, or convert each certificate to PRM format and import them again.
The certificate has expired. Check if the certificate is valid, or check the date and time on your printer.	Make sure the product time and date are set correctly and, if the certificate is out of date, obtain and import a new certificate.
Private key is required.	Do one of the following to pair a private key with the certificate: <ul style="list-style-type: none"> • For PEM/DER format certificates obtained from a CSR using a computer, specify the private key file. • For PKCS#12 format certificates obtained from a CSR using a computer, create a file containing the private key. If you re-imported a PEM/DER format certificate obtained from a CSR using Web Config, you can only import it once. You must obtain and import a new certificate.
Setup failed.	Make sure the computer and product are connected, and the certificate file is not corrupted, then import the certificate file again.

Parent topic: [Solving Network Security Problems](#)

Related tasks

[Obtaining and Importing a CA-signed Certificate](#)

[Synchronizing the Date and Time with a Time Server](#)
[Selecting the Date and Time](#)

Solving Copying Problems

Check these solutions if you have problems copying with your product.

[Product Cannot Copy](#)

[Product Makes Noise, But Nothing Copies](#)

[Product Makes Noise When It Sits for a While](#)

Parent topic: [Solving Problems](#)

Product Cannot Copy

If your product cannot make copies, try these solutions:

- If user restriction has been enabled, you may need to enter a user name and password. Contact your administrator for assistance.
- If the product has an error, such as a paper jam, you cannot make copies. Check the LCD screen for any errors, and follow the onscreen instructions to clear the error.

Parent topic: [Solving Copying Problems](#)

Related topics

[Restricting Features Available for Users](#)

Product Makes Noise, But Nothing Copies

If your product makes a noise, but nothing copies, try these solutions:

- Run a nozzle check to see if any of the print head nozzles are clogged. Then clean the print head, if necessary.
- If the nozzle check page does not print, but the product's power is on, make sure your product software is installed correctly.
- Make sure your product is level (not tilted).

Parent topic: [Solving Copying Problems](#)

Related tasks

[Checking the Nozzles Using the Product Control Panel](#)

[Cleaning the Print Head Using the Product Control Panel](#)

Product Makes Noise When It Sits for a While

Your product is performing routine maintenance. This is normal.

Parent topic: [Solving Copying Problems](#)

Solving Copy Quality Problems

Check these sections if your copies have a quality problem.

[Copies Have Incorrect or Faint Colors](#)

[Position, Size, or Margins of Copies are Incorrect](#)

Parent topic: [Solving Problems](#)

Copies Have Incorrect or Faint Colors

If your copies have incorrect, uneven, smeared, or faint colors, try these solutions:

- Run a print head nozzle check to see if any of the nozzles are clogged. Then clean the print head, if necessary.
- Do not press too hard on the original when you copy from the scanner glass.
- Clean the scanner glass with a soft, dry, lint-free cloth or use a small amount of glass cleaner on the cloth, if necessary. Paper towels are not recommended.

Caution: Do not spray glass cleaner directly on the scanner glass.

- Clean the ADF.
- Wipe any dirt or dust off of your originals.
- If the colors are smeared, try lowering the copy density setting on the LCD screen.
- Make sure your paper is not curled.
- When vertical banding appears or the paper is smeared, clean the paper path.
- When horizontal banding appears or the top or bottom of the paper is smeared, load paper in the correct direction and slide the edge guides to the edges of the paper.
- When copying on thick paper, select a **Thick Paper** setting from the control panel (**Settings > General Settings > Printer Settings > Thick Paper**). When this setting is enabled, copy quality may decline and copy speed may decrease.

Parent topic: [Solving Copy Quality Problems](#)

Related tasks

[Checking the Nozzles Using the Product Control Panel](#)

[Cleaning the Print Head Using the Product Control Panel](#)

Position, Size, or Margins of Copies are Incorrect

If the position, size, or margins of your copies are incorrect, try these solutions:

- When placing originals in the ADF, make sure the edge guides are against the edges of the paper.
- When placing originals on the scanner glass, make sure the original is placed correctly for scanning. Align the corner of the original with the corner indicated by the symbol on the scanner glass. If necessary, move the original away from the edges of the scanner glass slightly.
- If the original is folded or wrinkled, use the scanner glass. Flatten any folds or wrinkles in the original and try using another sheet or card to keep the original in contact with the scanner glass.
- Clean the scanner glass and ADF.
- Make sure the paper is loaded in the correct direction.
- Select the appropriate original size copy setting on the LCD screen.

Parent topic: [Solving Copy Quality Problems](#)

Solving Paper Problems

Check these sections if you have problems using paper with your product.

[Paper Feeding Problems](#)

[Originals Do Not Feed From the Automatic Document Feeder](#)

[Paper Jam Problems](#)

[Paper Ejection Problems](#)

Parent topic: [Solving Problems](#)

Paper Feeding Problems

If you have problems feeding paper, try these solutions:

- Make sure the paper cassette is inserted all the way in the printer.
- Make sure the paper type setting matches the type of paper you loaded.
- If paper does not feed correctly, remove and reload it in the cassette and adjust the edge guides. Make sure the paper stack is not above the tab on the edge guides inside the cassette.
- If multiple pages feed at once, remove the paper, fan the edges to separate the sheets, and reload it.

- If multiple sheets continue to feed at once, load one sheet of paper at a time or load new paper.
- Do not load more than the recommended number of sheets.
- Make sure your paper meets the specifications for your product.
- If paper jams when you print on both sides of the paper, try loading fewer sheets.
- If a paper out error occurs when paper is loaded in the paper tray, reload the paper in the center of the paper tray.
- For best results, follow these guidelines:
 - Use new, smooth, high-quality paper that is not curled, creased, old, too thin, or too thick.
 - Load paper in the cassette printable side down.
 - Load paper in the correct direction and slide the edge guides against the edges of the paper.
 - Follow any special loading instructions that came with the paper.

Note: Your product will not operate properly while tilted at an angle. Place it on a flat, stable surface that extends beyond the base of the product in all directions.

- Clean the paper rollers.
- Operate your product in the recommended environmental conditions.

Parent topic: [Solving Paper Problems](#)

Related references

[Paper Specifications](#)

[Paper Loading Capacity](#)

Originals Do Not Feed From the Automatic Document Feeder

If your originals do not feed when placed in the ADF, try these solutions:

- Make sure the **ADF** icon lights up on the Copy, Fax, or Scan screen on the LCD screen. If not, reload the originals.
- Make sure the size, weight, and number of your originals are supported by the ADF.
- Make sure the originals are loaded correctly.
- Slide the edge guides against the edges of the originals.
- Make sure the document is not curled or creased.
- Try cleaning the inside of the ADF.

- Do not load originals above the arrow mark on the ADF edge guide.

Parent topic: [Solving Paper Problems](#)

Related references

[Automatic Document Feeder \(ADF\) Specifications](#)

Paper Jam Problems

If a paper jam occurs in the product, a message appears on the LCD screen. Follow the on-screen instructions to locate the paper jam and remove the paper.

Caution: Never touch the buttons on the control panel while your hand is inside the product. If the product starts operating, it could cause an injury. Be careful not to touch the protruding parts to avoid injury. Remove the jammed paper carefully or you may damage the product.

Caution: When using the optional hole punch unit with the optional staple or booklet finisher, adjust the printed area so it does not overlap with the holes being punched. You should also set the binding margin so that it is not printed at the hole punch position. Punching holes over any printed area may cause hole punch failure or a paper jam.

Parent topic: [Solving Paper Problems](#)

Related references

[Finishing Options - Windows](#)

[Finishing Options - Mac](#)

Paper Ejection Problems

If you have problems with paper ejecting properly, try these solutions:

- If paper does not eject fully, you may have set the wrong paper size. Cancel printing to eject the paper. Select the correct paper size when you reprint.
- If paper falls from the output tray, extend the paper stopper.
- If paper is wrinkled when it ejects, it may be damp or too thin. Load new paper and be sure to select the correct paper type setting when you reprint.
- If you are using letterhead paper, select the appropriate paper type setting.
- Clean the roller inside the printer to remove any dust on the paper path.
- If you are using the staple finisher, make sure to remove any scraps of paper left inside the unit and clear any objects around the unit.

Parent topic: [Solving Paper Problems](#)

Solving Problems Printing from a Computer

Check these sections if you have problems while printing from your computer.

Note: When printing using AirPrint, the available print settings are different from those covered in this manual. See the Apple website for details.

Note: For problems while printing with the Epson Universal Print Driver or PostScript (PS3) printer software, see the sections covering that software in this manual.

[Nothing Prints](#)

[Product Icon Does Not Appear in Windows Taskbar](#)

[Printing is Slow](#)

Parent topic: [Solving Problems](#)

Related topics

[Printing with the Epson Universal Print Driver - Windows](#)



[Printing with the PostScript \(PS3\) Printer Software - Windows](#)

[Printing with the PostScript \(PS3\) Printer Software - Mac](#)

Nothing Prints

If you have sent a print job and nothing prints, try these solutions:

- Make sure your product is turned on and connected to your computer.
- Make sure any interface cables are connected securely at both ends.
- Make sure there are no errors or paper jams in the product.
- There may be a problem with the printer's status. Click **EPSON Status Monitor 3** on the printer driver's Maintenance tab, and then check the printer status. If EPSON Status Monitor 3 is disabled, click **Extended Settings** on the Maintenance tab, and then select **Enable EPSON Status Monitor 3**.
- If you connected your product to a USB hub, make sure it is a first-tier hub. If it still does not print, connect your product directly to your computer instead of the hub.
- If the printer cannot print using a USB connection, disconnect the USB cable from the computer, right-click on the printer icon displayed on the computer, and select **Remove Device**. Then connect the USB cable to the computer and try a test print.

- If your computer is connected using a USB cable, try a different USB port on your computer or a different cable.
- Make sure the printer status is not offline or pending.
- Make sure you are using the Epson printer driver for your product or the available functions are limited.
- Run a product check to see if a test page prints. If the test page prints, check to see if your product software is installed correctly.
- Make sure your system meets the requirements for your operating system. If you are printing a high-resolution image, you may need more than the minimum requirements. Print the image at a lower resolution or if necessary, increase your system's memory.
- In Windows, make sure your product is selected as the default printer and the printer port setting matches the printer connection port.
- In Windows, delete all jobs from the Windows Spooler. Click **Print Queue** on the Maintenance tab in the printer settings window, and cancel any stalled print jobs.
- In Windows, do one of the following to open the Epson Printer Connection Checker and follow the on-screen instructions to check the connection status:
 - **Windows 11:** Click , then search for **Epson Printer Connection Checker** and select it.
 - **Windows 10:** Click  and select **Epson Software > Epson Printer Connection Checker**.
 - **Windows 8.x:** Navigate to the **Apps** screen and select the **Epson Printer Connection Checker** icon.
 - **Windows 7:** Click  and select **All Programs > Epson Software > Epson Printer Connection Checker**.
- On a Mac, make sure the printer is added to the printer list and the printer is not paused.
- Make sure the printing language setting on the control panel is correct.
- Make sure your product is selected as the printer in your printing program.
- You can try to clear the problem by updating the product software to the latest version. If the problem persists, try uninstalling and reinstalling the printer driver.

Parent topic: [Solving Problems Printing from a Computer](#)

Related references

[Windows System Requirements](#)

[Mac System Requirements](#)

Related tasks





[Running a Product Check](#)

[Checking for Software Updates](#)

Product Icon Does Not Appear in Windows Taskbar

If you do not see your product icon in the Windows taskbar, first try restarting your computer. If that does not work, try this solution:

1. Do one of the following:

- **Windows 11:** Click , search for **Settings** and select it. Select **Bluetooth & devices > Printers & scanners**. Select your product name and select **Printing preferences**.
- **Windows 10:** Click  and select  (Settings) > **Devices > Printers & scanners**. Select your product name and select **Manage > Printing preferences**.
- **Windows 8.x:** Navigate to the **Apps** screen and select **Control Panel > Hardware and Sound > Devices and Printers**. Right-click your product name, select **Printing Preferences**, and select your product name again if necessary.
- **Windows 7:** Click  and select **Devices and Printers**. Right-click your product name, select **Printing Preferences**, and select your product name again if necessary.

2. Click the **Maintenance** tab.

3. Click the **Extended Settings** button.

4. Select **Enable EPSON Status Monitor 3** and click **OK**.

5. Click the **Monitoring Preferences** button.

6. Click the checkbox for the option that adds the shortcut icon to the taskbar.

7. Click **OK** to close the open program windows.

Parent topic: [Solving Problems Printing from a Computer](#)

Related topics

[Printing with the Epson Universal Print Driver - Windows](#)

[Printing with the PostScript \(PS3\) Printer Software - Windows](#)

[Printing with the PostScript \(PS3\) Printer Software - Mac](#)

Printing is Slow

If printing becomes slow, try these solutions:

- Make sure your system meets the requirements for your operating system. If you are printing a high-resolution image, you may need more than the minimum requirements. If necessary, increase your system's memory.
- If you are using Windows 7, close the **Devices and Printers** window before you print.
- On a Mac, make sure you download and install the Epson printer driver.
- Make sure **Quiet Mode** is turned off.
- Clear space on your hard drive or run a defragmentation utility to free up existing space.
- Close any programs you are not using when you print.
- If your product is connected to a USB hub, connect it directly to your computer instead.
- If printing becomes slower after printing continuously for a long time, the product may have automatically slowed down to protect the print mechanism from overheating or becoming damaged. Let the product rest with the power on for 30 minutes, then try printing again.

For the fastest printing, select the following settings in your product software:

- Make sure the paper type setting matches the type of paper you loaded.
- Turn on any high speed settings in your product software.
- Select a lower print quality setting.
- Make sure the ink drying time has not been increased for double-sided printing.
- **Windows:** Click the **Maintenance** or **Utility** tab, select **Extended Settings** or **Speed and Progress**, and select the following settings:
 - **Always Spool RAW Datatype**
 - **Page Rendering Mode**
 - **Print as Bitmap**
- **Mac:** Select **System Preferences** or **System Settings**, select **Printers & Scanners**, and select your product. Select **Options & Supplies**, select **Options** (or **Driver**), and enable the **Bidirectional printing** setting.

If printing is still slow and you are using Windows 7 or Windows Vista, try the following:

1. Click  and select **Computer** or **My Computer**. Double-click the **C:** drive and open these folders:
ProgramData > EPSON > PRINTER.

Note: If you do not see the ProgramData folder, open the **Organize** menu and select **Folder and search options**. In the window that appears, click the **View** tab, select **Show hidden files, folders, and drives** in the Advanced settings list, and click **OK**.

2. Right-click the **EPAUDF01.AUD** file and select **Delete**.
3. Restart your computer and try printing again.

Parent topic: [Solving Problems Printing from a Computer](#)

Related topics

[Printing with the Epson Universal Print Driver - Windows](#)

[Printing with the PostScript \(PS3\) Printer Software - Windows](#)

[Printing with the PostScript \(PS3\) Printer Software - Mac](#)

Solving Page Layout and Content Problems

Check these sections if you have problems with the layout or content of your printed pages.

Note: When printing using AirPrint, the available print settings are different from those covered in this manual. See the Apple website for details.

[Inverted Image](#)

[Too Many Copies Print](#)

[Blank Pages Print](#)

[Incorrect Margins on Printout](#)

[Incorrect Characters Print](#)

[Incorrect Image Size or Position](#)

[Slanted Printout](#)

Parent topic: [Solving Problems](#)

Inverted Image

If your printed image is inverted unexpectedly, try these solutions:

- Turn off any mirror or inversion settings in your printing application.
- Turn off the **Mirror Image**, **Flip horizontally**, or **Reverse page orientation** settings in your printer software. (This option has different names, depending on your operating system version.)

Parent topic: [Solving Page Layout and Content Problems](#)

Too Many Copies Print

Make sure that the **Copies** setting in your printing program or printer software is not set for multiple copies.

Parent topic: [Solving Page Layout and Content Problems](#)

Blank Pages Print

If blank pages print unexpectedly, try these solutions:

- Make sure you selected the correct paper size settings in your printing program and printer software.
- If a blank page exists in a document you are printing and you want to skip printing it, select the **Skip Blank Page** setting in your printer software, if available.
- Run a print head nozzle check to see if any of the nozzles are clogged. Then clean the print head, if necessary.
- Make sure your product is selected as the printer in your printing program.
- Make sure your product is on a flat surface and operating in the recommended environmental conditions or multiple sheets of paper may be fed at the same time.

Parent topic: [Solving Page Layout and Content Problems](#)

Related references

[Environmental Specifications](#)

Related tasks

[Checking the Nozzles Using the Product Control Panel](#)

[Selecting Basic Print Settings - Windows](#)

[Selecting Basic Print Settings - Mac](#)

Incorrect Margins on Printout

If your printed page has incorrect margins, try these solutions:

- Make sure you selected the correct paper size settings in your printing program and printer software.
- Make sure you selected the correct margins for your paper size in your printing program.
- Make sure your paper is positioned correctly for feeding into the product.
- Clean the scanner glass and the document cover. If there is dust or stains on the glass, the copy area may extend to include the dust or stains.
- Load paper in the correct direction and slide the edge guides against the edges of the paper.

- Select the appropriate original size in the copy settings.

You can use the preview option in your printer software to check your margins before you print.

Parent topic: [Solving Page Layout and Content Problems](#)

Incorrect Characters Print

If incorrect characters appear in your prints, try these solutions before reprinting:

- Make sure any cables are securely connected at both ends.
- In Windows, delete all jobs from the Windows Spooler. Click **Print Queue** on the Maintenance tab in the printer settings window, and cancel any stalled print jobs.
- On a Mac, cancel any paused print jobs.
- If your product is connected to a USB hub, connect it directly to your computer instead.
- If incorrect characters still appear in your prints, try connecting your product using a different cable.
- If your computer entered sleep mode the last time you printed, the next print job after your computer exits sleep mode may contain garbled characters. Print your document again.
- Make sure you are using the printer software for this product. Check the product name at the top of the driver window.
- If you are using the Windows PostScript printer software, the product cannot print binary data if it is connected to the computer using a USB cable. Try selecting **ASCII** or **TBCP** as the **Output Protocol** setting on the Device Settings tab in the printer properties.
- If you are using the Windows PostScript printer software, select the appropriate substitution fonts on the Device Settings tab in the printer properties.

Parent topic: [Solving Page Layout and Content Problems](#)

Incorrect Image Size or Position

If your printed image is the wrong size or in the wrong position, try these solutions:

- Make sure you selected the correct paper size and layout settings in your printing program and printer software.
- Make sure you selected the correct paper size on the control panel.
- Make sure your paper is positioned correctly for feeding into the printer.
- Slide the edge guides against the edges of the paper.
- Clean the scanner glass and document cover.

- If the edges of a copy are cropped, slightly move the original away from the edges of the scanner glass.
- Make sure you selected the correct margins for your paper size in your printing program.
- Be sure to select the appropriate original size setting for your original in the copy settings.

You can use the preview option in your printer software to check your margins before you print.

Parent topic: [Solving Page Layout and Content Problems](#)

Related tasks

[Selecting Basic Print Settings - Windows](#)

[Selecting Basic Print Settings - Mac](#)

Slanted Printout

If your printouts are slanted, try these solutions:

- Make sure the paper is loaded in the correct direction.
- Make sure your paper meets the specifications for your product.
- Do not load more than the recommended number of sheets.
- Slide the edge guides against the edges of the paper.
- Select a higher print quality setting in your printer software.
- Turn off any high speed settings in your product software.
- Disable the **Bidirectional Printing** setting.
- Make sure the product is not printing while tilted or at an angle.

Parent topic: [Solving Page Layout and Content Problems](#)

Related references

[Environmental Specifications](#)

[Paper Loading Capacity](#)

[Paper Loading Orientation](#)

Related tasks

[Loading Paper in the Cassettes and Paper Tray](#)

Solving Print Quality Problems

Check these sections if your printouts have problems with print quality, but your image looks fine on your computer screen.

Note: When printing using AirPrint, the available print settings are different from those covered in this manual. See the Apple website for details.

[White or Dark Lines in Printout](#)

[Blurry or Smearred Printout](#)

[Faint Printout or Printout Has Gaps](#)

[Grainy Printout](#)

[Incorrect Colors](#)

Parent topic: [Solving Problems](#)

White or Dark Lines in Printout

If you notice white or dark lines in your prints (also called banding), try these solutions before you reprint:

- Run a nozzle check to see if any of the print head nozzles are clogged. Then clean the print head, if necessary.
- Make sure the paper type setting matches the type of paper you loaded.
- Make sure you loaded the printable side of the paper correctly for your product.
- Turn off any high speed settings in your product software.
- Disable the bidirectional (high speed) setting.
- Adjust the print quality in the product software.
- When horizontal banding appears or the top or bottom of the paper is smeared, load paper in the correct direction and slide the edge guides to the edges of the paper.
- If you are copying from the ADF, copy from the scanner glass instead or use a higher quality setting.
- You may need to replace the ink cartridges.

Parent topic: [Solving Print Quality Problems](#)

Related references

[Paper Loading Orientation](#)

Related tasks

[Selecting Basic Print Settings - Windows](#)

[Selecting Basic Print Settings - Mac](#)

[Removing and Installing Ink Cartridges](#)

Blurry or Smearred Printout

If your printouts are blurry or smearred, try these solutions:

- Make sure your paper is not damp, curled, old, or loaded incorrectly in your product.
- Slide the edge guides to the edges of the paper.
- Use a support sheet with special paper, or load special paper one sheet at a time.
- Place a piece of black paper on the back of the original and copy it again.
- Make sure your paper meets the specifications for your product.
- Use Epson papers to ensure proper saturation and absorption of genuine Epson inks.
- If printouts are frequently smearred or scuffed, try using new paper.
- Do not load more than the recommended number of sheets. For plain paper, do not load above the line indicated by the triangle symbol on the edge guide.
- Make sure the paper type setting in your product software matches the type of paper you loaded.
- Make sure you loaded the printable side of the paper correctly for your product.
- If you are printing on thick paper or envelopes, turn on the **Thick Paper** setting from the control panel or select **Thick Paper and Envelopes** in the Extended Settings of the printer software. (Turning this setting on will decrease print speed.)
- If you are printing on thick paper, select a thick paper **Paper Type** setting on the control panel.
- If paper is still smearred after enabling settings for thick paper, reduce the print density.
- If you are printing on thick paper or envelopes, make sure you select the appropriate settings.
- Remove each sheet from the output tray as it is printed.
- Avoid handling printouts on glossy paper right after printing to allow the ink to set.
- Dry printouts completely before filing or displaying them. When drying printouts, avoid direct sunlight, do not use a dryer, and do not touch the printed side of the paper.
- Do not stack printouts immediately after printing.
- Turn off any high speed settings in your product software.
- When vertical banding appears or the paper is smearred, clean the paper path.
- When horizontal banding appears or the top or bottom of the paper is smearred, load paper in the correct direction and slide the edge guides to the edges of the paper.
- If you print on both sides of a sheet of paper, smudges may appear on the reverse side of heavily saturated or dark images. If one side of a sheet will contain a lighter image or text, print that side first.

Make sure the ink has dried before reloading the paper to print on the other side. Adjust the density and/or ink drying time settings.

- Lower the copy density setting on the product control panel.
- Run a nozzle check to see if any of the print head nozzles are clogged. Then clean the print head, if necessary.
- Adjust the print quality in the product software.
- Clean the paper path.
- Clean the paper rollers.

Note: Your product will not operate properly while tilted at an angle. Place it on a flat, stable surface that extends beyond the base of the product in all directions.

Parent topic: [Solving Print Quality Problems](#)

Related references

[Paper Specifications](#)

[Paper Loading Capacity](#)

[Paper Loading Orientation](#)

Related tasks

[Checking the Nozzles Using the Product Control Panel](#)

[Cleaning the Print Head Using the Product Control Panel](#)

Faint Printout or Printout Has Gaps

If your printouts are faint or have gaps, try these solutions:

- Run a nozzle check to see if any of the print head nozzles are clogged. Then clean the print head, if necessary.
- The ink cartridges may be old or low on ink, and you may need to replace them.
- Make sure the paper type setting matches the type of paper you loaded.
- Make sure your paper is not damp, curled, old, or loaded incorrectly in your product.
- When copying, increase the **Density** setting on the product control panel.
- Adjust the print quality in the product software.
- Clean the paper path.
- Clean the paper rollers.

- If you are printing a file that was saved in Storage from a computer, re-save the file to Storage and select a higher quality setting in your Windows printer driver. On the **Main** tab, select **More Settings** from the **Quality** drop-down menu, and then select **Quality**.

Parent topic: [Solving Print Quality Problems](#)

Related tasks

[Checking the Nozzles Using the Product Control Panel](#)

[Cleaning the Print Head Using the Product Control Panel](#)

[Removing and Installing Ink Cartridges](#)

Grainy Printout

If your printouts are grainy, try these solutions:

- Make sure you loaded the printable side of the paper correctly for your product.
- Select a higher print quality setting and turn off any high speed settings in your product software.
- Run a nozzle check to see if any of the print head nozzles are clogged. Then clean the print head, if necessary.
- Adjust the print quality in the product software.
- You may need to increase the image resolution or print a smaller size; see your software documentation.

Note: Images from the Internet may be low resolution and not result in a high quality printout.

- If you enlarged the image size in an image-editing program, you need to increase the image resolution setting to retain a high image quality. Increase the image resolution by the same amount you increase the image size. For example, if the image resolution is 300 dpi (dots per inch) and you will double the image size for printing, change the resolution setting to 600 dpi.

Note: Higher resolution settings result in larger file sizes, which take longer to process and print. Consider the limitations of your computer system when selecting a resolution, and select the lowest possible resolution that produces acceptable quality to keep file sizes manageable.

Parent topic: [Solving Print Quality Problems](#)

Incorrect Colors

If your printouts have incorrect colors, try these solutions:

- Make sure the paper type setting matches the paper you loaded.
- Make sure the **Grayscale** setting is not selected in your printer software.
- Select **EPSON Standard** as the **Color Mode** (Windows) or **Mode** (Mac) setting in the printer software.
- Run a nozzle check to see if any of the print head nozzles are clogged. Then clean the print head, if necessary.
- The ink cartridges may be old or low on ink, and you may need to replace them.
- After you print, the colors in your printout need time to set as the ink dries. During this time, the colors may look different than you expect. To speed up drying time, do not stack your printouts on top of each other.
- Your printed colors can never exactly match your on-screen colors. However, you can use a color management system to get as close as possible. Try using the color management options in your printer software.
- Select **Custom** as the **Color Correction** setting on the More Options tab of the printer software, then click **Advanced**. Try changing the **Scene Correction** setting to something other than **Automatic**. If changing that setting does not work, change the **Color Management** setting to any color correction method other than **PhotoEnhance**.
- If you are using a Mac, select **ColorSync** from the **Color Matching** menu of the driver.
- If you are using the Windows PostScript printer software, try adjusting the **Color Mode** setting on the Advanced tab of the printer software.
- If you are using the PostScript printer driver and the file you are printing was created in an application that allows you to change the data format, make sure the settings in the application match the settings in the printer driver.
- For best results, use genuine Epson paper.
- Remove any dust or dirt on the originals and clean the scanner glass.
- Do not press with too much force on the original or the document cover.
- If you are copying an original, lower the **Density** setting.

Parent topic: [Solving Print Quality Problems](#)

Related references

[Paper Loading Orientation](#)

[Compatible Epson Papers \(U.S. and Canada\)](#)

[Compatible Epson Papers \(Latin America\)](#)

[Windows System Requirements](#)

[Mac System Requirements](#)

Related tasks

[Cleaning the Scanner Glass](#)

Solving Scanning Problems

Check these solutions if you have problems scanning with your product.

[Scanning Software Does Not Operate Correctly](#)

[Cannot Start Epson Scan 2](#)

Parent topic: [Solving Problems](#)

Scanning Software Does Not Operate Correctly

If your scanning software does not operate correctly, try these solutions:

- Make sure your computer has adequate memory and meets the system requirements for your operating system.
- Make sure your computer is not running in a power-saving mode, such as sleep or standby. If so, wake your system and restart your scanning software.
- If you upgraded your operating system but did not reinstall your scanning software, try reinstalling it.
- In Windows, make sure your product is listed as a valid device in the **Scanners and Cameras** control panel.

Parent topic: [Solving Scanning Problems](#)

Cannot Start Epson Scan 2

If you cannot start Epson Scan 2, try these solutions:

- Make sure your product is turned on and any interface cables are securely connected at both ends.
- If your product is connected to a USB hub, connect it directly to your computer instead.
- Make sure Epson Scan 2 is selected as your scanning program.
- Make sure your computer is not running in a power-saving mode, such as sleep or standby. If so, wake your system and restart Epson Scan 2.
- Check the connection setting and test the connection using Epson Scan 2 Utility:

Windows 11: Click , search for **Epson Scan 2 Utility** and select it. Make sure the correct product is selected. If necessary, select the **Other** tab and click **Reset**.

Windows 10: Click  and select **EPSON > Epson Scan 2 Utility**. Make sure the correct product is selected. If necessary, select the **Other** tab and click **Reset**.

Windows 8.x: Navigate to the **Apps** screen and select **Epson Scan 2 Utility**. Make sure the correct product is selected. If necessary, select the **Other** tab and click **Reset**.

Windows (other versions): Click  or **Start > All Programs** or **Programs > EPSON > Epson Scan 2 > Epson Scan 2 Utility**. Make sure the correct product is selected. If necessary, select the **Other** tab and click **Reset**.

Mac: Open the **Applications** folder, click **Epson Software**, and click **Epson Scan 2 Utility**. Make sure the correct product is selected. If necessary, select the **Other** tab and click **Reset**.

- Make sure you do not have multiple versions of Epson Scan 2 installed. If you do, uninstall both versions and install one version.
- If you upgraded your operating system but did not reinstall Epson Scan 2, try reinstalling it.
- If the user restriction feature (Access Control) is enabled, a user ID and password are required to scan. If you do not know the user ID or password, contact your administrator for assistance.

Parent topic: [Solving Scanning Problems](#)

Related topics

[Restricting Features Available for Users](#)

Solving Scanned Image Quality Problems

Check these sections if a scanned image on your computer screen has a quality problem.

Note: For solutions when using Document Capture Pro (Windows) or Document Capture (Mac) software, see the Document Capture Pro (Windows) or Document Capture (Mac) help utility.

[Image Consists of a Few Dots Only](#)

[Line of Dots Appears in All Scanned Images](#)

[Straight Lines in an Image Appear Crooked](#)

[Scanned Image Quality Problems](#)

[Image Colors are Patchy at the Edges](#)

[Ripple Patterns Appear in an Image](#)

[Scanned Image Edges are Cropped](#)

Parent topic: [Solving Problems](#)

Image Consists of a Few Dots Only

If your scanned image consists only of a few dots, try these solutions:

- Make sure you placed your original for scanning facing the correct way.
- If the **Image Type** setting is **Black & White**, adjust the **Threshold** and scan again.
- Remove any lint or dirt from your original.
- Clean the scanner glass.
- Do not press on the original or the document cover with too much force.

Parent topic: [Solving Scanned Image Quality Problems](#)

Related tasks

[Cleaning the Scanner Glass](#)

[Placing Originals on the Scanner Glass](#)

Line of Dots Appears in All Scanned Images

If a line of dots appears in all your scanned images, try these solutions:

- Clean the scanner glass with a soft, dry, lint-free cloth or use a small amount of glass cleaner on the cloth, if necessary. Paper towels are not recommended.

Caution: Do not spray glass cleaner directly on the scanner glass.

- Make sure any interface cables are securely connected at both ends.
- Remove any dust or dirt that may have adhered to your original.
- Do not press with too much force on the original or the document cover.
- Keep the document cover closed to prevent dirt or dust from getting inside.

If you are scanning from the ADF, make sure the ADF edge guides fit against the loaded originals. You can also try cleaning the ADF and scanning again.

Parent topic: [Solving Scanned Image Quality Problems](#)

Related tasks

[Cleaning the Scanner Glass](#)

[Placing Originals in the Automatic Document Feeder](#)

Straight Lines in an Image Appear Crooked

If straight lines in an original appear crooked in a scanned image, make sure to place your original straight when you scan it.

Clean the scanner glass with a soft, dry, lint-free cloth or use a small amount of glass cleaner on the cloth, if necessary. Paper towels are not recommended.

If you are scanning from the ADF, make sure the ADF edge guides fit against the loaded originals. You can also try cleaning the ADF and scanning again.

Parent topic: [Solving Scanned Image Quality Problems](#)

Related tasks

[Cleaning the Automatic Document Feeder](#)

[Cleaning the Scanner Glass](#)

[Placing Originals on the Scanner Glass](#)

[Placing Originals in the Automatic Document Feeder](#)

Scanned Image Quality Problems

If you encounter quality problems with your scanned image, try these solutions:

Image is Distorted or Blurry

- Make sure your original is not wrinkled or warped. This may prevent the original from laying flat on the scanner glass.
- Do not move your original or your product during scanning.
- Clean the scanner glass and the ADF and remove any dirt or dust on your originals.
- Do not press on the document cover or the original with too much force.
- Your product will not operate properly while tilted at an angle. Place your product on a flat, stable surface that extends beyond its base in all directions.
- Adjust these Epson Scan 2 settings (if available) and try scanning again:
 - Make sure you select the correct **Image Type** for your original.
 - Increase the **Resolution** setting.
 - If the **Image Type** setting is **Black & White**, adjust the **Threshold** setting.
 - If the **Image Type** setting is **Color** or **Grayscale**, select the **Unsharp Mask** setting.
 - If the **Image Type** setting is **Black & White**, select **Text Enhancement**. If the **Image Type** setting is **Color** or **Grayscale**, change the **Text Enhancement** setting to **High**.

Image is Too Dark

- If the **Image Type** is set to **Color** or **Grayscale**, adjust the **Brightness** setting.
- Check the brightness and contrast settings of your computer monitor.

Back of Original Image Appears in Scanned Image

- Place a piece of black paper on the back of the original and scan it again.
- Lower the copy density setting.
- Adjust these Epson Scan 2 settings (if available) and try scanning again:
 - Make sure you select the correct **Image Type** for your original.
 - Select the **Advanced Settings** tab and adjust the **Brightness** setting.

Scanned Image Colors Do Not Match Original Colors

Printed colors can never exactly match the colors on your computer monitor because printers and monitors use different color systems: monitors use RGB (red, green, and blue) and printers typically use CMYK (cyan, magenta, yellow, and black).

Check the color matching and color management capabilities of your computer, display adapter, and the software you are using to see if they are affecting the palette of colors you see on your screen.

Remove any dust or dirt from your originals and clean the scanner glass. Do not press with too much force on the original or document cover.

To adjust the colors in your scanned image, adjust these Epson Scan 2 settings (if available) and try scanning again:

- Make sure you select the correct **Image Type** for your original.
- If the **Image Type** setting is **Color** or **Grayscale**, adjust the **Contrast** setting.
- If the **Image Type** setting is **Black & White** or **Grayscale**, adjust the **Color Enhance** setting.

Parent topic: [Solving Scanned Image Quality Problems](#)

Related tasks

[Cleaning the Automatic Document Feeder](#)

[Cleaning the Scanner Glass](#)

[Placing Originals on the Scanner Glass](#)

[Placing Originals in the Automatic Document Feeder](#)

Image Colors are Patchy at the Edges

If you are scanning a thick or warped original, cover its edges with paper to block external light as you scan it.

Parent topic: [Solving Scanned Image Quality Problems](#)

Ripple Patterns Appear in an Image

You may see a ripple pattern (called a moiré) in scanned images of printed documents. This is caused by interference from differing pitches in the scanner's screen and your original's halftone screen. To reduce this effect, adjust these Epson Scan 2 settings (if available) and try scanning again:

- Select the **Descreening** setting on the Advanced Settings tab.
- Select a lower **Resolution** setting.
- Place the original at a slightly different angle.

Parent topic: [Solving Scanned Image Quality Problems](#)

Scanned Image Edges are Cropped

If the edges of a scanned image are cropped, make sure your original is placed correctly for scanning. If necessary, move your original away from the edges of the scanner glass slightly.

Parent topic: [Solving Scanned Image Quality Problems](#)

Related tasks

[Placing Originals on the Scanner Glass](#)

Solving Faxing Problems

Check these solutions if you have problems faxing with your product.

[Cannot Send or Receive Faxes](#)

[Cannot Receive Faxes with a Telephone Connected to Your Product](#)

[Fax Memory Full Error Appears](#)

[Fax Quality is Poor](#)

[Sent Fax is Received in an Incorrect Size](#)

[Received Fax is Not Printed](#)

Parent topic: [Solving Problems](#)

Cannot Send or Receive Faxes

If you cannot send or receive faxes, try these solutions:

- If an error code is displayed on the control panel, try the solutions suggested in the error code list.
- Use **Check Fax Connection** on the control panel (**Settings > General Settings > Fax Settings > Check Fax Connection**) to run the automatic fax connection check. Try the solutions suggested in the report.
- Make sure the recipient's fax machine is turned on and working.
- Make sure paper is loaded correctly in your product.
- Make sure you have set up your header information and have not blocked your caller ID. Otherwise, your faxes might be rejected by the recipient's fax machine.
- Check that the cable connecting your telephone wall jack to your product's **LINE** port is secure.
- Print a fax connection report using your product control panel or fax software to help diagnose the problem.
- Verify that the telephone wall jack works by connecting a phone to it and testing it.
- If you connected your product to a DSL phone line, you must connect a DSL filter to the phone jack to enable faxing over the line. Contact your DSL provider for the necessary filter.
- If your telephone line uses call waiting and you have trouble receiving faxes, turn off call waiting to prevent disruption of incoming faxes.
- If you have subscribed to a call forwarding service, the product may not be able to receive faxes. Contact your service provider for assistance.

Note: If your product is connected to a VoIP (Voice over Internet Protocol) phone line, keep in mind that fax machines are designed to work over analog phone lines. Epson cannot guarantee that fax transmission will work when using VoIP.

If your phone line includes voice mail answering services, calls or faxes may be inadvertently received by your voice mail service.

Parent topic: [Solving Faxing Problems](#)

Related references

[Job Status Error Codes](#)

Related tasks

[Loading Paper in the Cassettes and Paper Tray](#)

Related topics

[Setting Up Basic Fax Features](#)

Cannot Receive Faxes with a Telephone Connected to Your Product

If you cannot receive faxes when a telephone is connected to your product, try these solutions:

- Make sure your telephone is connected to your product's **EXT** port.
- Make sure the Receive Mode is set to **Manual**.

Note: When answering a call that is a fax, wait until the product's LCD screen displays a message that a connection has been made before you hang up.

Parent topic: [Solving Faxing Problems](#)

Fax Memory Full Error Appears

If you see an error message telling you that the product's fax memory is full, try these solutions:

- If you set the product to save received faxes in the product's memory or inbox, delete any faxes you have already read.
- If you set the product to save received faxes on a computer, turn on the selected computer. Once the faxes are saved on the computer, they are deleted from the product's memory.
- If the memory is full, try the following:
 - Send a monochrome fax using the direct sending feature
 - Send your faxes in smaller batches
- If the product cannot print a received fax due to a product error, such as a paper jam, the memory full error may appear. Clear any product errors, then ask the sender to resend the fax.

Parent topic: [Solving Faxing Problems](#)

Fax Quality is Poor

If you receive a poor quality fax, try these solutions:

- Try enabling the error correction mode (ECM) setting.
- Contact the fax sender and ask them to send the fax in a higher resolution.
- Try reprinting the received fax.

If the sent fax quality is poor, try these solutions:

- Clean the scanner glass.
- Clean the ADF.
- Try changing the resolution or density setting on the control panel.
- If you are sending a monochrome fax to a single recipient, try sending the fax using the **Direct Send** feature.

Note: If you send a high-resolution monochrome fax without using the **Direct Send** feature, the product may automatically lower the resolution.

- Try enabling the error correction mode (ECM) setting.

Parent topic: [Solving Faxing Problems](#)

Sent Fax is Received in an Incorrect Size

If your recipient receives a fax in an incorrect size, try these solutions:

- If you are sending a fax using the scanner glass, make sure your original is placed correctly and that the correct paper size is selected on the control panel.
- Clean the scanner glass and document cover.

Parent topic: [Solving Faxing Problems](#)

Received Fax is Not Printed

If a received fax is not printed, try these solutions:

- Make sure the product is free of errors. The product cannot print received faxes if an error has occurred with the product, such as a paper jam.

Parent topic: [Solving Faxing Problems](#)

Solving USB Device Problems

Check these solutions if you have problems using USB devices with your product.

[Cannot View or Print from a USB Device](#)

[Cannot Save Files on a USB Device](#)

[Cannot Transfer Files To or From a USB Device](#)

Parent topic: [Solving Problems](#)

Cannot View or Print from a USB Device

If you cannot view or print photos or documents from a USB device connected to your product, try these solutions:

- Make sure memory devices are enabled on the product.
- Make sure your device is compatible with the product.
- Make sure the files on your device are in the correct format.

Parent topic: [Solving USB Device Problems](#)

Cannot Save Files on a USB Device

If you cannot save files on a USB device connected to your product, try these solutions:

- Make sure the device is not write-protected.
- Make sure the device has enough available space.
- Make sure memory devices are enabled on your product.
- Make sure the device is compatible with the product.

Parent topic: [Solving USB Device Problems](#)

Cannot Transfer Files To or From a USB Device

If you have problems transferring files to or from a USB device connected to your product, try these solutions:

- Make sure your device is compatible with the product.
- Make sure your product is securely connected to your computer.
- Make sure that the file sharing setting for your product is enabled.

Parent topic: [Solving USB Device Problems](#)

Uninstall Your Product Software

If you have a problem that requires you to uninstall and re-install your software, follow the instructions for your operating system.



[Uninstalling Product Software - Windows](#)

[Uninstalling Product Software - Mac](#)

Parent topic: [Solving Problems](#)

Uninstalling Product Software - Windows

You can uninstall and then re-install your product software to solve certain problems.

1. Turn off the product.
2. Close any open programs or applications.
3. Disconnect any interface cables.
4. Do one of the following:
 - **Windows 11:** Click , then search for **Settings** and select it. Select **Apps** or **System > Apps & features**. Then select the program you want to uninstall and select **Uninstall**.
 - **Windows 10:** Click  and select  (Settings) > **Apps** or **System > Apps & features**. Then select the program you want to uninstall and select **Uninstall**.
 - **Windows 8.x:** Navigate to the **Apps** screen and select **Control Panel > Programs > Programs and Features**. Select the uninstall option for your Epson product, then select **Uninstall/Change**.

Note: If you see a **User Account Control** window, click **Yes** or **Continue**.

Select your product again, if necessary, then select **OK**, and click **Yes** to confirm the uninstallation.

- **Windows (other versions):** Click  or **Start**, and select **All Programs** or **Programs**. Select **EPSON**, select your product, then click **EPSON Printer Software Uninstall**.

Note: If you see a **User Account Control** window, click **Yes** or **Continue**.

In the next window, select your product and click **OK**. Then follow any on-screen instructions.

5. Do one of the following to uninstall Epson Scan 2, then follow any on-screen instructions:
 - **Windows 11/Windows 10:** Select **Epson Scan 2** and click **Uninstall**.
 - **Windows 8.x/Windows 7/Windows Vista:** Select **Epson Scan 2** and click **Uninstall/Change**.
 - **Windows 8.x/Windows 7:** Select **Epson Scan 2** and click **Uninstall/Change**.

Note: If you find that re-installing your product software does not solve a problem, contact Epson.

Parent topic: [Uninstall Your Product Software](#)

Uninstalling Product Software - Mac

In most cases, you do not need to uninstall your product software before re-installing it. However, you can download the Uninstaller utility from the Epson support website to uninstall your product software as described here.

Note: If you find that re-installing your product software does not solve a problem, contact Epson.

1. To download the Uninstaller utility, visit and select your product.
2. Click **Downloads**.
3. Select your operating system, click **Utilities**, locate the Uninstaller utility, and click **Download**.
4. Run the file you downloaded.
5. Double-click the **Uninstaller** icon.
6. In the Epson Uninstaller screen, select the checkbox for each software program you want to uninstall.
7. Click **Uninstall**.
8. Follow the on-screen instructions to uninstall the software.
9. Reinstall your product software.

Note: If you uninstall the printer driver and your product name remains in the **Print & Fax**, **Print & Scan**, or **Printers & Scanners** window, select your product name and click the – (remove) icon to remove it.

Parent topic: [Uninstall Your Product Software](#)

Where to Get Help (U.S. and Canada)

If you need to contact Epson for technical support services, use the following support options.

Internet Support

Visit Epson's support website at epson.com/support (U.S.), epson.ca/support (Canada), or latin.epson.com/support (Latin America) and select your product for solutions to common problems. You can download drivers and documentation, get FAQs and troubleshooting advice, or e-mail Epson with your questions.

Speak to a Support Representative

Before you call Epson for support, please have the following information ready:

- Product name
- Product serial number (located on a label on the product)
- Proof of purchase (such as a store receipt) and date of purchase
- Computer configuration
- Description of the problem

Then call: (866) 212-8743, 7 a.m. to 4 p.m., Pacific Time, Monday through Friday.

Days and hours of support are subject to change without notice. Toll or long distance charges may apply.

Purchase Supplies and Accessories

You can purchase genuine Epson ink and paper at epson.com (U.S. sales), epson.ca (Canadian sales), or latin.epson.com (Latin American sales). You can also purchase supplies from an Epson authorized reseller. To find the nearest one, call 800-GO-EPSON (800-463-7766) in the U.S. or 800-807-7766 in Canada.

Parent topic: [Solving Problems](#)

Where to Get Help (Latin America)

If you need additional help with your Epson product, contact Epson.

Epson provides these technical support services:

Internet Support

Visit Epson's support website at latin.epson.com/support for solutions to common problems. You can download drivers and documentation, get FAQs and troubleshooting advice, or e-mail Epson with your questions.

Speak to a Support Representative

Before you call Epson for support, please have the following information ready:

- Product name
- Product serial number (located on a label on the product)
- Proof of purchase (such as a store receipt) and date of purchase

- Computer configuration
- Description of the problem

Then call:

Country	Telephone
Argentina	(54 11) 5167-0300 0800-288-37766
Bolivia*	800-100-116
Brazil	0800-007-5000
Chile	(56 2) 2484-3400
Colombia	Bogota: (57 1) 602-4751 Other cities: 01-8000-915235
Costa Rica	800-377-6627
Dominican Republic*	1-888-760-0068
Ecuador*	1-800-000-044
El Salvador*	800-6570
Guatemala*	1-800-835-0358
Mexico	Mexico City: (52 55) 1323-2052 Other cities: 800-087-1080
Nicaragua*	00-1-800-226-0368
Panama*	00-800-052-1376
Paraguay	009-800-521-0019
Peru	Lima: (51 1) 418-0210 Other cities: 0800-10126
Uruguay	00040-5210067
Venezuela	(58 212) 240-1111

* Contact your local phone company to call this toll-free number from a mobile phone.

If your country does not appear in the list, contact the sales office in the nearest country. Toll or long distance charges may apply.

Purchase Supplies and Accessories

Parent topic: [Solving Problems](#)

Administering Your Product

Follow the instructions in these sections to configure your product's administrator settings using the Web Config software.

Note: Before you can configure system administration settings, you must connect the product to a network.

[Accessing the Web Config Utility](#)

[Changing the Administrator Password in Web Config](#)

[Configuring Product Settings](#)

[Configuring Security Settings](#)

[Using Your Product on a Secure Network](#)

[Setting Up Universal Print \(Microsoft\)](#)

[Using Epson Device Admin Configuration Software](#)

Accessing the Web Config Utility

You can select your product's network settings and confirm its operating status using a web browser. You do this by accessing your product's built-in Web Config utility from a computer or other device that is connected to the same network as your product.

1. Print a network status sheet.
2. Locate the IP address for your product that is listed on the network status sheet.
3. On a computer or other device connected to the same network as your product, open a web browser.
4. Enter your product's IP address into the address bar.
5. On the first visit to the Web Config utility, you will be prompted to set an administrator password. The administrator password is required to access the full capabilities of the Web Config utility.

You see the available Web Config utility options.

Parent topic: [Administering Your Product](#)

Changing the Administrator Password in Web Config

You can set an administrator password using your product's control panel, Web Config, or EpsonNet Config. You use the same administrator password in all cases.

Note: If you forget your administrator password, contact Epson for support.

1. Access Web Config as an administrator and select the **Product Security** tab.
2. Select **Change Administrator Password**.
3. Enter a user name, if necessary.
4. Do one of the following:
 - If you have set an administrator password before, enter the current password, then enter and confirm the new password in the fields provided.
 - If you have not set an administrator password before, enter a new password and confirm it in the fields provided.
5. Click **OK**.

Note: To restore the administrator password to the default value, select **Restore Default Settings** on the **Change Administrator Password** screen.

Parent topic: [Administering Your Product](#)

Configuring Product Settings

Follow the instructions in these sections to configure your product's control panel settings using the Web Config software.

[Checking Status Information](#)

[Managing the Network Connection](#)

[Setting Control Panel Options](#)

[Locking Individual Settings](#)

[Using an Email Server](#)

[Using an LDAP Server](#)

[Adjusting Power Saving Settings](#)

[Adjusting Control Panel Sounds](#)

[Erasing Hard Drive Data](#)

[Importing and Exporting Product Settings](#)

[Updating Firmware Using Web Config](#)

[Synchronizing the Date and Time with a Time Server](#)

[Clearing the Internal Memory](#)

[Adjusting the Contact List View Options](#)
[Powering Off or Rebooting the Product Remotely](#)
[Restoring Default Product Settings](#)
[Adjusting the Control Panel Layout](#)

Parent topic: [Administering Your Product](#)

Checking Status Information

You can check information about the printer using the Web Config interface.

Note: Depending on the features of your product, not all of the options below may be available. Some options are not available unless you are logged in to the Web Config interface.

1. Enter the IP address of the printer to access Web Config and log in as an administrator, if necessary.
2. Select the **Status** tab and choose one of the following options:
 - Select **Product Status** to view information such as ink level and maintenance box status.
 - Select **Network Status** to view network information such as the IP address and network connection status.
 - Select **Usage Status** to view information about the number of prints and historical information about the product.
 - Select **Hardware Status** to view information about the product functions.
 - Select **Job History** to view information about the jobs completed on the product.
 - Select **Panel Snapshot** to view a image of the current LCD screen.

Parent topic: [Configuring Product Settings](#)

Managing the Network Connection

You can check or update the network information for your product using the Web Config interface.

1. Enter the IP address of the product in a web browser and log in as an administrator.
2. Select the **Network** tab, then select **Basic**.
3. Check or update the settings as necessary.
4. Select **Next** to see a summary of the network settings.

5. Select **OK** to accept the changes.

Note: The network connection will be temporarily interrupted to enable the new settings.

6. Select the other network options as necessary:

- **Wi-Fi:** Displays the current wireless network connection information. Select **Setup** to run the wireless setup again or **Disable Wi-Fi** to turn off Wi-Fi.
- **Wired LAN:** Displays the current settings for the wired connection. Change the settings as necessary and then select **Next** to view the changes. Confirm the information and select **OK** to apply the changes.
- **Wi-Fi Direct:** Displays the current settings for the Wi-Fi Direct network. Adjust the settings as necessary and select **Next** to view the changes. Confirm the information and select **OK** to apply the changes.

[Network Settings](#)

Parent topic: [Configuring Product Settings](#)

Network Settings

The following network settings are available under the **Network** tab in the Web Config interface.

Basic

Setting	Description
Device Name	Displays the Device Name. You can enter a new name to change the name of the device.
Location	Displays a user-entered location for the printer
Obtain IP Address	Sets the IP Address; if set to Manual , enter the information in the appropriate fields
Set using BOOTP	Enables IP addressing using BOOTP
Set using Automatic Private IP Addressing (APIPA)	Enables IP addressing using APIPA
IP Address	Displays the IP address. If you are manually entering the IP address, enter it in the format xxx.xxx.xxx.xxx (where xxx is a number between 0 and 255). Make sure the address is unique and does not conflict with any other device on your network.

Setting	Description
Subnet Mask	Displays the subnet mask. If you are manually entering the subnet mask, enter it in the format xxx.xxx.xxx.xxx (where xxx is a number between 0 and 255).
Default Gateway	Displays the default gateway address. If you are manually setting the default gateway, enter it in the format xxx.xxx.xxx.xxx (where xxx is a number between 0 and 255).
DNS Server Setting	Selects the DNS server setting. If the Obtain IP Address setting is set to Manual , this setting is also set to Manual .
Primary DNS Server	Enter the address of the primary DNS server in the format xxx.xxx.xxx.xxx (where xxx is a number between 0 and 255).
Secondary DNS Server	Enter the address of the secondary DNS server in the format xxx.xxx.xxx.xxx (where xxx is a number between 0 and 255).
DNS Host Name Setting	Sets the DNS Host Name selection method.
DNS Host Name	Displays the current DNS Host Name.
DNS Domain Name Setting	Sets the DNS Domain Name selection method
DNS Domain Name	Specifies the DNS domain name. The name must conform to the following format: <ul style="list-style-type: none"> • Enter between 2 and 249 characters using only the characters "A-Z", "a-z", "0-9", hyphen "-", and a period "." • The first character cannot be a "0-9", hyphen "-", or a period "." • The last character cannot be a hyphen "-" or a period "." • Each label in the domain name must be between 1 and 63 characters and separated by a period. • The total number of characters in the host and domain name must not exceed 251.
Register the network interface address to DNS	Allows you to register the host and domain names through a DHCP server that supports Dynamic DNS
Proxy Server Setting	Enables the use of a proxy server
Proxy Server	Specifies the name of the proxy server in either IPv4 or FQDN format

Setting	Description
Proxy Server Port Number	Specifies the port number for the proxy server (between 1 and 65535)
Proxy Server User Name	Specifies the user name for the proxy server (0-255 ASCII characters [0x20-0x7E])
Proxy Server Password	Specifies the password for the proxy server (0-255 ASCII characters [0x20-0x7E])
IPv6 Setting	Enables the use of IPv6 addressing
IPv6 Privacy Extension	Enables the use of private IPv6 addresses
IPv6 DHCP Server Setting	Enables the use of a IPv6 DHCP server
IPv6 Address	<p>Specifies the IPv6 address. The address must conform to the following format:</p> <ul style="list-style-type: none"> • xxxx: xxxx: xxxx: xxxx: xxxx: xxxx: xxxx / prefix • xxxx is a hexadecimal number from 1 to 4 digits, and the prefix is a decimal number from 1 to 128. • If there are consecutive blocks where xxxx is all zeros, it can be omitted as ::. (Only one block can be omitted.)
IPv6 Address Default Gateway	<p>Specifies the IPv6 address of the default gateway. The address must conform to the following format:</p> <ul style="list-style-type: none"> • xxxx: xxxx: xxxx: xxxx: xxxx: xxxx: xxxx: xxxx • xxxx is a hexadecimal number from 1 to 4 digits • If there are consecutive blocks where xxxx is all zeros, it can be omitted as ::. (Only one block can be omitted.)
IPv6 Link-Local Address	Displays the valid IPv6 Link-Local Address
IPv6 Stateful Address	Displays the valid IPv6 Stateful Address
IPv6 Stateless Address 1	Displays the valid IPv6 Stateless Address 1
IPv6 Stateless Address 2	Displays the valid IPv6 Stateless Address 2
IPv6 Stateless Address 3	Displays the valid IPv6 Stateless Address 3

Setting	Description
IPv6 Primary DNS Server	Specifies the address for the IPv6 primary DNS server. The address must conform to the following format: <ul style="list-style-type: none"> • xxxx: xxxx: xxxx: xxxx: xxxx: xxxx: xxxx: xxxx • xxxx is a hexadecimal number from 1 to 4 digits • If there are consecutive blocks where xxxx is all zeros, it can be omitted as ::. (Only one block can be omitted)
IPv6 Secondary DNS Server	Specifies the address for the IPv6 secondary DNS server. The address must conform to the following format: <ul style="list-style-type: none"> • xxxx: xxxx: xxxx: xxxx: xxxx: xxxx: xxxx: xxxx • xxxx is a hexadecimal number from 1 to 4 digits • If there are consecutive blocks where xxxx is all zeros, it can be omitted as ::. (Only one block can be omitted.)
IEEE802.11k/v	Enables the use of IEEE802.11k/v network environments
IEEE802.11r	Enables the use of IEEE802.11r network environments

Wired LAN

Setting	Description
Link Speed and Duplex	Selects the communication mode for the wired connection
IEEE 802.3az	Enables the use of IEEE 802.3az network environments

Wi-Fi Direct

Setting	Description
Wi-Fi Direct	Enables the product's Wi-Fi Direct network
SSID	You can change part of the SSID for the product.
Password	Specifies the password for the Wi-Fi Direct network. Note: Changing the password will disconnect any devices currently connected to the network.

Setting	Description
Frequency Range	Selects the frequency range used by the Wi-Fi Direct network.
IP Address	Specifies the IP address for the Wi-Fi Direct network. If set to Manual , enter the IP address in the provided fields.

Parent topic: [Managing the Network Connection](#)

Setting Control Panel Options

You can configure the behavior of the product control panel using the Web Config interface or the menus on the control panel.

1. Enter the IP address of the product in a web browser and log into Web Config as an administrator.
2. Select **Device Management > Control Panel** and set the following items as necessary:
 - **Language:** Sets the display language
 - **Panel Lock:** Requires an administrator login to access some menu settings on the control panel. The administrator password must be set to enable this feature.
 - **Operation Timeout:** Cancels operations and automatically logs out users after a selected time period. You can select a time period between 10 seconds and 240 minutes.
 - **Theme Color:** Sets the color scheme for the control panel. Select a theme from the list.
 - **Display during printing:** Select an item to display on the LCD screen during printing. If you select Custom(Message), enter a message of up to 400 characters to display while printing. If you select Custom(Image), register or delete the images you want to display during printing.

Parent topic: [Configuring Product Settings](#)

Locking Individual Settings

If you use the Panel Lock or Lock Setting features to restrict access to certain settings, you can allow individual settings to be changed without administrative access.

1. On the product control panel, select **Settings > General Settings > System Administration > Security Settings > Restrictions**.
2. For each setting, allow access without logging in as an administrator by selecting **On**.
 - **Job Log Access:** Allows users to view the status monitor's job history.
 - **Access to Register/Delete Contacts:** Allows users to register, edit, or delete contacts.

- **Fax Recent Access:** Allows users to view recent fax destinations when sending a fax.
- **Fax Transmission Log Access:** Allows users to view the communication history of a fax.
- **Access to Fax Report:** Allows users to print the fax report.
- **Access to Print Save History of Scan to Network Folder/FTP:** Allows users to print a report of previous scans saved to a network folder.
- **Access to Recent of Scan to Email:** Allows users to display a list of recent scan to email activity.
- **Access to Show Sent History of Scan to Email:** Allows users to print a list of scan to email activity.
- **Access to Print Save History of Scan to Email Folder/FTP:** Allows users to print a report of previous scan to email activity.
- **Access to Language:** Allows users to change the display language.
- **Access to Thick Paper:** Allows users to change the thick paper settings.
- **Access to Quiet Mode:** Allows users to enable or disable Quiet Mode.
- **Access to Print Speed Priority:** Allows users to change the print speed priority settings.
- **Protection of Personal Data:** Hides the destination folder path when saving data to a location.
- **Access to Copy Output Tray:** Allows users to change the location where copies are output. This setting is only available when the staple finisher is installed.
- **Accept Power Off:** Allows users to turn the printer off using the power button.

Parent topic: [Configuring Product Settings](#)

Using an Email Server

Follow the instructions in these sections to use an email server to send scan and fax data by email, or use email notification using Web Config.

[Configuring an Email Server](#)

[Email Server Settings](#)

[Checking the Email Server Connection](#)

[Sending Email Notifications](#)

Parent topic: [Configuring Product Settings](#)

Configuring an Email Server

You can configure an email server using Web Config.

1. Access Web Config and select the **Network** tab.

2. Select **Email Server > Basic**.
3. Select the email server settings.
4. Click **OK**.

Parent topic: [Using an Email Server](#)

Email Server Settings

You can configure these email server settings in Web Config.

Setting	Options/Description
Authentication Method	Select the authentication method that matches your email server
Authenticated Account	Enter the authenticated account name from 1 to 255 characters long in ASCII
Authenticated Password	Enter the authenticated password from 1 to 20 characters long in ASCII using A-Z, a-z, 0-9, and these characters: ! # \$ % ' * + - . / = ? ^ _ { ! } ~ @
Sender's Email Address	Enter the sender's email address from 1 to 255 characters long in ASCII; do not use a period (.) as the first character or use these characters: () < > [] ;
SMTP Server Address	Enter the SMTP server address from 1 to 255 characters long using A-Z, a-z, 0-9, and "-" in IPv4 or FQDN format
SMTP Server Port Number	Enter the SMTP server port number between 1 and 65535
Secure Connection	Select the security method for the email server; available choices depend on the Authentication Method setting
Certificate Validation	Enable checking for a valid certificate; recommended value is Enable
POP3 Server Address	Enter the POP server address from 1 to 255 characters long using A-Z, a-z, 0-9, and "-" in IPv4 or FQDN format
POP3 Server Port Number	Enter the POP server port number between 1 and 65535

Parent topic: [Using an Email Server](#)

Checking the Email Server Connection

You can test the email server connection and view a connection report using Web Config.

1. Access Web Config and select the **Network** tab.
2. Select **Email Server > Connection Test**.
3. Click **Start**.

Web Config tests the connection and displays the connection report when it is finished.

Parent topic: [Using an Email Server](#)

Sending Email Notifications

You can set up email notifications that will be sent when an event occurs on the product. You can register up to five destinations.

Note: You must have configured a mail server before setting up notifications.

1. Enter the IP address of the product in a web browser and log into Web Config as an administrator.
2. Select the **Device Management** tab, then select **Email Notification**.
3. Set the contents of the email subject line by selecting items from the drop-down menus.

Note: You cannot select the same item in both menus. If the Location setting is longer than 32 bytes, it will be truncated in the Subject line.

4. Enter up to five email addresses to receive the notification emails, and select the language of the notification email.
5. In the Notification Settings area, select one or more email addresses to receive a notification for each event.
6. Click **OK** to apply the settings.

Note: To clear the email notification settings, select **Restore Default Settings**. This clears all email notification settings, not just the changes made in the current session.

Parent topic: [Using an Email Server](#)

Using an LDAP Server

Follow the instructions in these sections to use an LDAP server to provide fax and email destination information using Web Config.

[Configuring the LDAP Server and Selecting Search Settings](#)

[LDAP Server Settings](#)

[LDAP Search Settings](#)

[LDAP Connection Report Messages](#)

Parent topic: [Configuring Product Settings](#)

Configuring the LDAP Server and Selecting Search Settings

You can configure the LDAP server and select search settings for it using Web Config.

1. Access Web Config as an administrator and select the **Network** tab.
2. Select **LDAP Server** and select **Basic**.
3. Select the LDAP server settings.
4. Click **OK**.
5. Select **Search Settings**.
6. Select the LDAP search settings you want to use.
7. Click **OK**.

Note: To check the connection to the LDAP server, select **LDAP Server > Connection Check** and select **Start**.

Parent topic: [Using an LDAP Server](#)

LDAP Server Settings

You can configure these LDAP server settings in Web Config.

Setting	Options/Description
LDAP Server Address	Enter the address of the LDAP server as necessary, depending on the format of the server: <ul style="list-style-type: none">• IPv4 or IPv6 format: Enter from 1 to 255 characters• FQDN format: Enter from 1 to 255 alphanumeric characters in ASCII; you can use "-", except at the beginning or end of the address
LDAP server Port Number	Enter an LDAP server port number between 1 and 65535
Secure Connection	Select the encryption method for connecting to the LDAP server

Setting	Options/Description
Certificate Validation	Select Enable to validate the certificate when connecting to the LDAP server
Search Timeout (sec)	Enter a search time interval before timeout from between 5 and 300 seconds
Authentication Method	Select one of the available authentication methods listed
Kerberos Realm to be Used	If you selected Kerberos Authentication as the Authentication Method option, select the correct realm of Kerberos authentication from the realms defined under the Kerberos Settings menu entry.
Administrator DN/User Name	Leave this blank or enter a user name for the LDAP server from 0 to 128 characters long in Unicode (UTF-8); do not use control characters such as 0x00-0x1F or OX7F (not available when you selected Anonymous Authentication as the Authentication Method option)
Password	Leave this blank or enter a password from 1 to 128 characters long in Unicode (UTF-8) for LDAP server authentication; do not use control characters such as 0x00-0x1F or OX7F (not available when you selected Anonymous Authentication as the Authentication Method option)
Kerberos Settings	
Realm (Domain)	If you selected Kerberos Authentication as the Authentication Method option, enter the realm of Kerberos authentication from 0 to 255 characters long in ASCII; you can define up to 10 realms with associated addresses and port numbers
KDC Address	Leave this blank or, if you selected Kerberos Authentication as the Authentication Method option, enter the Kerberos server address from 0 to 255 characters long in IPv4, IPv6, or FQDN format
Port Number (Kerberos)	Leave this blank or, if you selected Kerberos Authentication as the Authentication Method option, enter the Kerberos server port number between 1 and 65535

Parent topic: [Using an LDAP Server](#)

LDAP Search Settings

You can configure these LDAP search settings in Web Config.

Setting	Options/Description
Search Base (Distinguished Name)	Leave blank or search for an arbitrary domain name on the LDAP server using 1 to 128 characters Unicode (UTF-8)
Number of search entries	Specify the maximum number of search entries before an error message appears, from 1 to 500
User name Attribute	Enter the attribute name to display when searching for users names from 1 to 255 characters long in Unicode (UTF-8); the first character must be a-z, or A-Z
User name Display Attribute	Leave blank or enter the attribute name to display as the user name from 1 to 255 characters long in Unicode (UTF-8); the first character must be a-z, or A-Z
Fax Number Attribute	Enter the attribute name to display when searching for fax numbers from 1 to 255 characters long using A-Z, a-z, 0-9, and "-" in Unicode (UTF-8); the first character must be a-z, or A-Z
Email Address Attribute	Leave blank or enter the attribute name to display when searching for email addresses from 1 to 255 characters long in Unicode (UTF-8); the first character must be a-z, or A-Z
Arbitrary Attribute 1 through Arbitrary Attribute 4	Leave blank or specify other arbitrary attributes to search for from 1 to 255 characters long in Unicode (UTF-8); the first character must be a-z, or A-Z

Parent topic: [Using an LDAP Server](#)

LDAP Connection Report Messages

You can review the connection report messages to diagnose LDAP connection problems in Web Config.

Message	Description
Connection test was successful.	Connection to the server is successful

Message	Description
Connection test failed. Check the settings.	One of the following occurred: <ul style="list-style-type: none"> • The LDAP server address or port number is incorrect • A timeout occurred • You selected Do Not Use as the Use LDAP Server setting • If you selected Kerberos Authentication as the Authentication Method setting, the Kerberos server settings are incorrect
Connection test failed. Check the date and time on your printer or server.	Connection failed because the time settings for the product and the LDAP server do not match
Authentication failed. Check the settings.	Authentication failed because the User Name and Password settings are incorrect or, if you selected Kerberos Authentication as the Authentication Method setting, the time and date are not configured correctly
Cannot access the printer until processing is complete.	The product is busy

Parent topic: [Using an LDAP Server](#)

Adjusting Power Saving Settings

The product can automatically enter sleep mode or turn off after it has not been used for a while. You can set the delay before the product enters sleep mode or turns off.

1. Log in to the Web Config interface as an administrator.
2. Select the **Device Management** tab, then select the **Power Saving** setting.
3. Set **Sleep Timer** to the number of minutes before the product enters a low-power mode.
4. Select **Power Off Timer** to set the amount to time of inactivity before the product turns off.

Note: If you are using a printer with the fax feature enabled, select **None**.

Note: You can also configure the power saving settings using the control panel by selecting **Settings > General Settings > Basic Settings** and selecting the feature you want to change.

Note: You can also configure the power saving settings using the control panel by selecting **Settings > General Settings > Basic Settings** and selecting the feature you want to change.

Note: You can also configure the power saving settings using the control panel by selecting **Settings > General Settings > Basic Settings** and selecting the feature you want to change.

Parent topic: [Configuring Product Settings](#)

Adjusting Control Panel Sounds

You can adjust the sound level heard when you press buttons on the control panel.

1. Log in to the Web Config interface as an administrator.
2. Select the **Device Management** tab, then select the **Sound** setting.
3. Select volume and sound settings as necessary for **Normal Mode** and **Quiet Mode**. You can also create different sound settings for fax operations.

Note: You can also configure the sound settings using the control panel by selecting **Settings > General Settings > Basic Settings > Sounds**.

Parent topic: [Configuring Product Settings](#)

Erasing Hard Drive Data

You can create settings to erase the contents of the internal hard drive (HDD). The product uses the hard drive to store printing, copying, and scanning data including authenticated print jobs. You can enable sequential deletion, which erases data when it is no longer needed after scanning or printing is completed; or you can format the hard drive to erase all data.

Note: When formatting the hard drive, you can choose from the following options:

- **High Speed:** Erases all data with a dedicated erase command
- **Overwrite:** Erase all data and then overwrites all areas with data
- **Triple Overwrite:** Erases all data and then overwrites all areas with data three times

1. Determine the method you want to use to erase data from the hard drive.
2. Depending on your choice, do one of the following:
 - To enable sequential deletion, log into Web Config as an administrator, then select **Device Management > Stored Data > Sequential Deletion from Hard Disk** and set it to **On**.

- To format the hard drive, select **Settings > General Settings > System Administration > HDD Erase Settings > Erase All Memory**. Select the method of formatting the drive.

Parent topic: [Configuring Product Settings](#)

Importing and Exporting Product Settings

Follow the instructions in these sections to import and export your product's settings using the Web Config software.

[Exporting Settings Using Web Config](#)

[Importing Settings Using Web Config](#)

Parent topic: [Configuring Product Settings](#)

Exporting Settings Using Web Config

You can export your product's settings and optionally encrypt the settings file with a password.

1. Log in to the Web Config interface as an administrator.
2. Select the **Device Management** tab, then select **Export** under **Export and Import Setting Value**.
3. Select the settings you want to export.

Note: If you select a parent category, the child categories are also selected. By default, items that are unique on the network, such as IP address, cannot be selected. If you want to export these items, select **Enable to select the individual settings of device**. It is recommended that you export only unique items when replacing a product on the network, otherwise you may encounter conflicts on the network.

4. Enter an encryption password, if desired.
5. Click **Export** and save the file.

Parent topic: [Importing and Exporting Product Settings](#)

Importing Settings Using Web Config

You can import settings to your product that you have exported previously. If encryption was used when the settings were exported, obtain the necessary password before you import.

1. Log in to the Web Config interface as an administrator.
2. Select the **Device Management** tab, then select **Import** under **Export and Import Setting Value**.
3. Click **Browse** and select the exported settings file.
4. If necessary, enter the decryption password.

5. Click **Next**.
6. Select the settings to import and click **Next**.
7. Click **OK**.

The selected settings are imported to the product.

Parent topic: [Importing and Exporting Product Settings](#)

Updating Firmware Using Web Config

If your product is connected to the Internet, you can update the product firmware using Web Config.

1. Access Web Config and select **Device Management > Firmware Update**.
2. Click **Start** to check for the latest firmware.
3. If there is a firmware update, click **Start** to begin the update.

Note: Make sure the product is not in use and clear any errors on the LCD screen before starting the update. You can also schedule a firmware update by selecting **Automatic Firmware Update** from the menu.

Parent topic: [Configuring Product Settings](#)

Synchronizing the Date and Time with a Time Server

You can synchronize the product with an NTP time server to set the date and time on the product.

Note: If you are using a CA certificate or Kerberos authentication, it is recommended to use a time server to set the date and time.

1. Log in to the Web Config interface as an administrator.
2. Select the **Device Management** tab, then select the **Date and Time > Time Server** setting.
3. Set **Use Time Server** to **Use**.
4. Enter the time server address in **Time Server Address**. You can use the IPv4, IPv6, or FQDN format for the address. You are limited to 252 characters.
5. Enter an update interval (up to 10080 minutes) in **Update Interval (min)**.
6. Click **OK** to update the settings.

Parent topic: [Configuring Product Settings](#)

Clearing the Internal Memory

You can delete the contents of the product's internal memory, such as password-protected print jobs and downloaded PCL fonts and macros using the Web Config interface. You cannot select individual items to delete.

1. Log in to the Web Config interface as an administrator.
2. Select the **Device Management** tab, then select the **Clear Internal Memory Data** setting.
3. Select **Delete** and confirm your selection.

Parent topic: [Configuring Product Settings](#)

Adjusting the Contact List View Options

You can adjust the way contacts are listed on the product's LCD screen. You can also configure the way searches are performed when searching the contact list.

1. Log in to the Web Config interface as an administrator.
2. Select the **Device Management** tab, then select the **Contacts Manager** setting.
3. Select either **Tile View** or **List View** to control how the contacts are displayed on the product's LCD screen.
4. Select an search option from the **Search Options** drop-down list.
5. Select **OK** to apply your changes.

Parent topic: [Configuring Product Settings](#)

Powering Off or Rebooting the Product Remotely

You can power off or reboot the product using the Web Config interface.

1. Log in to the Web Config interface as an administrator.
2. Select the **Device Management** tab, then select the **Power** setting.
3. Select a power option from the drop down menu and select **Execute**.

Note: After turning off the product, you cannot access Web Config until the product is turned on again.

Parent topic: [Configuring Product Settings](#)

Restoring Default Product Settings

You can reset the product to the default settings using the Web Config interface.

1. Log in to the Web Config interface as an administrator.
2. Select the **Device Management** tab, then select the **Restore Default Settings** setting.
3. Select an option from the drop-down list. You can either restore network settings or all data and settings.
4. Select **Execute** and confirm your selection to restore the product settings.

Parent topic: [Configuring Product Settings](#)

Adjusting the Control Panel Layout

You can edit the layout and icons displayed on the home screen.

1. Log in to the Web Config interface as an administrator.
2. Select the **Device Management** tab, then select the **Edit Home** setting.
3. Select **Layout** and then select the icons and their position. The pagination of the home screen varies depending on the selections.

Note: If you have registered any presets, you can select them to be displayed on the home screen.

Parent topic: [Configuring Product Settings](#)

Configuring Security Settings

Follow the instructions in these sections to configure internal security features for your product using the Web Config software.

[Connecting an Authentication Device](#)

[Restricting Features Available for Users](#)

[Disabling the External Interface](#)

[Setting Up Password Encryption](#)

[Working with Audit Logs](#)

[Setting a Password Policy](#)

[Restricting Application Access](#)

[Restricting PDL File Operations](#)

[Enabling Program Verification on Start Up](#)

[Restricting Domain Access](#)

Parent topic: [Administering Your Product](#)

Connecting an Authentication Device

You can connect an authentication device such as an IC card reader using a USB cable, and check the functionality of the reader using the Web Config interface.

1. Connect the card reader's USB cable to the service port on the product.
2. Access Web Config and log in using the administrator name and password.
3. Select **Device Management > Card Reader**.
4. Set the card reader parameters as necessary.
5. Select **Check** to verify the connection status of the authentication device.

Note: To confirm that the authentication device can recognize an authentication card, hold the card over the reader while you select **Check**.

6. Click **Next**.
7. Click **OK** to confirm the settings.

Parent topic: [Configuring Security Settings](#)

Restricting Features Available for Users

Follow the instructions in these sections to restrict users from using certain product features and create an administrator password to lock the restrictions using the Web Config software.

[User Feature Restriction](#)

[Configuring User Feature Restrictions](#)

Parent topic: [Configuring Security Settings](#)

User Feature Restriction

You can restrict available product features for individual users, with different features available to each user. This requires users to log into the product control panel with their user name and password before they can use control panel features.

With Windows, you can also restrict printing and scanning from the product software. This requires users to log into the printing or scanning software, and allows the software to authenticate the users before printing or scanning proceeds. For instructions on setting up software restrictions, see the help utility in the printing or scanning software.

Parent topic: [Restricting Features Available for Users](#)

Configuring User Feature Restrictions

You can create up to 10 user accounts and restrict access to control panel features separately for each one.

Note: If you are using an authentication system, it uses the number one user account. If you create other user accounts, use the number two to number 10 user accounts.

1. Access Web Config and select the **Product Security** tab.
2. Select the **Enables Access Control** checkbox.
3. If you have configured the product for an LDAP server, you can deselect the **Allows printing and scanning without authentication information from a computer** checkbox to prevent the product from receiving jobs sent from these sources:
 - The default operating system driver
 - A PCL or PostScript printer driver
 - Web services such as Epson Connect
 - Smartphones and other mobile devices
4. Click **OK**.
5. Select **User Settings**.
6. Click **Add**.
7. Enter a name for a user in the User Name field following the guidelines on the screen. Use ASCII (0x20-0x7E) characters.
8. Enter a password for the user in the Password field following the guidelines on the screen.

Note: If you need to reset a password, leave the password field blank.

9. Select the checkbox for each function you want the user to be able to perform, and deselect the checkbox for each function you want to restrict access to.
10. Click **Apply**.

Note: When you edit a completed user account, you see a **Delete** option. Click it to delete a user, if necessary.

Note: You can import and export a list of user features using EpsonNet Config. See the help utility in the software for instructions.

Parent topic: [Restricting Features Available for Users](#)

Disabling the External Interface

You can restrict the ability to connect from a computer using a USB connection or accessing a connected USB device or memory card.

Note: Depending on your product features, not all of the options listed below may be available.

1. Access Web Config and select **Product Security > External Interface**.
2. Select **Memory Device** and do one of the following:
 - Select **Disable** to prevent access to a USB device or memory card.
 - Select **Enable** to allow access to a USB device or memory card.
3. Click **OK** to save your setting.

Parent topic: [Configuring Security Settings](#)

Setting Up Password Encryption

You can set up password encryption to protect confidential information stored in the product. You can also back up the encryption key that is stored in your product's Trusted Platform Module (TPM) chip to a USB flash drive.

Note: Make sure you have a USB flash drive with at least 1MB of storage space to back up the encryption key.

Caution: If the TPM chip fails, you cannot replace it or access any confidential information stored on your product. Printer functions are still available, but the password encryption feature cannot be used. Contact Epson for support.

1. Press the  home button, if necessary.
2. Select **Settings > General Settings > System Administration > Security Settings**.
3. Select **Password Encryption**.
4. Select **Password Encryption** again.
5. Select **On**.
A message appears about restarting the product. Select **OK**.
6. Select **Proceed to Backup**.

You see the encryption key backup screen.

7. Insert your USB flash drive into the external USB port on the front of the product.
8. Select **Start Backup**.

The product begins backing up the encryption key to the USB flash drive. Any previously stored encryption key is overwritten.

9. When the backup completion message appears, select **Close**.
10. Turn the product off and then on again to apply the password encryption setting.

Note: The product may take longer than usual to turn on. This is normal.

[Restoring the Password Encryption Key](#)

Parent topic: [Configuring Security Settings](#)

Restoring the Password Encryption Key

If the TPM chip fails, you can restore the encryption key from its backup stored on your USB flash drive.

1. If you see a message on the control panel that the TPM has been replaced when you turn on the product, select **Restore from Backup**. Enter the administrator password, if necessary.
2. Insert your USB flash drive containing the stored encryption key into the external USB port on the front of the product.
3. Select **Restore from Backup**.
The stored encryption key is restored to the TPM chip.
4. When the completion message appears, select **OK**.

The product restarts.

Parent topic: [Setting Up Password Encryption](#)

Working with Audit Logs

You can enable the Audit Log feature or export audit log data using the Web Config interface. Audit logs can be used to track security issues or identify improper usage.

1. Log in to the Web Config interface as an administrator.
2. Select the **Product Security** tab, then select the **Audit Log** setting.
3. Select **ON** to enable the audit log feature.
4. Select **Export** to export the audit log data to a CSV file, or select **Delete** to delete all audit logs.

Parent topic: [Configuring Security Settings](#)

Setting a Password Policy

You can increase the strength of user passwords by setting constraints on password length and content through a password policy.

1. Log in to the Web Config interface as an administrator.
2. Select the **Product Security** tab, then select the **Password Policy** setting.
3. Set the **Password Policy** setting to **Enable**, then set the following settings:
 - **Minimum Password Length**: Sets the minimum number of characters for the password.
 - **Include Uppercase Alphabet**: When enabled, the password must include one or more uppercase characters.
 - **Include Lowercase Alphabet**: When enabled, the password must include one or more lowercase characters.
 - **Include Number**: When enabled, the password must include one or more numbers.
 - **Include Punctuation Mark**: The password must include one or more punctuation marks.
4. Select **OK** to save your settings.

Parent topic: [Configuring Security Settings](#)

Restricting Application Access

You can restrict applications from accessing the printer using the Web Config interface.

1. Log in to the Web Config interface as an administrator.
2. Select the **Product Security** tab, then select the **Application** setting.
3. If you do not want an application to access the printer, clear the checkbox next to the application name. The list of applications depends on the printer model.

Parent topic: [Configuring Security Settings](#)

Restricting PDL File Operations

You can protect files from unauthorized PDL operations using the Web Config interface.

1. Log in to the Web Config interface as an administrator.
2. Select the **Product Security** tab, then select the **File Operations from PDL** setting.

3. Select **Allowed** or **Not Allowed** to enable or disable PDL file operations and select **OK** to apply your setting.

Parent topic: [Configuring Security Settings](#)

Enabling Program Verification on Start Up

Your product automatically checks whether unauthorized third parties have tampered with the program when the product starts up. If it detects that the product has been rewritten with invalid firmware, it will stop and update the firmware.

If you enable **Do not start if tampering is detected**, the printer will display an error and stop booting. It is not recommended to enable the **Do not start if tampering is detected** setting as the default setting.

1. Log in to the Web Config interface as an administrator.
2. Select the **Product Security** tab, then select **Program Verification on Start Up**.
3. Enable the **Do not start if tampering is detected** setting.

Parent topic: [Configuring Security Settings](#)

Restricting Domain Access

You can set up restrictions on the email domains that can be used for email notifications using the Web Config interface.

1. Log in to the Web Config interface as an administrator.
2. Select the **Product Security** tab, then select the **Domain Restrictions** setting.
3. Select a restriction method for the **Restriction Rule** setting. Select **Allow Sending** to limit sending emails to the listed domains or select **Deny Sending** to prevent emails from being sent to the listed domains.
4. Add the necessary domains to the list by entering them in the **Domain Name** field and selecting **Add**.
The domain is added to the list. To delete domain, select the checkbox next to the domain name and select **Delete**.

5. Select **OK** to apply your changes.

Parent topic: [Configuring Security Settings](#)

Using Your Product on a Secure Network

Follow the instructions in these sections to configure security features for your product on the network using the Web Config software.

[Configuring Protocols and Services in Web Config](#)
[Configuring SSL/TLS Communication](#)
[Configuring IPsec/IP Filtering](#)
[Connecting the Product to an IEEE 802.1X Network](#)
[Configuring S/MIME Settings](#)
[Using a Digital Certificate](#)

Parent topic: [Administering Your Product](#)

Configuring Protocols and Services in Web Config

You can enable or disable protocols using Web Config.

1. Access Web Config as an administrator, select **Network Security**, and select **Protocol**.
2. Select or deselect the checkbox next to the service name to enable or disable a protocol.
3. Configure any other available protocol settings.
4. Click **Next**.
5. Click **OK**.
6. Select and configure services and protocol settings as necessary.

After the protocols restart, the changes are applied.

[Protocol Settings](#)

Parent topic: [Using Your Product on a Secure Network](#)

Protocol Settings

Protocols

Name	Description
Bonjour	Bonjour is used to search for devices and AirPrint
SLP	SLP is used for push-scanning and network searching in EpsonNet Config
WSD	Add WSD devices, or print and scan from the WSD port
LLTD	Displays the product on the Windows network map
LLMNR	Use name resolution without NetBIOS even if you cannot use DNS

Name	Description
LPR	Print from to the LPR port
RAW(Port9100)	Print from the RAW port (Port 9100)
RAW(Custom Port)	Print from the RAW port (custom port)
IPP	Print over the Internet, including AirPrint
FTP	Print over FTP
SNMPv1/v2c	Remotely set up and monitor your product
SNMPv3	Remotely set up and monitor your product with the SNMPv3 protocol

Bonjour Settings

Setting	Options/Description
Use Bonjour	Search for or use devices through Bonjour (you cannot use AirPrint if disabled)
Bonjour Name	Displays the Bonjour name
Bonjour Service Name	Displays the Bonjour service name
Location	Displays the Bonjour location name
Top Priority Protocol	Selects the protocol that is the top priority for Bonjour printing
Wide-Area Bonjour	Enables the Wide-Area Bonjour protocol; register all products on the DNS server to locate them over the segment

SLP Settings

Setting	Options/Description
Enable SLP	Enable the SLP function to use the Push Scan function and network searching in EpsonNet Config

WSD Settings

Setting	Options/Description
Enable WSD	Enable adding devices using WSD, and printing and scanning from the WSD port
Printing Timeout (sec)	Enter the communication timeout value for WSD printing between 3 and 3,600 seconds
Scanning Timeout (sec)	Enter the communication timeout value for WSD scanning between 3 and 3,600 seconds
Device Name	Displays the WSD device name
Location	Displays the WSD location name

LLTD Settings

Setting	Options/Description
Enable LLTD	Enable LLTD to display the product in the Windows network map
Device Name	Displays the LLTD device name

LLMNR Settings

Setting	Options/Description
Enable LLMNR	Enable LLMNR to use name resolution without NetBIOS, even if you cannot use DNS

LPR Settings

Setting	Options/Description
Allow LPR Port Printing	Allow printing from the LPR port
Printing Timeout (sec)	Enter the timeout value for LPR printing between 0 and 3,600 seconds

RAW (Port9100) Settings

Setting	Options/Description
Allow RAW (Port9100) Printing	Allow printing from the RAW port (Port 9100)
Printing Timeout (sec)	Enter the timeout value for RAW port (Port 9100) printing between 0 and 3,600 seconds

RAW (Custom Port) Settings

Setting	Options/Description
Allow RAW (Custom Port) Printing	Allow printing from the RAW port (custom port)
Port Number	Enter the port number for RAW printing between 1024 and 65535 (except 9100, 1865, and 2968)
Printing Timeout (sec)	Enter the timeout value for RAW port (custom port) printing between 0 and 3,600 seconds

IPP Settings

Setting	Options/Description
Enable IPP	Enable IPP communication for products that support IPP are displayed (you cannot use AirPrint if disabled)
Allow Non-secure Communication	Allow the printer to communicate without any security measures (IPP)
Communication Timeout (sec)	Enter the timeout value for IPP printing between 0 and 3,600 seconds
Require PIN Code when using IPP printing	Select whether or not to require a PIN code when using IPP printing. If you select Yes , IPP print jobs without PIN codes are not saved in the product.
URL(Network)	Displays IPP URLs (http and https) when the product is connected using wired LAN or Wi-Fi (the URL is a combined value of the product's IP address, Port number, and IPP printer name)

Setting	Options/Description
URL(Wi-Fi Direct)	Displays IPP URLs (http and https) when the product is connected using Wi-Fi Direct (the URL is a combined value of the product's IP address, Port number, and IPP printer name)
Printer Name	Displays the IPP printer name
Location	Displays the IPP location

FTP Settings

Setting	Options/Description
Enable FTP Server	Enable FTP printing for products that support FTP printing
Communication Timeout (sec)	Enter the timeout value for FTP communication between 0 and 3,600 seconds

SNMPv1/v2c Settings

Setting	Options/Description
Enable SNMPv1/v2c	Enable SNMPv1/v2c for products that support SNMPv3
Access Authority	Set the access authority when SNMPv1/v2c is enabled to Read Only or Read/Write
Community Name (Read Only)	Enter 0 to 32 ASCII characters
Community Name (Read/Write)	Enter 0 to 32 ASCII characters
Allow access from Epson tools	Allow information to be written from Epson tools such as Epson Device Admin

SNMPv3 Settings

Setting	Options/Description
Enable SNMPv3	Enable SNMPv3 for products that support SNMPv3
User Name	Enter 1 to 32 characters
Authentication Settings	Select an algorithm and set a password for authentication
Encryption Settings	Select an algorithm and set a password for encryption

Setting	Options/Description
Context Name	Enter 1 to 32 characters in Unicode (UTF-8)

Parent topic: [Configuring Protocols and Services in Web Config](#)

Configuring SSL/TLS Communication

Follow the instructions in these sections to configure SSL/TLS communication using Web Config.

[Configuring SSL/TLS Settings](#)

[Configuring a Server Certificate for the Product](#)

Parent topic: [Using Your Product on a Secure Network](#)

Configuring SSL/TLS Settings

If your product supports HTTPS, you can configure SSL/TLS to encrypt communications with your product.

1. Access Web Config and select the **Network Security** tab.
2. Select **SSL/TLS > Basic**.
3. Select one of the options for the **Encryption Strength** setting.
4. Select **Enable** or **Disable** for the **Redirect HTTP to HTTPS** setting as necessary.
5. If necessary, enable a TLS version.
6. Click **Next**.
You see a confirmation message.
7. Click **OK**.

Parent topic: [Configuring SSL/TLS Communication](#)

Configuring a Server Certificate for the Product

You can configure a server certificate for your product.

1. Access Web Config and select the **Network Security** tab.
2. Under **SSL/TLS**, select **Certificate**.
3. Select one of the following options:
 - **CA-signed Certificate**: Select **Import** if you have obtained a CA-signed certificate. Choose the file to import and click **OK**.

- **Self-signed Certificate:** Select **Update** if you have not obtained a CA (Certificate Authority)-signed certificate and want the product to generate a self-signed certificate.
4. Click **Next**.
You see a confirmation message.
 5. Click **OK**.

Parent topic: [Configuring SSL/TLS Communication](#)

Configuring IPsec/IP Filtering

Follow the instructions in these sections to configure IPsec/IP traffic filtering using Web Config.

[About IPsec/IP Filtering](#)

[Configuring the Default IPsec/IP Filtering Policy](#)

[Configuring the Group IPsec/IP Filtering Policies](#)

[IPsec/IP Filtering Policy Settings](#)

[IPsec/IP Filtering Configuration Examples](#)

[Configuring an IPsec/IP Filtering Certificate](#)

Parent topic: [Using Your Product on a Secure Network](#)

About IPsec/IP Filtering

You can filter traffic to the product over the network based on IP address, service, and port by configuring a default policy that applies to every user or group connecting to the product. For control of individual users or user groups, you can configure group policies.

Note: IPsec is supported only by computers running Windows Vista or later, or Windows Server 2008 or later.

Parent topic: [Configuring IPsec/IP Filtering](#)

Configuring the Default IPsec/IP Filtering Policy

You can configure the default policy for IPsec/IP traffic filtering using Web Config.

1. Access Web Config and select the **Network Security** tab.
2. Under **IPsec/IP Filtering**, select **Basic**.
3. Select **Enable** to enable IPsec/IP filtering.
4. Select the filtering options you want to use for the default policy.
5. Click **Next**.

You see a confirmation message.

6. Click **OK**.

Parent topic: [Configuring IPsec/IP Filtering](#)

Configuring the Group IPsec/IP Filtering Policies

You can configure group policies for IPsec/IP traffic filtering using Web Config.

1. Access Web Config and select the **Network Security** tab.
2. Under **IPsec/IP Filtering**, select **Basic**.
3. Click a tab number for the policy number you want to configure.
4. Select the **Enable this Group Policy** checkbox.
5. Select the filtering options you want to use for this group policy.
6. Click **Next**.

You see a confirmation message.

7. Click **OK**.
8. If you want to configure additional group policies, click the next tab number and repeat the configuration steps as necessary.

Parent topic: [Configuring IPsec/IP Filtering](#)

IPsec/IP Filtering Policy Settings

Default Policy Settings

Setting	Options/Description
Access Control	Permit Access to permit IP packets to pass through Refuse Access to prevent IP packets from passing through IPsec to permit IPsec packets to pass through
IKE Version	Select the version of the Internet Key Exchange (IKE) protocol that matches your network environment
Authentication Method	Select an authentication method, or select Certificate if you have imported a CA-signed certificate
Pre-Shared Key	If necessary, enter a pre-shared key between 1 and 127 characters long

Setting	Options/Description
ID Type	If you selected IKEv2 as the IKE Version setting, select the ID type from the list.
ID	If you selected IKEv2 as the IKE Version setting, enter the necessary ID information
Encapsulation	If you selected IPsec as the Access Control option, select one of these encapsulation modes: Transport Mode: if you are using the product on the same LAN; IP packets of layer 4 or later are encrypted Tunnel Mode: if you are using the product on an Internet-capable network, such as IPsec-VPN; the header and data of IP packets are encrypted
Remote Gateway(Tunnel Mode)	If you selected Tunnel Mode as the Encapsulation option, enter a gateway address between 1 and 39 characters long
Security Protocol	If you selected IPsec as the Access Control option, select one of these security protocols: ESP: to ensure the integrity of authentication and data, and encrypt data AH: to ensure the integrity of authentication and data; if data encryption is prohibited, you can use IPsec
Algorithm Settings	Select the encryption algorithm settings for the security protocol you selected

Group Policy Settings

Setting	Options/Description
Access Control	Permit Access to permit IP packets to pass through Refuse Access to prevent IP packets from passing through IPsec to permit IPsec packets to pass through

Setting	Options/Description
Local Address(Printer)	Select an IPv4 or IPv6 address that matches your network environment; if the IP address is assigned automatically, select Use auto-obtained IPv4 address
Remote Address(Host)	Enter the device's IP address (between 0 and 43 characters long) to control access, or leave blank to control all addresses; if the IP address is assigned automatically, such as by DHCP, the connection may be unavailable, so configure a static address instead
Method of Choosing Port	Select the method you want to used for specifying ports
Service Name	If you selected Service Name as the Method of Choosing Port option, select a service name option here; see the next table for more information
Transport Protocol	If you selected Port Number as the Method of Choosing Port option, select one of these encapsulation modes: Any Protocol TCP UDP ICMPv4 See the Group Policy Guidelines table for more information.
Local Port	If you selected Port Number as the Method of Choosing Port option, and TCP or UDP for the Transport Protocol option, enter the port numbers that control receiving packets (up to 10 ports), separated by commas, for example 25,80,143,5220 ; leave this setting blank to control all ports; see the next table for more information
Remote Port	If you selected Port Number as the Method of Choosing Port option, and TCP or UDP for the Transport Protocol option, enter the port numbers that control sending packets (up to 10 ports), separated by commas, for example 25,80,143,5220 ; leave this setting blank to control all ports; see the next table for more information

Setting	Options/Description
IKE Version	Select IKEv1 or IKEv2 depending on the device that the product is connected to
Authentication Method	If you selected IPsec as the Access Control option, select an authentication method here
Pre-Shared Key	If you selected Pre-Shared Key as the Authentication Method option, enter a pre-shared key between 1 and 127 characters long here and in the Confirm Pre-Shared Key field
ID Type	If you selected IKEv2 as the IKE Version setting, select the ID type from the list
ID	If you selected IKEv2 as the IKE Version setting, enter the necessary ID information
Encapsulation	If you selected IPsec as the Access Control option, select one of these encapsulation modes: Transport Mode: if you are using the product on the same LAN; IP packets of layer 4 or later are encrypted Tunnel Mode: if you are using the product on an Internet-capable network, such as IPsec-VPN; the header and data of IP packets are encrypted
Remote Gateway(Tunnel Mode)	If you selected Tunnel Mode as the Encapsulation option, enter a gateway address between 1 and 39 characters long
Security Protocol	If you selected IPsec as the Access Control option, select one of these security protocols: ESP: to ensure the integrity of authentication and data, and encrypt data AH: to ensure the integrity of authentication and data; if data encryption is prohibited, you can use IPsec
Algorithm Settings	Select the encryption algorithm settings for the security protocol you selected

Combinations of Local Address (Printer) and Remote Address (Host) on Group Policy

Setting of Remote Address (Host)	Setting of Local Address (Printer)		
	IPv4	IPv6 ^{*2}	Any addresses ^{*3}
IPv6 ^{*1 *2}	—	Yes	Yes
Blank	Yes	Yes	Yes

*1: If you selected **IPsec** as the **Access Control** option, you cannot specify a prefix length

*2: If you selected **IPsec** as the **Access Control** option, you can select a link-local address (fe80::), but the group policy will be disabled.

*3: You cannot use IPv6 link-local addresses.

Group Policy Guidelines

Service name	Protocol type	Local/Remote port number	Controls these operations
ENPC	UDP	3289/Any port	Searching for a product from applications such as printer or scanner drivers, or EpsonNet Config
SNMP	UDP	161/Any port	Acquiring and configuring MIB from applications such as printer or scanner drivers, or EpsonNet Config
LPR	TCP	515/Any port	Forwarding LPR data
RAW (Port9100)	TCP	9100/any port	Forwarding RAW data
IPP/IPPS	TCP	631/Any port	Forwarding AirPrint data (IPP/IPPS printing)
WSD	TCP	Any port/5357	Controlling WSD
WS-Discovery	UDP	3702/Any port	Searching for a product from WSD
Network Scan	TCP	1865/Any port	Forwarding scan data from Document Capture Pro
Network Push Scan	TCP	Any port/2968	Acquiring job information on push scanning from Document Capture Pro

Service name	Protocol type	Local/Remote port number	Controls these operations
Network Push Scan Discovery	UDP	2968/Any port	Searching for a computer during push scanning from Document Capture Pro
FTP Data (Local)	TCP	20/Any port	Forwarding FTP printing data to FTP server
FTP Control (Local)	TCP	21/Any port	Controlling FTP printing to FTP server
FTP Data (Remote)	TCP	Any port/20	Forwarding scan data and received fax data to FTP client; controls only an FTP server that uses remote port 20
FTP Control (Remote)	TCP	Any port/21	Forwarding scan data and received fax data to FTP client
CIFS (Local)*	TCP	445/Any port	Sharing a network folder on CIFS server
CIFS (Remote)*	TCP	Any port/445	Forwarding scan data and received fax data to a folder on CIFS server
NetBIOS Name Service (Local)	UDP	137/Any port	Sharing a network folder on CIFS server
NetBIOS Datagram Service (Local)	UDP	138/Any port	
NetBIOS Session Service (Local)	TCP	139/Any port	
NetBIOS Name Service (Remote)	UDP	Any port/137	Forwarding scan data and received fax data to a folder on CIFS server
NetBIOS Datagram (Remote)	UDP	Any port/138	
NetBIOS Session Service (Remote)	TCP	Any port/139	
HTTP (Local)	TCP	80/Any port	Forwarding Web Config and WSD data to a HTTP or HTTPS server
HTTPS (Local)	TCP	443/Any port	

Service name	Protocol type	Local/Remote port number	Controls these operations
HTTP (Remote)	TCP	Any port/80	Communicating with Epson Connect, firmware update, and root certificate update on a HTTP or HTTPS client
HTTPS (Remote)	TCP	Any port/443	

* To control forwarding of scan and received fax data, share a network folder, or receive fax data from PC-Fax, select **Port Number** as the **Method of Choosing Port** option and specify the port numbers for CIFS and NetBIOS.

Parent topic: [Configuring IPsec/IP Filtering](#)

IPsec/IP Filtering Configuration Examples

You can configure IPsec and IP filtering in a variety of ways, as shown in the examples here.

Receiving IPsec Packets Only

Use this example only for configuring a default policy.

- **IPsec/IP Filtering:** Enable
- **Access Control:** IPsec
- **Authentication Method:** Pre-Shared Key
- **Pre-Shared Key:** Enter a key up to 127 characters long

Receiving Printing Data and Printer Settings

Use this example to allow communication of printing data and printer settings from specified services.

Default policy:

- **IPsec/IP Filtering:** Enable
- **Access Control:** Refuse Access

Group policy:

- **Access Control:** Permit Access
- **Remote Address(Host):** Client IP address
- **Method of Choosing Port:** Service Name
- **Service Name:** Select **ENPC**, **SNMP**, **HTTP (Local)**, **HTTPS (Local)**, and **RAW (Port9100)**

Receiving Access from Only a Specified Address for Product Access

In these examples, the client will be able to access and configure the product in any policy configuration.

Default policy:

- **IPsec/IP Filtering: Enable**
- **Access Control: Refuse Access**

Group policy:

- **Access Control: Permit Access**
- **Remote Address (Host):** Administrator's client IP address

Parent topic: [Configuring IPsec/IP Filtering](#)

Configuring an IPsec/IP Filtering Certificate

You can configure a certificate for IPsec/IP traffic filtering using Web Config.

1. Access Web Config and select the **Network Security** tab.
2. Under **IPsec/IP Filtering**, select **Client Certificate**.
3. Click **Import** to add a new client certificate and enter any necessary settings.
4. Click **OK**.

Parent topic: [Configuring IPsec/IP Filtering](#)

Connecting the Product to an IEEE 802.1X Network

Follow the instructions in these sections to connect the product to an IEEE 802.1X network using Web Config.

[Configuring an IEEE 802.1X Network](#)

[IEEE 802.1X Network Settings](#)

[Configuring a Certificate for an IEEE 802.1X Network](#)

[IEEE 802.1X Network Status](#)

Parent topic: [Using Your Product on a Secure Network](#)

Configuring an IEEE 802.1X Network

If your product supports IEEE 802.1X, you can use it on a network with authentication provided by a RADIUS server with a hub as an authenticator using Web Config.

1. Access Web Config and select the **Network Security** tab.
2. Under **IEEE802.1X**, select **Basic**.

3. Select **Enable** as the **IEEE802.1X (Wired LAN)** setting.
4. To use the product on a Wi-Fi network, enable your product's Wi-Fi settings. (This requires the optional Wi-Fi module to be installed.)

The status of the connection is shown as the **IEEE802.1X (Wi-Fi)** setting.

Note: You can share the network settings for Ethernet and Wi-Fi networking.

5. Select the IEEE 802.1X setting options you want to use.
6. Click **Next**.
You see a confirmation message.
7. Click **OK**.

Parent topic: [Connecting the Product to an IEEE 802.1X Network](#)

IEEE 802.1X Network Settings

You can configure these IEEE 802.1X network settings in Web Config.

Setting	Options/Description
IEEE802.1X (Wired LAN)	Enable or disable settings (IEEE802.1X > Basic)
IEEE802.1X (Wi-Fi)	Displays the IEEE802.1X (Wi-Fi) connection status
Connection Method	Displays the current network connection method
EAP Type	Select one of these authentication methods for connections between the product and a RADIUS server: EAP-TLS or PEAP-TLS : You must obtain and import a CA-signed certificate PEAP/MSCHAPv2 or EAP-TTLS : You must configure a password
User ID	Enter an ID between 1 and 128 ASCII characters for authentication on a RADIUS server
Password	Enter a password between 1 and 128 ASCII characters for authentication of the product. If you are using Windows as a RADIUS server, enter up to 127 ASCII characters.
Confirm Password	Enter the authentication password again

Setting	Options/Description
Server ID	Enter a server ID between 1 and 128 ASCII characters for authentication on a specified RADIUS server; server ID is verified in the subject/subjectAltName field of a server certificate sent from the RADIUS server
Certificate Validation (Wired LAN)	Select a valid certificate regardless of the authentication method; import the certificate using the CA Certificate option
Anonymous Name	If you selected EAP-TTLS , PEAP-TLS or PEAP/MSCHAPv2 as the Authentication Method setting, you can configure an anonymous name between 1 and 128 ASCII characters instead of a user ID for phase 1 of a PEAP authentication
Encryption Strength	Select one of the following encryption strengths: High for AES256/3DES Middle for AES256/3DES/AES128/RC4

Parent topic: [Connecting the Product to an IEEE 802.1X Network](#)

Configuring a Certificate for an IEEE 802.1X Network

If your product supports IEEE 802.1X, you can configure a certificate for the network using Web Config.

1. Access Web Config and select the **Network Security** tab.
2. Under **IEEE802.1X**, select **Client Certificate**.
3. Click **Import** to add a new client certificate.
4. Click **OK**.

Parent topic: [Connecting the Product to an IEEE 802.1X Network](#)

IEEE 802.1X Network Status

You can check the status of the IEEE 802.1X network settings by printing a status sheet from your product.

The network status sheet displays the information in this table for IEEE 802.1X networks.

Status ID	Status description
Disable	IEEE 802.1X is disabled

Status ID	Status description
EAP Success	IEEE 802.1X authentication is confirmed and the network connection is available
Authenticating	IEEE 802.1X authentication in progress
Config Error	Authentication failed because the user ID was not set
Client Certificate Error	Authentication failed because the client certificate is out of date
Timeout Error	Authentication failed because there is no answer from the RADIUS server and/or authenticator
User ID Error	Authentication failed because the product's user ID and/or certificate protocol is incorrect
Server ID Error	Authentication failed because the server ID on the server certificate and the server's ID do not match
Server Certificate Error	Authentication failed because the server certificate is out of date or the chain of the server certificate is incorrect
CA Certificate Error	Authentication failed because the CA certificate is incorrect, not imported, or out of date
EAP Failure	Authentication failed because the client certificate is incorrect (EAP-TLS or PEAP-TLS), or the user ID or password is incorrect (PEAP/MSCHAPv2)

Parent topic: [Connecting the Product to an IEEE 802.1X Network](#)

Configuring S/MIME Settings

Follow the instructions in these sections to configure S/MIME settings using Web Config.

[Configuring S/MIME Basic Settings](#)

[S/MIME Settings](#)

[Configuring a Certificate for S/MIME](#)

Parent topic: [Using Your Product on a Secure Network](#)

Configuring S/MIME Basic Settings

You can configure the email encryption and digital signature attachment to emails as necessary.

1. Access Web Config and select the **Network Security** tab.
2. Under **S/MIME**, select **Basic**.

3. Select a setting for each option.
4. Click **Next**.
You see a confirmation message.
5. Click **OK**.

Parent topic: [Configuring S/MIME Settings](#)

S/MIME Settings

Mail Encryption

You need to import an encryption certificate for each destination registered in the contacts list. Unencrypted emails are sent to destinations that do not have an imported encryption certificate.

Setting	Options/Description
Scan to Email	Select settings for scanning to email Encrypt: to configure email encryption Do not encrypt: scan to an email destination without encryption Select at runtime: decide whether or not to encrypt the email before you send it Default at runtime: select the default action when Select at runtime is selected
Box to Email	Select settings for uploading files to email Encrypt: configure email encryption Do not encrypt: upload a file to an email destination without encryption Select at runtime: decide whether or not to encrypt the email before you send it Default at runtime: select the default action when Select at runtime is selected
Fax to Email	Configure email encryption when sending a fax to email
Algorithm	Select the algorithm for email encryption

Digital Signature

You need to configure the client certificate to include a digital signature.

Setting	Options/Description
Scan to Email	Select settings for scanning to email Add signature: add a digital signature to emails Do not add signature: scan to an email destination without a digital signature Select at runtime: decide whether or not to add a digital signature to the email before you send it Default at runtime: select the default action when Select at runtime is selected
Box to Email	Select settings for uploading files to email Add signature: add a digital signature to emails Do not add signature: upload a file to an email destination without a digital signature Select at runtime: decide whether or not to add a digital signature to the email before you send it Default at runtime: select the default action when Select at runtime is selected
Fax to Email	Configure the digital signature when sending a fax to email
Algorithm	Select the algorithm for the digital signature

Parent topic: [Configuring S/MIME Settings](#)

Configuring a Certificate for S/MIME

You can configure a client certificate to use the S/MIME signature feature.

1. Access Web Config and select the **Network Security** tab.
2. Under **S/MIME**, select **Client Certificate**.
3. Select one of the following options:
 - **CA-signed Certificate:** Select **Import** if you have obtained a CA-signed certificate. Choose the file to import and click **OK**.

- **Self-signed Certificate:** Select **Update** if you have not obtained a CA (Certificate Authority)-signed certificate and want the product to generate a self-signed certificate.

You can use the self-signed certificate instead of a CA-signed certificate. You can use S/MIME functions without the cost of obtaining a CA-signed certificate, for example in a network environment that does not have an external connection (Internet connection), such as an enterprise network. However, it is recommended to use a CA-signed certificate when using external connections because a self-signed certificate is low-security.

4. Click **Next**.

You see a confirmation message.

5. Click **OK**.

Parent topic: [Configuring S/MIME Settings](#)

Using a Digital Certificate

Follow the instructions in these sections to configure and use digital certificates using Web Config.

[About Digital Certification](#)

[Obtaining and Importing a CA-signed Certificate](#)

[CSR Setup Settings](#)

[CSR Import Settings](#)

[Deleting a CA-signed Certificate](#)

[Updating a Self-signed Certificate](#)

[Importing a CA Certificate](#)

[Deleting a CA Certificate](#)

Parent topic: [Using Your Product on a Secure Network](#)

About Digital Certification

You can configure the following digital certificates for your network using Web Config:

CA-signed Certificate

You can ensure secure communications using a CA-signed certificate for each security feature. The certificates must be signed by and obtained from a CA (Certificate Authority).

Self-signed Certificate

A self-signed certificate is issued and signed by the product itself. You can use the certificate for only SSL/TLS communication, however security is unreliable and you may see a security alert in the browser during use.

Parent topic: [Using a Digital Certificate](#)

Obtaining and Importing a CA-signed Certificate

You can obtain a CA-signed certificate by creating a CSR (Certificate Signing Request) using Web Config and submitting it to a certificate authority. The CSR created in Web Config is in PEM/DER format. You can import one CSR created from Web Config at a time.

1. Access Web Config and select **Network Security**.
2. Select one of the available network security options and select a certificate option.
3. In the CSR section, select **Generate**.
4. Select the CSR setting options you want to use.
5. Click **OK**.

You see a completion message.

6. Select **Network Security**, select your network security option, and select **Certificate** again.
7. In the CSR section, click the **Download** option that matches the format specified by your certificate authority to download the CSR.

Caution: Do not generate another CSR or you may not be able to import a CA-signed certificate.

8. Submit the CSR to the certificate authority following the format guidelines provided by that authority.
9. Save the issued CA-signed certificate to a computer connected to the product.
Before proceeding, make sure the time and date settings are correct on your product.
10. Select **Network Security**, select your network security option, and select **Certificate** or **Client Certificate** as necessary.
11. In the CA Certificate section, click **Import**.
12. Select the format of the certificate as the **Server Certificate** setting.
13. Select the certificate import settings as necessary for the format and the source from which you obtained it.
14. Click **OK**.

You see a confirmation message.

15. Click **Confirm** to verify the certificate information.

Parent topic: [Using a Digital Certificate](#)

Related references

[CSR Setup Settings](#)

CSR Import Settings

CSR Setup Settings

You can select these settings when setting up a CSR in Web Config.

Note: The available key length and abbreviations vary by certificate authority, so follow the rules of that authority when entering information in the CSR.

Setting	Options/Description
Key Length	Select a key length for the CSR
Common Name	Enter a name or static IP address from 1 to 128 characters long; for example, Reception printer or https://10.152.12.225
Organization, Organizational Unit, Locality, State/Province	Enter information in each field as necessary, from 0 to 64 characters long in ASCII; separate any multiple names with commas
Country	Enter a two-digit country code number as specified by the ISO-3166 standard
Sender's Email Address	Enter the sender's email address for the mail server setting

Parent topic: [Using a Digital Certificate](#)

CSR Import Settings

You can configure these settings when importing a CSR in Web Config.

Note: The import setting requirements vary by certificate format and how you obtained the certificate.

Certificate format	Setting descriptions
PEM/DER format obtained from Web Config	Private Key: Do not configure because the product contains a private key Password: Do not configure CA Certificate 1/CA Certificate 2: Optional

Certificate format	Setting descriptions
PEM/DER format obtained from a computer	<p>Private Key: Configure a private key</p> <p>Password: Do not configure</p> <p>CA Certificate 1/CA Certificate 2: Optional</p>
PKCS#12 format obtained from a computer	<p>Private Key: Do not configure</p> <p>Password: Optional</p> <p>CA Certificate 1/CA Certificate 2: Do not configure</p>

CA-signed Certificate Import Settings

Setting	Description
Server Certificate or Client Certificate	<p>Select the certificate format.</p> <p>For an SSL/TLS connection, the Server Certificate is displayed.</p> <p>For an IPsec/IP Filtering, IEEE802.1x, or S/MIME connection, the Client Certificate is displayed.</p> <p>Note: Depending on your product, not all connection types may be available.</p>
Private Key	If you obtain a certificate of the PEM/DER format by using a CSR created from a computer, specify a private key file that matches the certificate.
Password	If the file format is Certificate with Private Key (PKCS#12) , enter the password for encrypting the private key that is set when you obtain the certificate.
CA Certificate 1	If your certificate's format is Certificate (PEM/DER) , import a certificate from a certificate authority that issues a CA-signed Certificate to be used as the server certificate. Specify a file if necessary.

Setting	Description
CA Certificate 2	If your certificate's format is Certificate (PEM/DER) , import a certificate from the same certificate authority that issued CA Certificate 1. Specify a file if necessary.

Parent topic: [Using a Digital Certificate](#)

Deleting a CA-signed Certificate

You can delete an imported CA-signed certificate with Web Config when the certificate expires or if you have no more need for an encrypted connection.

Note: If you obtained a CA-signed certificate from Web Config, you cannot import a deleted certificate; you must obtain and import a new certificate.

1. Access Web Config and select **Network Security**.
2. Select one of the following network security options and corresponding certificate:
 - **SSL/TLS** and select **Certificate**
 - **IPsec/IP Filtering** and select **Client Certificate**
 - **IEEE802.1X** and select **Client Certificate**
3. Click **Delete**.
You see a completion message.
4. Click **OK**.

Parent topic: [Using a Digital Certificate](#)

Updating a Self-signed Certificate

If your product supports the HTTPS server feature, you can update a self-signed certificate using Web Config.

1. Access Web Config and select **Network Security**, select **SSL/TLS**, and select **Certificate**.
2. Click **Update**.

3. Enter an identifier for your product from 1 to 128 characters long in the **Common Name** field.

Note: You can add up to 5 IPv4 addresses, IPv6 addresses, host names, or FQDNs; separated by commas. The first value is assigned to the Common Name field, and the rest are added to the Alias field of the certificate subject. You cannot enter a space before or after a comma.

4. Select a validity period for the certificate as the **Certificate Validity (year)** setting.
5. Click **Next**.
You see a completion message.
6. Click **OK**.
7. Click **Confirm** to verify the certificate information.

Parent topic: [Using a Digital Certificate](#)

Importing a CA Certificate

You can import a CA certificate using Web Config.

1. Access Web Config and select **Network Security**.
2. Select **CA Certificate**.
3. Select **Import**.
4. Select the CA certificate you want to import.
5. Click **OK**.

When you see the **CA Certificate** page and the imported certificate is displayed, the import is finished.

Parent topic: [Using a Digital Certificate](#)

Deleting a CA Certificate

You can delete an imported CA certificate with Web Config when the certificate expires or if you have no more need for an encrypted connection.

1. Access Web Config and select **Network Security Settings**.
2. Select **CA Certificate**.
3. Locate the certificate you want to remove and click the **Delete** button next to it.
4. Click **OK** to confirm the deletion.
5. Click **Reboot Network**, and then check that the deleted CA Certificate is not listed on the updated screen.

Parent topic: [Using a Digital Certificate](#)

Setting Up Universal Print (Microsoft)

You can set up your product for use with Universal Print if you are using Microsoft 365 and Azure Active Directory.

Note: This feature is supported on Windows 10 2004 (20H1) or later. Visit the Microsoft website for more information.

1. Access Web Config and select the **Network** tab.
2. Select **Universal Print**.
3. Select **Register**.
4. Follow the on-screen instructions to register your product.

Parent topic: [Administering Your Product](#)

Using Epson Device Admin Configuration Software

With Windows, you can discover and monitor remote devices, and configure network settings in a batch operation. See the Epson Device Admin help for instructions.

To install Epson Device Admin, download the software from the support page at epson.com/support (U.S.), epson.ca/support (Canada), or latin.epson.com/support (Latin America) and follow the on-screen instructions.

Parent topic: [Administering Your Product](#)

Technical Specifications

These sections list the technical specifications for your product.

Note: Epson offers a recycling program for end of life Epson products. Please go to [this site](#) (U.S.) or [this site](#) (Canada) for information on how to return your Epson products for proper disposal.

[Windows System Requirements](#)
[Mac System Requirements](#)
[Paper Specifications](#)
[Printable Area Specifications](#)
[Scanning Specifications](#)
[Automatic Document Feeder \(ADF\) Specifications](#)
[Fax Specifications](#)
[Ink Cartridge Specifications](#)
[Dimension Specifications](#)
[Electrical Specifications](#)
[Environmental Specifications](#)
[Interface Specifications](#)
[External USB Device Specifications](#)
[Storage Specifications](#)
[Network Interface Specifications \(U.S. and Canada\)](#)
[Network Interface Specifications \(Latin America\)](#)
[Safety and Approvals Specifications \(U.S. and Canada\)](#)
[Safety and Approvals Specifications \(Latin America\)](#)
[Staple Finisher Specifications](#)
[Inner Finisher Specifications](#)
[Super G3/G3 Multi Fax Board Specifications](#)
[10/100/1000 Base-T Ethernet Specifications](#)
[Inner Tray Specifications](#)
[High-Capacity Unit Specifications](#)
[Optional Dual Cassette Specifications](#)
[HDD Specifications](#)

Windows System Requirements

To use your product and its software, your computer should use one of these Microsoft operating systems:

- Windows 11
- Windows 10
- Windows 8.x
- Windows 7

Note: For the latest product software available for your operating system, visit the Epson support site at [epson.com/support](https://www.epson.com/support) (U.S.), [epson.ca/support](https://www.epson.ca/support) (Canada), or [latin.epson.com/support](https://www.latin.epson.com/support) (Latin America), select your product, and select **Downloads**.

Parent topic: [Technical Specifications](#)

Mac System Requirements

To use your product and its software, your Mac should use one of these operating systems:

- macOS 13.x
- macOS 12.x
- macOS 11.x
- macOS 10.15.x
- macOS 10.14.x
- macOS 10.13.x
- macOS 10.12.x
- OS X 10.11.x
- OS X 10.10.x
- OS X 10.9.x

Note: Mac OS may not support some applications and features; the UNIX File System (UFS) for Mac OS is not supported.

Note: For the latest product software available for your operating system, visit the Epson support site at epson.com/support (U.S.), epson.ca/support (Canada), or latin.epson.com/support (Latin America), select your product, and select **Downloads**.

Parent topic: [Technical Specifications](#)

Paper Specifications

Note: Since the quality of any particular brand or type of paper may be changed by the manufacturer at any time, Epson cannot guarantee the quality of any non-Epson brand or type of paper. Always test a sample of paper stock before purchasing large quantities or printing large jobs.

Single-sheets

Size

12 × 18 inches (305 × 457 mm)
A3 (11.7 × 16.5 inches [297 × 420 mm])
A4 (8.3 × 11.7 inches [210 × 297 mm])
A5 (5.8 × 8.2 inches [148 × 210 mm])
A6 (4.1 × 5.8 inches [105 × 148 mm])
Executive (7.25 × 10.5 inches [184 × 267 mm])
Half Letter (5.5 × 8.5 inches [140 × 216 mm])
Letter (8.5 × 11 inches [216 × 279 mm])
Legal (8.5 × 14 inches [216 × 356 mm])
8.5 × 13 inches (216 × 330 mm)
11 × 17 inches (279 × 432 mm)
B4 (13.9 × 9.84 inches [353 × 250 mm])
B5 (7.2 × 10.1 inches [182 × 257 mm])
B6 (5 × 7.2 inches [128 × 182 mm])
Oficio 9 (8.46 × 12.4 inches [215 × 315 mm])
Mexico-Oficio (8.5 × 13.4 inches [216 × 340 mm])

Paper types

Plain paper and thick paper

Note: Your product also supports compatible papers distributed by Epson. See the link at the end of this topic for a list of compatible Epson papers.

Weight

Plain paper: 16 lb (60 g/m²) to 24 lb (90 g/m²)

Thick paper: 24 lb (91 g/m²) to 66 lb (250 g/m²)

Extra-thick paper: 67 lb (251 g/m²) to 80 lb (300 g/m²)

Envelopes

Size

No. 10 (4.1 × 9.5 inches [105 × 241 mm])

Paper types

Plain bond paper

Weight

20 lb (75 g/m²) to 27 lb (100 g/m²)

Parent topic: [Technical Specifications](#)

Printable Area Specifications

Single sheets

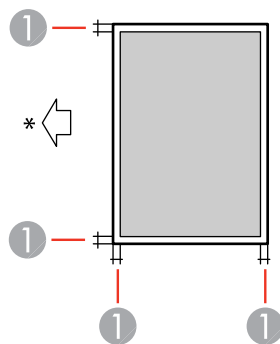

1 Margin: 0.12 inch (3 mm)

* Direction paper is fed

Envelopes

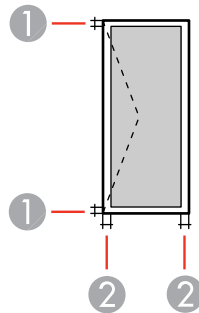

- 1 Left/right margin: 0.12 inch (3 mm)
- 2 Top/bottom margin: 0.12 inch (3 mm)

Parent topic: [Technical Specifications](#)

Scanning Specifications

Scanner type	Flatbed
Photoelectric device	CIS
Effective pixels	7020 × 10200 pixels at 600 dpi
Maximum scan area	11.7 × 17 inches (297 × 431.8 mm)
Maximum document size	A3 (11.7 × 16.5 inches [297 × 420 mm]) 11 × 17 inches (279 × 432 mm)
Scanning resolution	600 dpi (main scan) 600 dpi (sub scan)
Output resolution	50 to 9600 dpi in 1 dpi increments

Image data	<p>Color:</p> <p>30 bits per pixel internal (10 bits per pixel per color internal)</p> <p>24 bits per pixel external (8 bits per pixel per color external)</p> <p>Grayscale:</p> <p>10 bits per pixel internal</p> <p>8 bits per pixel external</p> <p>Black and white:</p> <p>10 bits per pixel internal</p> <p>1 bit per pixel external</p>
Light source	LED

Parent topic: [Technical Specifications](#)

Automatic Document Feeder (ADF) Specifications

Paper size	A6 (4.1 × 5.8 inches [105 × 148 mm]) to A3 (11.7 × 16.5 inches [297 × 420 mm])/11 × 17 inches (279 × 432 mm) (Maximum 11.7 × 17 inches [297 × 431.8 mm])
Paper type	Plain paper, high quality paper, recycled paper
Paper weight	14 lb (52 g/m ²) to 35 lb (128 g/m ²)
Sheet feeding capacity	Total thickness: 0.65 inch (16.5 mm) Approximately 150 sheets at 22 lb (80 g/m ²)

Note: Depending on the quality of the paper, originals that meet the ADF specifications still may not feed or scan correctly.

Caution: Do not load the following types of originals in the ADF, or they may be damaged or may damage the scanner. Use the scanner glass for these types:

- Photos or valuable original artwork
- Thermal paper
- Originals containing staples or paper clips

- Originals with carbon paper backing
- Originals that are bound
- Originals with labels, stickers, or sticky notes
- Originals that are ripped, curled, folded, deteriorated, or wrinkled
- Originals with holes
- Originals that are irregularly cut or shaped
- Originals that have not dried or cooled from printing

Parent topic: [Technical Specifications](#)

Fax Specifications

Specifications only applicable to models with optional fax board installed.

Fax type	Walk-up black-and-white and color fax capability (ITU-T Super Group 3)
Support line	Standard analog telephone lines PBX (Private Branch Exchange) telephone systems
Speed	Up to 33.6 kbps
Resolution	<p>Monochrome</p> <p>Standard: 203 pixels per inch × 98 lines per inch (8 pixels per mm × 3.85 lines per mm)</p> <p>Fine: 203 pixels per inch × 196 lines per inch (8 pixels per mm × 7.7 lines per mm)</p> <p>Super Fine: 203 pixels per inch × 392 lines per inch (8 pixels per mm × 15.4 lines per mm)</p> <p>Ultra Fine: 406 pixels per inch × 392 lines per inch (16 pixels per mm × 15.4 lines per mm)</p> <p>Color</p> <p>200 × 200 dpi</p>
Page memory	Up to 550 pages (ITU-T No. 1 chart; monochrome draft mode)
Redial	2 times (with 1 minute interval)

Interface	RJ-11 Phone Line RJ-11 Telephone set connection
------------------	--

Parent topic: [Technical Specifications](#)

Ink Cartridge Specifications

Note: We recommend that you use genuine Epson maintenance boxes and cartridges and do not refill them. The use of other products may affect your print quality and could result in printer damage.

Part of the ink from the included set of cartridges is used for charging the printer. Yields vary considerably based on images printed, print settings, paper type, frequency of use, and temperature. For print quality, a variable amount of ink remains in the cartridge after the "replace cartridge" indicator comes on.

Color	Cyan, Magenta, Yellow, Black
Ink cartridge life	Unopened package: do not use if the date on the package has expired
Temperature	Storage: -4 to 104 °F (-20 to 40 °C) 1 month at 104 °F (40 °C) Ink may freeze if it is stored below 0°C (32°F) Ink thaws and is usable after approximately 3 hours at 77 °F (25 °C)

Parent topic: [Technical Specifications](#)

Dimension Specifications

All dimensions are for the main unit only.

Storage:

Height	37.9 inches (963 mm)
Width	21.9 inches (555 mm)
Depth	24.4 inches (620 mm)

Printing:

Height	37.9 inches (963 mm)
Width	36.5 inches (926 mm)
Depth	26.8 inches (680 mm)

All covers, trays, cassettes, and the ADF open:

Height	52.6 inches (1336 mm)
Width	41.9 inches (1065 mm)
Depth	48.7 inches (1238 mm)

Weight (without consumables) Approx. 219.2 lb (99.4 kg)

Parent topic: [Technical Specifications](#)

Electrical Specifications

Power supply rating	100 to 240 V
Rated frequency range	50/60 Hz
Rated current	4.0 to 2.0 A
Power consumption (with LAN connection)	Standalone copying: Approx. 115 W (ISO/IEC24712) Ready mode: 46 W Sleep mode: 0.9 W Power off mode: 0.1 W Maximum power consumption: 190 W
Typical Energy Consumption (TEC)*	AM-C6000: 0.25 AM-C5000: 0.22 AM-C4000: 0.21

* TEC is an abbreviation of Typical Electricity Consumption and is the power consumption (kWh) for a standard week (5 days of repeated operation and sleep/off and two days of sleep/off). This value is used as a reference value to comply with the "International Energy Star Program".

Parent topic: [Technical Specifications](#)

Environmental Specifications

Temperature	Operating: 50 to 95 °F (10 to 35 °C) Storage: –4 to 104 °F (–20 to 40 °C) 1 month at 104 °F (40 °C)
Humidity (without condensation)	Operating: 15 to 85% RH Storage: 5 to 85% RH

Parent topic: [Technical Specifications](#)

Interface Specifications

Interface type	SuperSpeed USB (Device Class for computers) Hi-Speed USB (for external USB devices)
-----------------------	--

Note: Epson cannot guarantee the operation of externally connected devices.

Parent topic: [Technical Specifications](#)

External USB Device Specifications

Do not use devices with the following requirements:

- Dedicated driver
- Security settings

Note: Use only external storage devices with independent AC power sources. External storage devices that are powered via USB are not recommended. Epson cannot guarantee the operation of externally connected devices.

USB flash drive	2TB (formatted in FAT, FAT32, or exFAT)
------------------------	---

You can use USB devices with your product containing files that meet these specifications.

File format	JPEG with the Exif version 2.31 standard taken by digital cameras with the DCF (Design Rule for Camera File system) version 1.0 or 2.0 standard ¹ TIFF 6.0-compliant uncompressed images: RGB full-color or binary (not CCITT-encoded) PDF version 1.7 compliant data
Image size	80 × 80 pixels to 10200 × 10200 pixels
File size	Up to 2GB
Number of files	JPEG: Up to 9990 ² TIFF: Up to 999 PDF: Up to 999

¹ Files stored on digital cameras with built-in memory are not supported.

² If the number of files exceeds 999, the files are displayed in groups.

Parent topic: [Technical Specifications](#)

Storage Specifications

Storage capacity	90 GB
Number of folders	Shared Folder: 1 Shared folders: 0 to 199 Personal folders: Unlimited
Maximum number of files in a folder	3,000 files
Maximum pages of files saved in a folder	15,000 pages
Maximum number of saved jobs*	Printing: 100 Sending by email, saving in the folder, or cloud service: 10

*: The number of jobs that can be executed before the first job finishes.

Note: You may not be able to save new files after the memory usage rate reaches 100%. When the memory usage rate is less than 100%, and the number of files saved or number of pages saved in the folder reaches the limit, you may not be able to save the entire job. Delete as many unnecessary files as possible.

Parent topic: [Technical Specifications](#)

Network Interface Specifications (U.S. and Canada)

Wi-Fi

(Only available with optional Wireless LAN interface)

Standard	IEEE802.11a/b/g/n/ac; IEEE802.11n available only on the 20 MHz channel
Frequency ranges	IEEE802.11a/n/ac: 5 GHz IEEE802.11b/g/n: 2.4 GHz
Wi-Fi channels	5 GHz*: W52 (36/40/44/48) W53 (52/56/60/64) W56 (100/104/108/112/116/120/124/128/132/136/140/144) W58 (149/153/157/161/165) 2.4 GHz: 1/2/3/4/5/6/7/8/9/10/11
Wi-Fi Direct channels	5 GHz*: W52 (36/40/44/48) W58 (149/153/157/161/165) 2.4 GHz: 1/2/3/4/5/6/7/8/9/10/11
Maximum radio-frequency power transmitted	20 dBm (EIRP)

Connection modes

Infrastructure mode
 Wi-Fi Direct (Simple AP)

Note: Wi-Fi Direct (Simple AP) mode not available for IEEE 802.11b.

Wireless security protocols

WEP (64/128 bit)
 WPA2-PSK (AES); complies with WPA2 standards with support for WPA/WPA2 Personal
 WPA3-SAE (AES)
 WPA2/WPA3-Enterprise

Note: Wi-Fi Direct supports only WPA2-PSK (AES).

*The availability of outdoor use over these channels varies by location, as described in the table below.

Limitations for Using 5GHz Frequencies Outdoors

Frequency range	W52	W53	W56	W58
Frequency	5150-5250 MHz	5250-5350 MHz	5470-5725 MHz	5725-5850 MHz
Channel	36/40/44/48	52/56/60/64	100/104/108/112/116/ 120/124/128/132/136/140	149/153/157/161/ 165
U.S.	Outdoor use allowed	Outdoor use allowed	Outdoor use allowed	Outdoor use allowed
Canada	Outdoor use prohibited	Outdoor use allowed	Outdoor use allowed	Outdoor use allowed

Ethernet

Standards	IEEE802.3i (10BASE-T) IEEE802.3u (100BASE-TX) IEEE802.3ab (1000BASE-T)
	Note: To prevent risk of radio interference, use a Category-5e or higher shielded twisted pair cable.
	IEEE802.3az (Energy Efficient Ethernet); connected device should be IEEE802.3az compliant
Communication mode	Auto, 10Mbps Full duplex, 10Mbps Half duplex, 100Mbps Full duplex, 100Mbps Half duplex
Connector	RJ-45

Security Protocol

- IEEE802.1X (requires a connected device compliant with IEEE802.1X)
- IPsec/IP Filtering
- SSL/TLS; HTTPS Server/Client and IPPS
- SMTPS; STARTTLS and SSL/TLS
- SNMPv3

Parent topic: [Technical Specifications](#)

Network Interface Specifications (Latin America)

Note: Wireless LAN standard complies with either IEEE802.11b/g or IEEE802.11 b/g/n, depending on purchase location.

Wi-Fi

(Only available with the optional Wireless LAN interface.)

Standard	IEEE802.11b/g/n; complies with either IEEE802.11b/g or IEEE802.11b/g/n, depending on purchase location
-----------------	--

Frequency range	2.4 GHz
Channels	1/2/3/4/5/6/7/8/9/10/11/12/13
Maximum radio-frequency power transmitted	20 dBm (EIRP)
Connection modes	Infrastructure mode Wi-Fi Direct (Simple AP)
	Note: Wi-Fi Direct (Simple AP) mode not available for IEEE 802.11b.
Wireless security protocols	WEP (64/128 bit) WPA2-PSK (AES) compliant with WPA2 standards with support for WPA/WPA2 Personal WPA3-SAE (AES) WPA2/WPA3-Enterprise
Ethernet	
Standards	IEEE802.3i (10BASE-T) IEEE802.3u (100BASE-TX) IEEE802.3ab (1000BASE-T)
	Note: To prevent risk of radio interference, use a Category-5e or higher shielded twisted pair cable.
	IEEE802.3az (Energy Efficient Ethernet); connected device should be IEEE802.3az compliant
Communication mode	Auto, 10Mbps Full duplex, 10Mbps Half duplex, 100Mbps Full duplex, 100Mbps Half duplex
Connector	RJ-45
Security Protocol	
	<ul style="list-style-type: none"> • IEEE802.1X (requires a connected device compliant with IEEE802.1X) • IPsec/IP Filtering

- SSL/TLS; HTTPS Server/Client and IPPS
- SMTPS; STARTTLS and SSL/TLS
- SNMPv3

Parent topic: [Technical Specifications](#)

Safety and Approvals Specifications (U.S. and Canada)

United States

Safety: UL62368-1

EMC: FCC Part15 Subpart B Class B

Canada

Safety: CAN/CSA-C22.2 No. 62368-1

EMC: CAN ICES-3 (B)/NMB-3 (B)

This product conforms to Part 15 of FCC Rules and RSS-210 of the IC Rules. Epson cannot accept responsibility for any failure to satisfy the protection requirements resulting from a non-recommended modification of the product. Operation is subject to the following two conditions: (1) this device may not cause harmful interference, and (2) this device must accept any interference received, including interference that may cause undesired operation of the device.

To prevent radio interference to the licensed service, this device is intended to be operated indoors and away from windows to provide maximum shielding. Equipment (or its transmit antenna) that is installed outdoors is subject to licensing.

This equipment complies with FCC/IC radiation exposure limits set forth for an uncontrolled environment and meets the FCC radio frequency (RF) Exposure Guidelines in Supplement C to OET65 and RSS-102 of the IC radio frequency (RF) Exposure rules. This equipment should be installed and operated so that the radiator is kept at least 7.9 inches (20 cm) or more away from a person's body (excluding extremities: hands, wrists, feet and ankles).

Parent topic: [Technical Specifications](#)

Safety and Approvals Specifications (Latin America)

Notice for Peru

The following modules are not included with the printer and are optional accessories:

Printer Model: AM-C4000/AM-C5000/AM-C6000

WLAN Module: M359A

Brand: Epson

FCC ID: BKMFBM359A

Product Manufacturer: Seiko Epson Corporation

Address: 80 Harashinden, Hirooka Shiojiri-shi, Nagano, 399-0785, Japón

Fax Module: EU-237

Brand: Epson

FCC ID: BKMMM01AEU237

Product Manufacturer: Seiko Epson Corporation

Address: 3-5, Owa 3-chome, Suwa-shi, Nagano-ken 392-8502 Japón

Parent topic: [Technical Specifications](#)

Staple Finisher Specifications

Paper weight

14 to 80 lb (52 to 300 g/m²)

Note: When the paper thickness is 14 to 16 lb (52 to 59 g/m²) or 67 to 80 lb (251 to 300 g/m²), only standard (stacked) paper can be ejected to the tray under the finisher.

Paper type

Same as the paper loaded in the main unit

Available paper sizes

A3 (11.7 × 16.5 inches [297 × 420 mm])

A4 (8.3 × 11.7 inches [210 × 297 mm])

A5 (5.8 × 8.2 inches [148 × 210 mm])

A6 (4.1 × 5.8 inches [105 × 148 mm])

B4 (13.9 × 9.84 inches [353 × 250 mm])

B5 (7.2 × 10.1 inches [182 × 257 mm])

B6 (5 × 7.2 inches [128 × 182 mm])

Executive (7.25 × 10.5 inches [184 × 267 mm])

Half Letter (5.5 × 8.5 inches [140 × 216 mm])

Letter (8.5 × 11 inches [216 × 279 mm])

Legal (8.5 × 14 inches [216 × 356 mm])

8.5 × 13 inches (216 × 330 mm)

11 × 17 inches (279 × 432 mm)

12 × 18 inches (305 × 457 mm)

No. 10 (4.1 × 9.5 inches [105 × 241 mm])

All sizes are in landscape orientation. Letter (8.5 × 11 inches [216 × 279 mm]), A4 (8.3 × 11.7 inches [210 × 297 mm]), and B5 (7.2 × 10.1 inches [182 × 257 mm]) size papers also support portrait orientation.

Only user-defined sizes with a width between 4.13 and 11.7 inches (104.8 to 297 mm) and a length between 7.2 and 18 inches (182 to 457.2 mm) can use the finisher tray.

Only user-defined sizes with a width between 10.1 and 11.7 inches (257 to 297 mm) and a length between 7.1 and 47.2 inches (182 to 1200 mm) can use the top output tray.

Ejecting Capacity

Finisher tray

(17 to 21 lb [64 to 80g/m²])

Standard (Stack) Ejecting /Shift Ejecting /Punch

Without saddle stitch unit:

- A4/B5/Letter: 4000 sheets or less depending on the print pattern
- A3/B4/Legal 1-sided/2-sided: 1500 sheets
- A5/B6 1-sided/2-sided: 500 sheets

With saddle stitch unit:

- A4/B5/Letter: 3000 sheets or less depending on the print pattern
- A3/B4/Legal 1-sided/2-sided: 1500 sheets
- A5/B6 1-sided/2-sided: 500 sheets

Staple

Without saddle stitch unit:

- A4/B5/Letter: 80 sets or 4000 sheets (whichever occurs first)
- A3/B4/Legal 1-sided/2-sided: 50 sets or 1500 sheets (whichever occurs first)

With saddle stitch unit:

- A4/B5/Letter: 60 sets or 3000 sheets (whichever occurs first)
- A3/B4/Legal 1-sided/2-sided: 50 sets or 1500 sheets (whichever occurs first)

Output tray

200 sheets (17 to 21 lb [64 to 80g/m²])

Can only be specified as the fax output destination.

Top output tray

1 sheet (14 to 80 lb [52 to 300 g/m²])

Cannot be specified as the output tray. The output tray is specified automatically based on the settings.

Booklet tray (With auxiliary tray attached)

Saddle stitch

- Staple up to 5 sheets: 20 sets
- 6 to 20 sheets binding: 10 sets

Half fold

- 1 to 3 sheets: 20 sets

Tri fold

- 1 to 3 sheets: 20 sets

Shift Ejecting

Up to two sheets of 28 to 67 lb (106 to 250 g/m²) (one front cover and one back cover).

Tray: Finisher Tray

Available paper sizes

- A3 (11.7 × 16.5 inches [297 × 420 mm])
- A4 (8.3 × 11.7 inches [210 × 297 mm])
- B4 (13.9 × 9.84 inches [353 × 250 mm])
- B5 (7.2 × 10.1 inches [182 × 257 mm])
- Letter (8.5 × 11 inches [216 × 279 mm])
- Legal (8.5 × 14 inches [216 × 356 mm])
- 11 × 17 inches (279 × 432 mm)

All sizes are in landscape orientation. Letter (8.5 × 11 inches [216 × 279 mm]), A4 (8.3 × 11.7 inches [210 × 297 mm]), and B5 (7.2 × 10.1 inches [182 × 257 mm]) size papers also support portrait orientation.

Staple

Tray: Finisher Tray

Available paper sizes

- A3 (11.7 × 16.5 inches [297 × 420 mm])
- A4 (8.3 × 11.7 inches [210 × 297 mm])
- B4 (13.9 × 9.84 inches [353 × 250 mm])
- B5 (7.2 × 10.1 inches [182 × 257 mm])
- Letter (8.5 × 11 inches [216 × 279 mm])
- Legal (8.5 × 14 inches [216 × 356 mm])
- 11 × 17 inches (279 × 432 mm)
- 12 × 18 inches (305 × 457 mm)

Note: A4 and Letter-sized paper is also compatible in portrait orientation. B5-sized paper is only available in portrait orientation.

Staple position: One at the front, one at the back, and two at the edges

Note: B5 paper is not supported

Amount of available paper

16 to 24 lb (60 to 90 g/m²)

- A4/B5/Letter: 50 sheets
- A3/B4/Legal/11 × 17/12 × 18: 30 sheets

24 to 28 lb (91 to 105 g/m²)

- A4/B5/Letter: 40 sheets
- A3/B4/Legal/11 × 17/12 × 18: 20 sheets

28 to 67 lb (106 to 250 g/m²)

You can only use one sheet for the front and back cover.

Saddle stitch

(requires the bookbinder unit)

Tray: Booklet tray

Available paper sizes

- A3 (11.7 × 16.5 inches [297 × 420 mm])
- A4 (8.3 × 11.7 inches [210 × 297 mm])
- B4 (13.9 × 9.84 inches [353 × 250 mm])
- Letter (8.5 × 11 inches [216 × 279 mm])
- Legal (8.5 × 14 inches [216 × 356 mm])
- 11 × 17 inches (279 × 432 mm)

All sizes are in landscape orientation. Letter (8.5 × 11 inches [216 × 279 mm]), A4 (8.3 × 11.7 inches [210 × 297 mm]), and B5 (7.2 × 10.1 inches [182 × 257 mm]) size papers also support portrait orientation.

16 to 24 lb (60 to 90 g/m²): 20 sheets

24 to 28 lb (91 to 105 g/m²): 10 sheets

28 to 67 lb (106 to 250 g/m²): You can only use one sheet for the front cover.

Half fold

(requires the bookbinder unit)

Tray: Booklet tray

Available paper sizes (in landscape orientation)

- A3 (11.7 × 16.5 inches [297 × 420 mm])
- A4 (8.3 × 11.7 inches [210 × 297 mm])
- B4 (13.9 × 9.84 inches [353 × 250 mm])
- Letter (8.5 × 11 inches [216 × 279 mm])
- Legal (8.5 × 14 inches [216 × 356 mm])
- 11 × 17 inches (279 × 432 mm)

16 to 28 lb (60 to 105 g/m²): 3 sheets

28 to 67 lb (106 to 250 g/m²): You can only use one sheet for the front cover.

Tri fold
(requires the bookbinder unit)

Tray: Booklet tray

Available paper sizes (in landscape orientation)

- A4 (8.3 × 11.7 inches [210 × 297 mm])
 - Letter (8.5 × 11 inches [216 × 279 mm])
- 16 to 24 lb (60 to 90 g/m²): 20 sheets
24 to 28 lb (91 to 105 g/m²): 10 sheets

Punch
(requires the punch unit)

Tray: Finisher tray

Available paper sizes

- A3 (11.7 × 16.5 inches [297 × 420 mm])
- A4 (8.3 × 11.7 inches [210 × 297 mm])^{*1}
- A5 (5.8 × 8.2 inches [148 × 210 mm])^{*1}
- B4 (13.9 × 9.84 inches [353 × 250 mm])^{*2}
- B5 (7.2 × 10.1 inches [182 × 257 mm])^{*1*2}
- Letter (8.5 × 11 inches [216 × 279 mm])
- Legal (8.5 × 14 inches [216 × 356 mm])^{*1}
- 8.5 × 13 inches (216 × 330 mm)^{*1}
- 11 × 17 inches (279 × 432 mm)
- 12 × 18 inches (305 × 457 mm)

Punch position: 2-hole/4-hole, 2-hole/3-hole

Punch hole interval

- 2/4-Hole punch unit: 3.1 inches (80 mm)
- 2/3-Hole punch unit: 2.8 inches (70 mm) (2holes); 4.3 inches (108 mm) (3 holes)

Power supply rating

DC 24 V

Maximum power consumption

Staple Finisher: 209 W

Staple Finisher with Punch unit and Saddle stitch unit: 220 W

Dimensions

Width: 26.8 inches (681 mm)

Depth: 26.3 inches (669 mm)

Height: 41.8 inches (1062 mm)

Weight

Approximately 92.6 lbs (42 kg)

*1: Paper size in landscape orientation supports 2-hole punch only.

*2: B5 paper in portrait orientation and B4 paper in landscape orientation support 2-hole punch only.

Parent topic: [Technical Specifications](#)

Inner Finisher Specifications

Paper weight14 to 80 lb (52 to 300 g/m²)**Paper type**

Same as the paper loaded in the main unit

Available paper sizes

A3 (11.7 × 16.5 inches [297 × 420 mm])

A4 (8.3 × 11.7 inches [210 × 297 mm])

A5 (5.8 × 8.2 inches [148 × 210 mm])

A6 (4.1 × 5.8 inches [105 × 148 mm])

B4 (13.9 × 9.84 inches [353 × 250 mm])

B5 (7.2 × 10.1 inches [182 × 257 mm])

B6 (5 × 7.2 inches [128 × 182 mm])

Executive (7.25 × 10.5 inches [184 × 267 mm])

Half Letter (5.5 × 8.5 inches [140 × 216 mm])

Letter (8.5 × 11 inches [216 × 279 mm])

Legal (8.5 × 14 inches [216 × 356 mm])

8.5 × 13 inches (216 × 330 mm)

11 × 17 inches (279 × 432 mm)

12 × 18 inches (305 × 457 mm)

No. 10 (4.1 × 9.5 inches [105 × 241 mm])

All sizes are in landscape orientation. Letter (8.5 × 11 inches [216 × 279 mm]), A4 (8.3 × 11.7 inches [210 × 297 mm]), and B5 (7.2 × 10.1 inches [182 × 257 mm]) size papers also support portrait orientation.

Only user-defined sizes with a width between 4.13 and 11.7 inches (104.8 to 297 mm) and a length between 7.2 and 18 inches (182 to 457.2 mm) can use the inner finisher.

Ejecting Capacity

(17 to 21 lb [64 to 80g/m²])

Length less than 11.5 inches (298 mm): 500 sheets

Length more than 11.5 inches (298 mm): 300 sheets

Shift Ejecting

Available paper sizes

- A3 (11.7 × 16.5 inches [297 × 420 mm])
- A4 (8.3 × 11.7 inches [210 × 297 mm])
- B4 (13.9 × 9.84 inches [353 × 250 mm])
- B5 (7.2 × 10.1 inches [182 × 257 mm])
- Letter (8.5 × 11 inches [216 × 279 mm])
- Legal (8.5 × 14 inches [216 × 356 mm])
- 11 × 17 inches (279 × 432 mm)

All sizes are in landscape orientation. Letter (8.5 × 11 inches [216 × 279 mm]), A4 (8.3 × 11.7 inches [210 × 297 mm]), and B5 (7.2 × 10.1 inches [182 × 257 mm]) size papers also support portrait orientation.

Staple

Available paper sizes

- A3 (11.7 × 16.5 inches [297 × 420 mm])
- A4 (8.3 × 11.7 inches [210 × 297 mm])
- B4 (13.9 × 9.84 inches [353 × 250 mm])
- B5 (7.2 × 10.1 inches [182 × 257 mm])
- Letter (8.5 × 11 inches [216 × 279 mm])
- Legal (8.5 × 14 inches [216 × 356 mm])
- 11 × 17 inches (279 × 432 mm)
- 12 × 18 inches (305 × 457 mm)

Note: A4 and Letter-sized paper is also compatible in portrait orientation. B5-sized paper is only available in portrait orientation.

Staple position: One at the front, one at the back, and two at the edges

Note: B5 paper is not supported

Amount of available paper

16 to 24 lb (60 to 90 g/m²)

- A4/B5/Letter: 50 sheets
- A3/B4/Legal/11 × 17/12 × 18 : 30 sheets

24 to 28 lb (91 to 105 g/m²)

- A4/B5/Letter: 40 sheets
- A3/B4/Legal/11 × 17/12 × 18 : 20 sheets

28 to 67 lb (106 to 250 g/m²)

You can only use one sheet for the front and back cover.

Punch
(requires the punch unit)

Tray: Finisher tray

Available paper sizes

- A3 (11.7 × 16.5 inches [297 × 420 mm])
- A4 (8.3 × 11.7 inches [210 × 297 mm])^{*1}
- A5 (5.8 × 8.2 inches [148 × 210 mm])^{*1}
- B4 (13.9 × 9.84 inches [353 × 250 mm])^{*2}
- B5 (7.2 × 10.1 inches [182 × 257 mm])^{*1*2}
- Letter (8.5 × 11 inches [216 × 279 mm])
- Legal (8.5 × 14 inches [216 × 356 mm])^{*1}
- 8.5 × 13 inches (216 × 330 mm)^{*1}
- 11 × 17 inches (279 × 432 mm)
- 12 × 18 inches (305 × 457 mm)

Punch position: 2-hole/4-hole, 2-hole/3-hole

Punch hole interval

- 2/4-Hole punch unit: 3.1 inches (80 mm)
- 2/3-Hole punch unit: 2.8 inches (70 mm) (2 holes); 4.3 inches (108 mm) (3 holes)

Power supply rating

DC 24 V

Maximum power consumption

Inner Finisher: 167 W

Inner Finisher with Punch unit: 200 W

Dimensions

Width: 18.3 inches (466 mm)

Depth: 20.2 inches (512 mm)

Height: 8.3 inches (210 mm)

Weight

Approximately 28.7 lbs (13 kg)

^{*1}: Paper size in landscape orientation supports 2-hole punch only.

^{*2}: B5 paper in portrait orientation and B4 paper in landscape orientation support 2-hole punch only.

Parent topic: [Technical Specifications](#)

Super G3/G3 Multi Fax Board Specifications

Possible number of expansions 2 (3 in total with standard)

Note: Other specifications are the same as standard faxing. Follow the link below for more information.

Parent topic: [Technical Specifications](#)

10/100/1000 Base-T Ethernet Specifications

Follow the link below for more information.

Parent topic: [Technical Specifications](#)

Inner Tray Specifications

Available paper sizes The same as the paper sizes that can be loaded from the paper tray.

Ejecting capacity 100 sheets

Power supply rating DC 24 V

Maximum power consumption 16 W

Weight Approximately 4.0 lb (1.8 kg)

Parent topic: [Technical Specifications](#)

High-Capacity Unit Specifications

Available paper sizes Letter (8.5 × 11 inches [216 × 279 mm]), A4 (8.3 × 11.7 inches [210 × 297 mm])

Ejecting capacity 3000 sheets at 21 lb (80 g/m²)

Power supply rating DC 24 V

Maximum power consumption 18 W

Dimensions	Width: 13.8 inches (351 mm) Depth: 23.0 inches (585 mm) Height: 18.3 inches (465 mm)
Weight	Approximately 55.2 lb (25 kg)

Parent topic: [Technical Specifications](#)

Optional Dual Cassette Specifications

Available paper sizes	Follow the link below for available paper sizes.
Capacity	Maximum 550 sheets
Power supply rating	DC 24 V
Maximum power consumption	11 W
Dimensions	Width: 21.9 inches (555 mm) Depth: 23.3 inches (593 mm) Height: 12.1 inches (307 mm)
Weight	Approximately 54.9 lb (24.9 kg)

Parent topic: [Technical Specifications](#)

HDD Specifications

Purpose	Mirroring the internal storage
----------------	--------------------------------

Immediately after installing the additional HDD, a preparation message is displayed at the bottom right of the control panel. You can use the printer while it is displayed, but we recommend that you wait about one to two hours until it disappears.

The specifications are the same as the internal storage. See the link below for details.

Parent topic: [Technical Specifications](#)

Notices

Check these sections for important notices about your product.

Note: Epson offers a recycling program for end of life Epson products. Please go to [this site](#) (U.S.) or [this site](#) (Canada) for information on how to return your Epson products for proper disposal.

[Important Safety Instructions](#)

[FCC Compliance Statement](#)

[Binding Arbitration and Class Waiver](#)

[Trademarks](#)

[Copyright Notice](#)

Important Safety Instructions

Before using your Epson product, read and follow these safety instructions.

[General Product Safety Instructions](#)

[Ink Cartridge Safety Instructions](#)

[Wireless Connection Safety Instructions](#)

[LCD Screen Safety Instructions](#)

[Telephone Equipment Safety Instructions](#)

Parent topic: [Notices](#)

General Product Safety Instructions

- Be sure to follow all warnings and instructions marked on the product.
- Use only the type of power source indicated on the product's label.
- Use only the power cord that comes with the product. Do not use the cord with any other equipment. Using another cord or using the provided cord with other equipment may cause fires or shock.
- Make sure the AC power cord meets the relevant local safety standard.
- Place the product near a wall outlet where the plug can be easily unplugged.
- Avoid plugging the product into an outlet on the same circuit as a photo copier or air control system that regularly switches on and off, or on an outlet controlled by a wall switch or timer.

- Do not let the power cord become damaged or frayed. Place it to avoid abrasions, cuts, fraying, crimping, and kinking. Do not place objects on top of it and do not allow it to be stepped on or run over. Be careful to keep the cord straight at each end.
- If you use an extension cord with the product, make sure the total ampere rating of the devices plugged into the extension cord does not exceed the cord's ampere rating. Also, make sure the total ampere rating of all devices plugged into the wall outlet does not exceed the wall outlet's ampere rating.
- Always turn off the product using the power button, and wait until the power light stops flashing before unplugging the product or cutting off power to the electrical outlet.
- If you will not be using the product for a long period, unplug the power cord from the electrical outlet.
- Place the product on a flat, stable surface that extends beyond its base in all directions. It will not operate properly if it is tilted or at an angle.
- Allow space behind the product for the cables, and space above the product so that you can fully raise the document cover.
- Leave enough space in front of the product for the paper to be fully ejected.
- Leave enough space in front and on the sides of the product for printing and maintenance.
- Allow enough space above the unit to fully raise the ADF.
- Avoid locations that are subject to rapid changes in heat or humidity, shocks or vibrations, or dust.
- Do not place or store the product outdoors.
- Do not place the product near excessive heat sources or in direct sunlight.
- Leave enough room around the product for sufficient ventilation. Do not block or cover openings in the case or insert objects through the slots.
- Keep the product away from potential sources of electromagnetic interference, such as loudspeakers or the base units of cordless telephones.
- When connecting the product to a computer or other device with a cable, ensure the correct orientation of the connectors. Each connector has only one correct orientation. Inserting a connector in the wrong orientation may damage both devices connected by the cable.
- Do not sit or lean on the product. Do not place heavy objects on the product.
- Do not move the print head by hand; this may damage the product.
- Do not put your hands inside the product while it is printing.
- Do not spill liquid on the product or use the product with wet hands.

- Do not use aerosol products that contain flammable gases inside or around the product. Doing so may cause fire.
- Do not press too hard on the scanner glass when placing originals.
- Do not open the scanner section while the product is copying, printing, scanning, or performing any other functions.
- Be careful not to trap your fingers when opening the covers, trays, cassettes, or when performing operations inside the product.
- Avoid touching the components inside the product unless as specifically instructed to do so in this guide.
- Except as specifically explained in your documentation, do not attempt to service or disassemble the product yourself.
- Unplug the product and refer servicing to qualified service personnel under the following conditions: if the power cord or plug is damaged; if liquid has entered the product; if the product has been dropped or the case damaged; if the product does not operate normally or exhibits a distinct change in performance. Adjust only those controls that are covered by the operating instructions.
- When storing or transporting the product, do not tilt it, stand it on its side, or turn it upside down; otherwise, ink may leak.
- Do not attempt to move the product by yourself.
- Do not touch the areas indicated by caution labels inside the product and any optional items.

Parent topic: [Important Safety Instructions](#)

Ink Cartridge Safety Instructions

- Keep ink cartridges out of the reach of children and do not drink the ink.
- Be careful when you handle used ink cartridges; there may be ink remaining around the ink supply port. If ink gets on your skin, wash it off with soap and water. If it gets in your eyes, flush them immediately with water.
- Do not put your hand inside the product or touch any cartridges during printing.
- Install a new ink cartridge immediately after removing an expended one. Leaving cartridges uninstalled can dry out the print head and may prevent the product from printing.
- Do not remove or tear the label on the cartridge; this can cause leakage.
- Do not remove the transparent seal from the bottom of the cartridge. This may cause the cartridge to become unusable.
- Do not break the hooks on the side of the cartridge when removing it from the packaging.

- Do not touch the green IC chip on the side of the cartridge. This may prevent normal operation.
- If you remove an ink cartridge for later use, protect the ink supply area from dirt and dust and store it in the same environment as the product. Note that there is a valve in the ink supply port, making covers or plugs unnecessary, but care is needed to prevent the ink from staining items that the cartridge touches. Do not touch the ink cartridge ink supply port or surrounding area.
- Use an ink cartridge before the date printed on its package.
- Do not dismantle an ink cartridge. This could damage the print head.
- Store ink cartridges in a cool, dark place; do not store the ink cartridges in high or freezing temperatures.

Parent topic: [Important Safety Instructions](#)

Wireless Connection Safety Instructions

Radio waves from this product may adversely affect the operation of medical equipment or automatically controlled devices, such as pacemakers, automatic doors or fire alarms. When using this product near such devices or inside a medical facility, follow the directions from authorized staff members at the facility, and follow all posted warnings and directions on the device to avoid causing an accident.

Parent topic: [Important Safety Instructions](#)

LCD Screen Safety Instructions

- Use only a dry, soft cloth to clean the LCD screen. Do not use liquid or chemical cleansers.
- If the LCD screen is damaged, contact Epson. If the liquid crystal solution gets on your hands, wash them thoroughly with soap and water. If the liquid crystal solution gets into your eyes, flush them immediately with water. If discomfort or vision problems remain after a thorough flushing, see a doctor immediately.
- Do not press too hard on the LCD screen or subject it to heavy impacts.
- Do not use a pointy or sharp object, such as a pen or your fingernail, to operate the LCD screen.
- If the LCD screen chips or cracks, do not touch or attempt to remove the broken pieces; contact Epson for support.
- Do not subject your product to sudden changes in temperature or humidity; this may cause condensation to develop inside the LCD screen and degrade its performance.
- The LCD screen may contain a few small bright or dark spots, and may display uneven brightness. These are normal and do not indicate that the screen is damaged in any way.

Parent topic: [Important Safety Instructions](#)

Telephone Equipment Safety Instructions

When using telephone equipment, you should always follow basic safety precautions to reduce the risk of fire, electric shock, and personal injury, including the following:

- Do not use the Epson product near water.
- Avoid using a telephone during an electrical storm. There may be a remote risk of electric shock from lightning.
- Do not use a telephone to report a gas leak in the vicinity of the leak.

Caution: To reduce the risk of fire, use only a No. 26 AWG or larger telecommunication line cord.

Parent topic: [Important Safety Instructions](#)

FCC Compliance Statement

For United States Users

This equipment has been tested and found to comply with the limits for a Class B digital device, pursuant to Part 15 of the FCC Rules. These limits are designed to provide reasonable protection against harmful interference in a residential installation. This equipment generates, uses, and can radiate radio frequency energy and, if not installed and used in accordance with the instructions, may cause harmful interference to radio or television reception. However, there is no guarantee that interference will not occur in a particular installation. If this equipment does cause interference to radio and television reception, which can be determined by turning the equipment off and on, the user is encouraged to try to correct the interference by one or more of the following measures:

- Reorient or relocate the receiving antenna.
- Increase the separation between the equipment and receiver.
- Connect the equipment into an outlet on a circuit different from that to which the receiver is connected.
- Consult the dealer or an experienced radio/TV technician for help.

WARNING

The connection of a non-shielded equipment interface cable to this equipment will invalidate the FCC Certification or Declaration of this device and may cause interference levels which exceed the limits established by the FCC for this equipment. It is the responsibility of the user to obtain and use a shielded equipment interface cable with this device. If this equipment has more than one interface connector, do not leave cables connected to unused interfaces. Changes or modifications not expressly approved by the manufacturer could void the user's authority to operate the equipment.

For Canadian Users

CAN ICES-3(B)/NMB-3(B)

Parent topic: [Notices](#)

Binding Arbitration and Class Waiver

1. DISPUTES, BINDING INDIVIDUAL ARBITRATION, AND WAIVER OF CLASS ACTIONS AND CLASS ARBITRATIONS

1.1 Disputes. The terms of this Section 1 shall apply to all Disputes between you and Epson. The term "Dispute" is meant to have the broadest meaning permissible under law and includes any dispute, claim, controversy or action between you and Epson arising out of or relating to this Agreement, Epson branded products (hardware and including any related software), or other transaction involving you and Epson, whether in contract, warranty, misrepresentation, fraud, tort, intentional tort, statute, regulation, ordinance, or any other legal or equitable basis. "DISPUTE" DOES NOT INCLUDE IP CLAIMS, or more specifically, a claim or cause of action for (a) trademark infringement or dilution, (b) patent infringement, (c) copyright infringement or misuse, or (d) trade secret misappropriation (an "IP Claim"). You and Epson also agree, notwithstanding Section 1.6, that a court, not an arbitrator, may decide if a claim or cause of action is for an IP Claim.

1.2 Binding Arbitration. You and Epson agree that all Disputes shall be resolved by binding arbitration according to this Agreement. **ARBITRATION MEANS THAT YOU WAIVE YOUR RIGHT TO A JUDGE OR JURY IN A COURT PROCEEDING AND YOUR GROUNDS FOR APPEAL ARE LIMITED.** Pursuant to this Agreement, binding arbitration shall be administered by JAMS, a nationally recognized arbitration authority, pursuant to its code of procedures then in effect for consumer related disputes, but excluding any rules that permit joinder or class actions in arbitration (for more detail on procedure, see Section 1.6 below). You and Epson understand and agree that (a) the Federal Arbitration Act (9 U.S.C. §1, et seq.) governs the interpretation and enforcement of this Section 1, (b) this Agreement memorializes a transaction in interstate commerce, and (c) this Section 1 shall survive termination of this Agreement.

1.3 Pre-Arbitration Steps and Notice. Before submitting a claim for arbitration, you and Epson agree to try, for sixty (60) days, to resolve any Dispute informally. If Epson and you do not reach an agreement to resolve the Dispute within the sixty (60) days, you or Epson may commence an arbitration. Notice to Epson must be addressed to: Epson America, Inc., ATTN: Legal Department, 3131 Katella Ave., Los Alamitos, CA 90720 (the "Epson Address"). The Dispute Notice to you will be sent to the most recent address Epson has in its records for you. For this reason, it is important to notify us if your address changes by emailing us at EAlegal@ea.epson.com or writing us at the Epson Address above. Notice of the Dispute shall include the sender's name, address and contact information, the facts giving rise to the Dispute, and the relief requested (the "Dispute Notice"). Following receipt of the Dispute Notice, Epson and you agree to act in good faith to resolve the Dispute before commencing arbitration.

1.4 Small Claims Court. Notwithstanding the foregoing, you may bring an individual action in the small claims court of your state or municipality if the action is within that court's jurisdiction and is pending only in that court.

1.5 WAIVER OF CLASS ACTIONS AND CLASS ARBITRATIONS. YOU AND EPSON AGREE THAT EACH PARTY MAY BRING DISPUTES AGAINST THE OTHER PARTY ONLY IN AN INDIVIDUAL CAPACITY, AND NOT AS A PLAINTIFF OR CLASS MEMBER IN ANY CLASS OR REPRESENTATIVE PROCEEDING, INCLUDING WITHOUT LIMITATION FEDERAL OR STATE CLASS ACTIONS, OR CLASS ARBITRATIONS. CLASS ACTION LAWSUITS, CLASS-WIDE ARBITRATIONS, PRIVATE ATTORNEY-GENERAL ACTIONS, AND ANY OTHER PROCEEDING WHERE SOMEONE ACTS IN A REPRESENTATIVE CAPACITY ARE NOT ALLOWED. ACCORDINGLY, UNDER THE ARBITRATION PROCEDURES OUTLINED IN THIS SECTION, AN ARBITRATOR SHALL NOT COMBINE OR CONSOLIDATE MORE THAN ONE PARTY'S CLAIMS WITHOUT THE WRITTEN CONSENT OF ALL AFFECTED PARTIES TO AN ARBITRATION PROCEEDING.

1.6 Arbitration Procedure. If you or Epson commences arbitration, the arbitration shall be governed by the rules of JAMS that are in effect when the arbitration is filed, excluding any rules that permit arbitration on a class or representative basis (the "JAMS Rules"), available at <http://www.jamsadr.com> or by calling 1-800-352-5267, and under the rules set forth in this Agreement. All Disputes shall be resolved by a single neutral arbitrator, and both parties shall have a reasonable opportunity to participate in the selection of the arbitrator. The arbitrator is bound by the terms of this Agreement. The arbitrator, and not any federal, state or local court or agency, shall have exclusive authority to resolve all disputes arising out of or relating to the interpretation, applicability, enforceability or formation of this Agreement, including any claim that all or any part of this Agreement is void or voidable. Notwithstanding this broad delegation of authority to the arbitrator, a court may determine the limited question of whether a claim or cause of action is for an IP Claim, which is excluded from the definition of "Disputes" in Section 1.1 above. The arbitrator shall be empowered to grant whatever relief would be available in a court under law or in equity. The arbitrator may award you the same damages as a court could, and may award declaratory or injunctive relief only in favor of the individual party seeking relief and only to the extent necessary to provide relief warranted by that party's individual claim. In some instances, the costs of arbitration can exceed the costs of litigation and the right to discovery may be more limited in arbitration than in court. The arbitrator's award is binding and may be entered as a judgment in any court of competent jurisdiction.

You may choose to engage in arbitration hearings by telephone. Arbitration hearings not conducted by telephone shall take place in a location reasonably accessible from your primary residence, or in Orange County, California, at your option.

a) Initiation of Arbitration Proceeding. If either you or Epson decides to arbitrate a Dispute, both parties agree to the following procedure:

(i) Write a Demand for Arbitration. The demand must include a description of the Dispute and the amount of damages sought to be recovered. You can find a copy of a Demand for Arbitration at <http://www.jamsadr.com> ("Demand for Arbitration").

(ii) Send three copies of the Demand for Arbitration, plus the appropriate filing fee, to: JAMS, 500 North State College Blvd., Suite 600 Orange, CA 92868, U.S.A.

(iii) Send one copy of the Demand for Arbitration to the other party (same address as the Dispute Notice), or as otherwise agreed by the parties.

b) Hearing Format. During the arbitration, the amount of any settlement offer made shall not be disclosed to the arbitrator until after the arbitrator determines the amount, if any, to which you or Epson is entitled. The discovery or exchange of non-privileged information relevant to the Dispute may be allowed during the arbitration.

c) Arbitration Fees. Epson shall pay, or (if applicable) reimburse you for, all JAMS filings and arbitrator fees for any arbitration commenced (by you or Epson) pursuant to provisions of this Agreement.

d) Award in Your Favor. For Disputes in which you or Epson seeks \$75,000 or less in damages exclusive of attorney's fees and costs, if the arbitrator's decision results in an award to you in an amount greater than Epson's last written offer, if any, to settle the Dispute, Epson will: (i) pay you \$1,000 or the amount of the award, whichever is greater; (ii) pay you twice the amount of your reasonable attorney's fees, if any; and (iii) reimburse you for any expenses (including expert witness fees and costs) that your attorney reasonably accrues for investigating, preparing, and pursuing the Dispute in arbitration. Except as agreed upon by you and Epson in writing, the arbitrator shall determine the amount of fees, costs, and expenses to be paid by Epson pursuant to this Section 1.6d).

e) Attorney's Fees. Epson will not seek its attorney's fees and expenses for any arbitration commenced involving a Dispute under this Agreement. Your right to attorney's fees and expenses under Section 1.6d) above does not limit your rights to attorney's fees and expenses under applicable law; notwithstanding the foregoing, the arbitrator may not award duplicative awards of attorney's fees and expenses.

1.7 Opt-out. You may elect to opt-out (exclude yourself) from the final, binding, individual arbitration procedure and waiver of class and representative proceedings specified in this Agreement by sending a written letter to the Epson Address within thirty (30) days of your assent to this Agreement (including without limitation the purchase, download, installation of the Software or other applicable use of Epson Hardware, products and services) that specifies (i) your name, (ii) your mailing address, and (iii) your request to be excluded from the final, binding individual arbitration procedure and waiver of class and representative proceedings specified in this Section 1. In the event that you opt-out consistent with the procedure set forth above, all other terms shall continue to apply, including the requirement to provide notice prior to litigation.

1.8 Amendments to Section 1. Notwithstanding any provision in this Agreement to the contrary, you and Epson agree that if Epson makes any future amendments to the dispute resolution procedure and

class action waiver provisions (other than a change to Epson's address) in this Agreement, Epson will obtain your affirmative assent to the applicable amendment. If you do not affirmatively assent to the applicable amendment, you are agreeing that you will arbitrate any Dispute between the parties in accordance with the language of this Section 1 (or resolve disputes as provided for in Section 1.7, if you timely elected to opt-out when you first assented to this Agreement).

1.9 Severability. If any provision in this Section 1 is found to be unenforceable, that provision shall be severed with the remainder of this Agreement remaining in full force and effect. **The foregoing shall not apply to the prohibition against class or representative actions as provided in Section 1.5. This means that if Section 1.5 is found to be unenforceable, the entire Section 1 (but only Section 1) shall be null and void.**

Parent topic: [Notices](#)

Trademarks

EPSON® and Epson Smart Panel are registered trademarks, the EPSON logo is a registered logomark, and Epson Connect™ and Remote Print™ are trademarks of Seiko Epson Corporation.

Mac, macOS, OS X, Bonjour, ColorSync, AirPrint, iPad, iPhone, and iPod touch are trademarks of Apple Inc., registered in the U.S. and other countries.

Use of the Works with Apple badge means that an accessory has been designed to work specifically with the technology identified in the badge and has been certified by the developer to meet Apple performance standards.

Google® is a registered trademark and Android™, Gmail™, Google Chrome™, Google Drive™, and Google Play™ are trademarks of Google LLC.

Microsoft and Windows are trademarks of the Microsoft group of companies.

Wi-Fi Direct® is a registered trademark of Wi-Fi Alliance®.

General Notice: Other product names used herein are for identification purposes only and may be trademarks of their respective owners. Epson disclaims any and all rights in those marks.

EPSON®

Parent topic: [Notices](#)

Copyright Notice

All rights reserved. No part of this publication may be reproduced, stored in a retrieval system, or transmitted in any form or by any means, electronic, mechanical, photocopying, recording, or otherwise, without the prior written permission of Seiko Epson Corporation. The information contained herein is

designed only for use with this Epson product. Epson is not responsible for any use of this information as applied to other products.

Neither Seiko Epson Corporation nor its affiliates shall be liable to the purchaser of this product or third parties for damages, losses, costs, or expenses incurred by purchaser or third parties as a result of: accident, misuse, or abuse of this product or unauthorized modifications, repairs, or alterations to this product, or (excluding the U.S.) failure to strictly comply with Seiko Epson Corporation's operating and maintenance instructions.

Seiko Epson Corporation shall not be liable for any damages or problems arising from the use of any options or any consumable products other than those designated as Original Epson Products or Epson Approved Products by Seiko Epson Corporation.

Seiko Epson Corporation shall not be held liable for any damage resulting from electromagnetic interference that occurs from the use of any interface cables other than those designated as Epson approved Products by Seiko Epson Corporation.

This information is subject to change without notice.

[libTIFF Software Acknowledgment](#)

[A Note Concerning Responsible Use of Copyrighted Materials](#)

[Default Delay Times for Power Management for Epson Products](#)

[Copyright Attribution](#)

Parent topic: [Notices](#)

libTIFF Software Acknowledgment

Copyright © 1988-1997 Sam Leffler

Copyright © 1991-1997 Silicon Graphics, Inc.

Permission to use, copy, modify, distribute, and sell this software and its documentation for any purpose is hereby granted without fee, provided that (i) the above copyright notices and this permission notice appear in all copies of the software and related documentation, and (ii) the names of Sam Leffler and Silicon Graphics may not be used in any advertising or publicity relating to the software without the specific, prior written permission of Sam Leffler and Silicon Graphics.

THE SOFTWARE IS PROVIDED "AS-IS" AND WITHOUT WARRANTY OF ANY KIND, EXPRESS, IMPLIED OR OTHERWISE, INCLUDING WITHOUT LIMITATION, ANY WARRANTY OF MERCHANTABILITY OR FITNESS FOR A PARTICULAR PURPOSE.

IN NO EVENT SHALL SAM LEFFLER OR SILICON GRAPHICS BE LIABLE FOR ANY SPECIAL, INCIDENTAL, INDIRECT OR CONSEQUENTIAL DAMAGES OF ANY KIND, OR ANY DAMAGES WHATSOEVER RESULTING FROM LOSS OF USE, DATA OR PROFITS, WHETHER OR NOT

ADVISED OF THE POSSIBILITY OF DAMAGE, AND ON ANY THEORY OF LIABILITY, ARISING OUT OF OR IN CONNECTION WITH THE USE OR PERFORMANCE OF THIS SOFTWARE.

Parent topic: [Copyright Notice](#)

A Note Concerning Responsible Use of Copyrighted Materials

Epson encourages each user to be responsible and respectful of the copyright laws when using any Epson product. While some countries' laws permit limited copying or reuse of copyrighted material in certain circumstances, those circumstances may not be as broad as some people assume. Contact your legal advisor for any questions regarding copyright law.

Parent topic: [Copyright Notice](#)

Default Delay Times for Power Management for Epson Products

This product will enter sleep mode after a period of nonuse. This is to ensure that the product meets Energy Star standards of energy efficiency. More energy savings can be achieved by setting the time to sleep to a shorter interval.

Parent topic: [Copyright Notice](#)

Copyright Attribution

© 2023 Epson America, Inc.

11/23

CPD-62840

Parent topic: [Copyright Notice](#)